



Project Number: U2716-0366-231

April 24, 2024

Sunmodo
14800 NE 65th Street
Vancouver, WA 98682

**REFERENCE: Sunmodo Sunturf Ground Mount B7 – Standard Panels
Ground Mount PV Array Installation**

To Whom It May Concern:

Per request of Sunmodo, we have been asked to prepare the structural design of a ground-mounted PV solar array system with several foundation options as shown in the attached calculations. Vector Structural Engineering requires that we review each site-specific install, and we are not liable for installs at site specific locations we have not reviewed. This document does not address site-specific installations. The following design parameters are used in our analysis:

- Code: International Building Code, 2018 Edition (2018 IBC)
- Minimum Design Loads for Buildings and Other Structures (ASCE 7-16)
- Design wind speed for risk category I structures: 105 mph
- Wind exposure: C
- Ground snow load: 50 psf
- The ground screws and helical piers must be tested to 1.5 times uplift and 2.0 times lateral reactions found in the table below. A minimum of one ground screw or helical pier must be tested.

Load (ASD)	Value (lbs)	Factor of Safety	Test Value (lbs)
UPLIFT	1560	1.5	2340
LATERAL	1123	2	2246

Foundation concrete shall have a minimum compressive strength of 2500 psi at 28 days. Cement for all concrete shall be Type I or II with a minimum of 6% entrained air with a water/cement ratio of 0.50. Maximum aggregate size shall be 3/4". No special inspection of concrete strength is required.

Footings are designed based on an allowable soil bearing pressure of 1500 psf an allowable skin friction of 250 psf, an allowable lateral bearing pressure of 150 pcf, and a coefficient of friction of 0.3. Vector Structural Engineering strongly recommends independent soils testing be performed by a licensed geotechnical engineer to verify the assumed soil parameters.

All ground mounts are to be installed per manufacturer’s recommendations. The use of solar panel support span tables provided by the manufacturer is allowed only where the site conditions and solar panel configuration match the description of the span tables. Electrical engineering is beyond our scope. All work performed must be in accordance with accepted industry-wide methods and applicable safety standards. Vector Structural Engineering assumes no responsibility for improper installation of the solar panels.

Very truly yours,

VECTOR STRUCTURAL ENGINEERING, LLC
MO Firm License #: 2011009604

Joel Hartman, P.E.
Project Engineer

Enclosures

JRH/mih

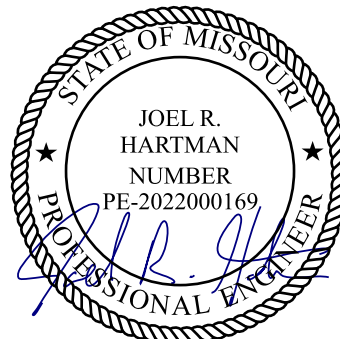

04/24/2024



JOB NO. U2716-0366-231
 PROJECT SUNMODO SUNTURF GROUND MOUNTS B7
 SUBJECT ALL OPTIONS

651 W GALENA PARK BLVD. #101 (801) 990-1775
 DRAPER, UTAH 84020 (801) 990-1776 FAX

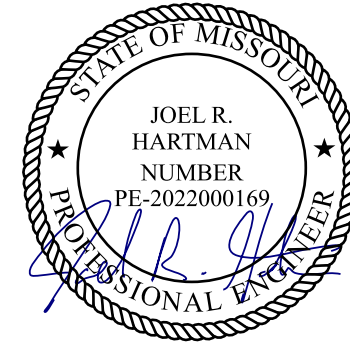

04/24/2024

Vector Structural Engineering requires that we review each site-specific install, and we are not liable for installs at site-specific locations we have not reviewed. This document does not address site-specific installations.

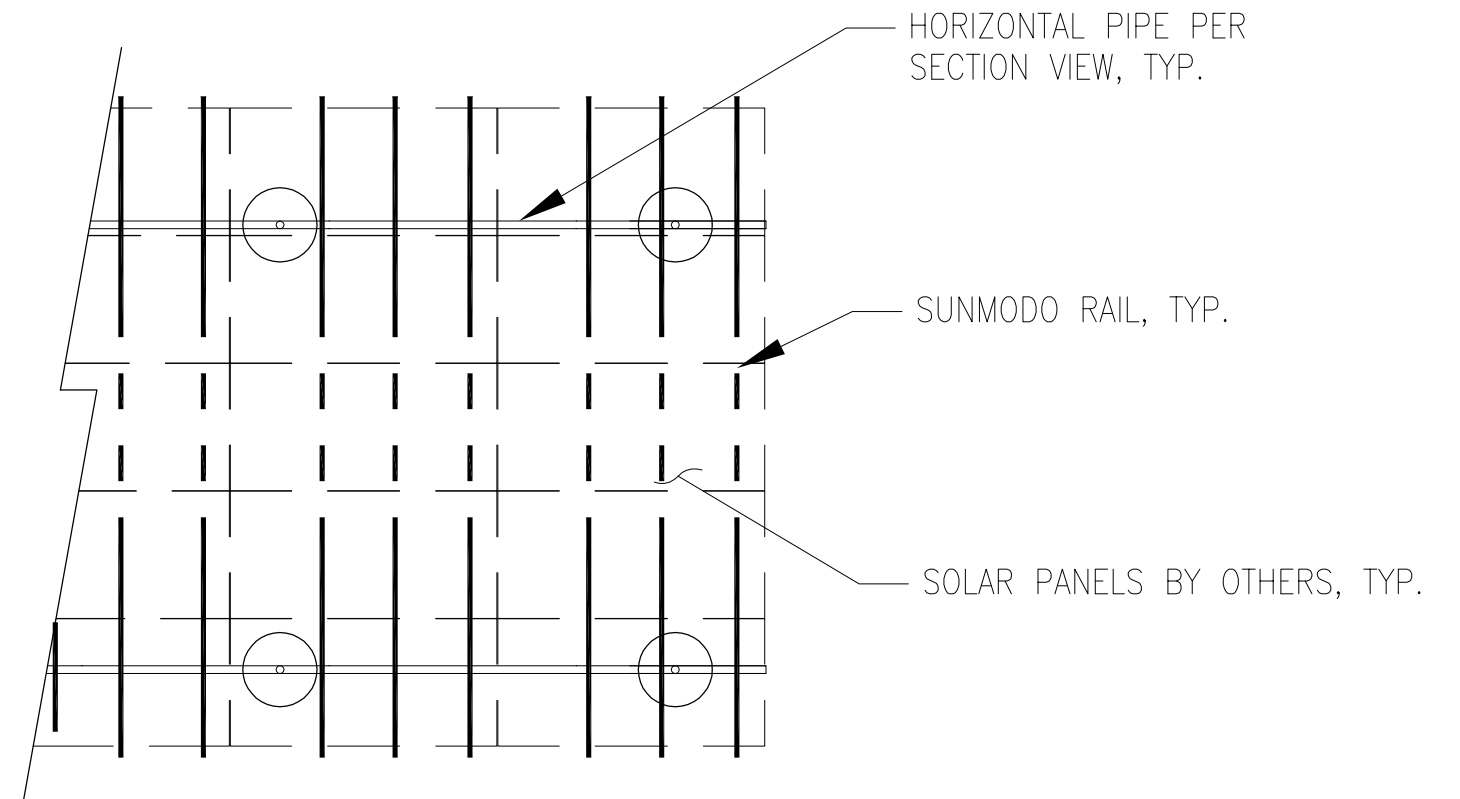
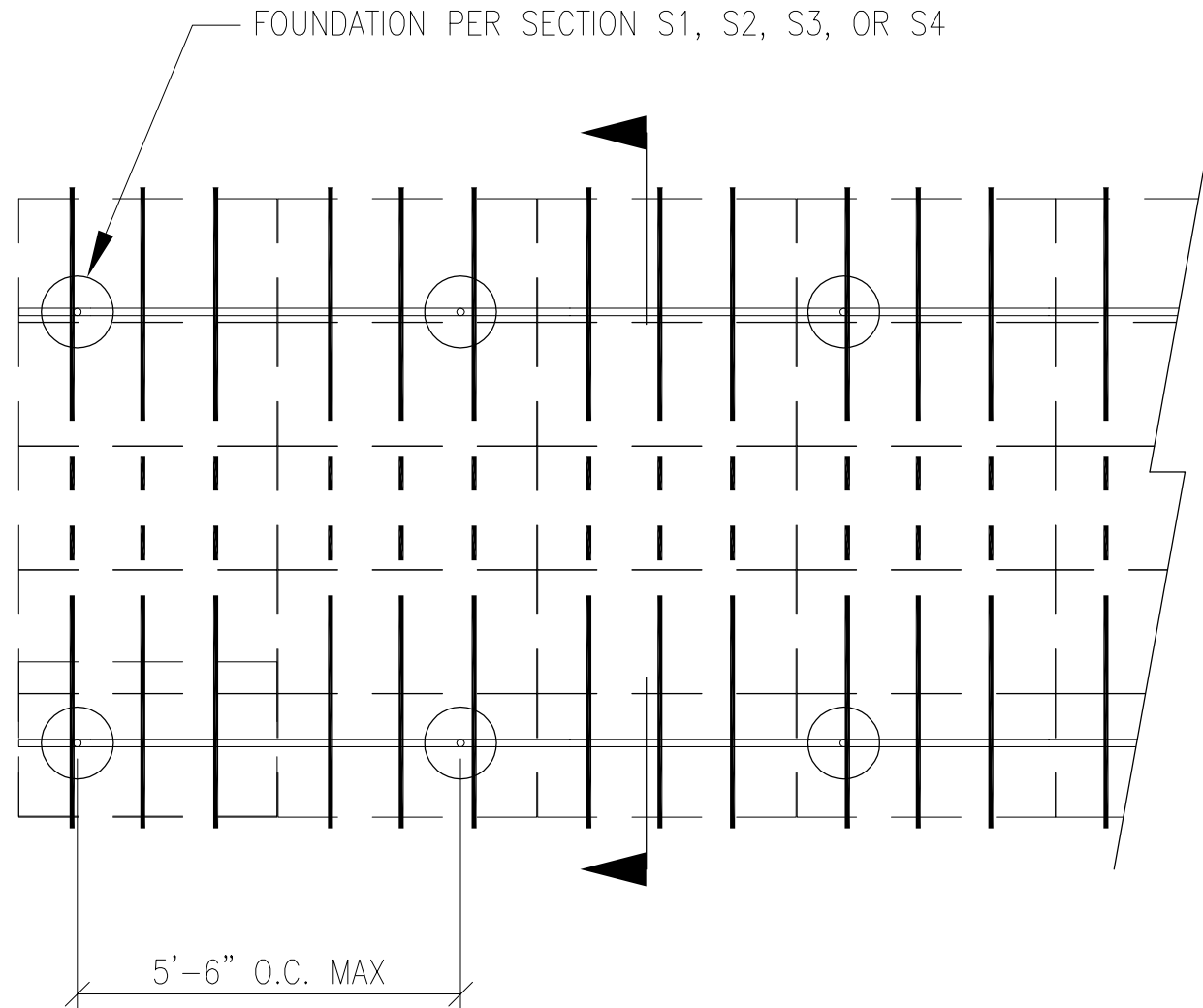

PV ARRAY PLAN

N.T.S.

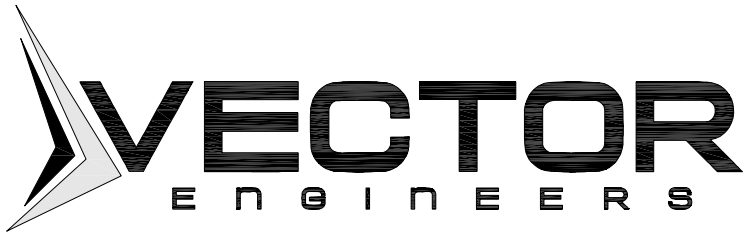

JOB NO. U2716-0366-231

PROJECT SUNMODO SUNTURF GROUND MOUNTS B7

SUBJECT DRILLED PIER OPTION

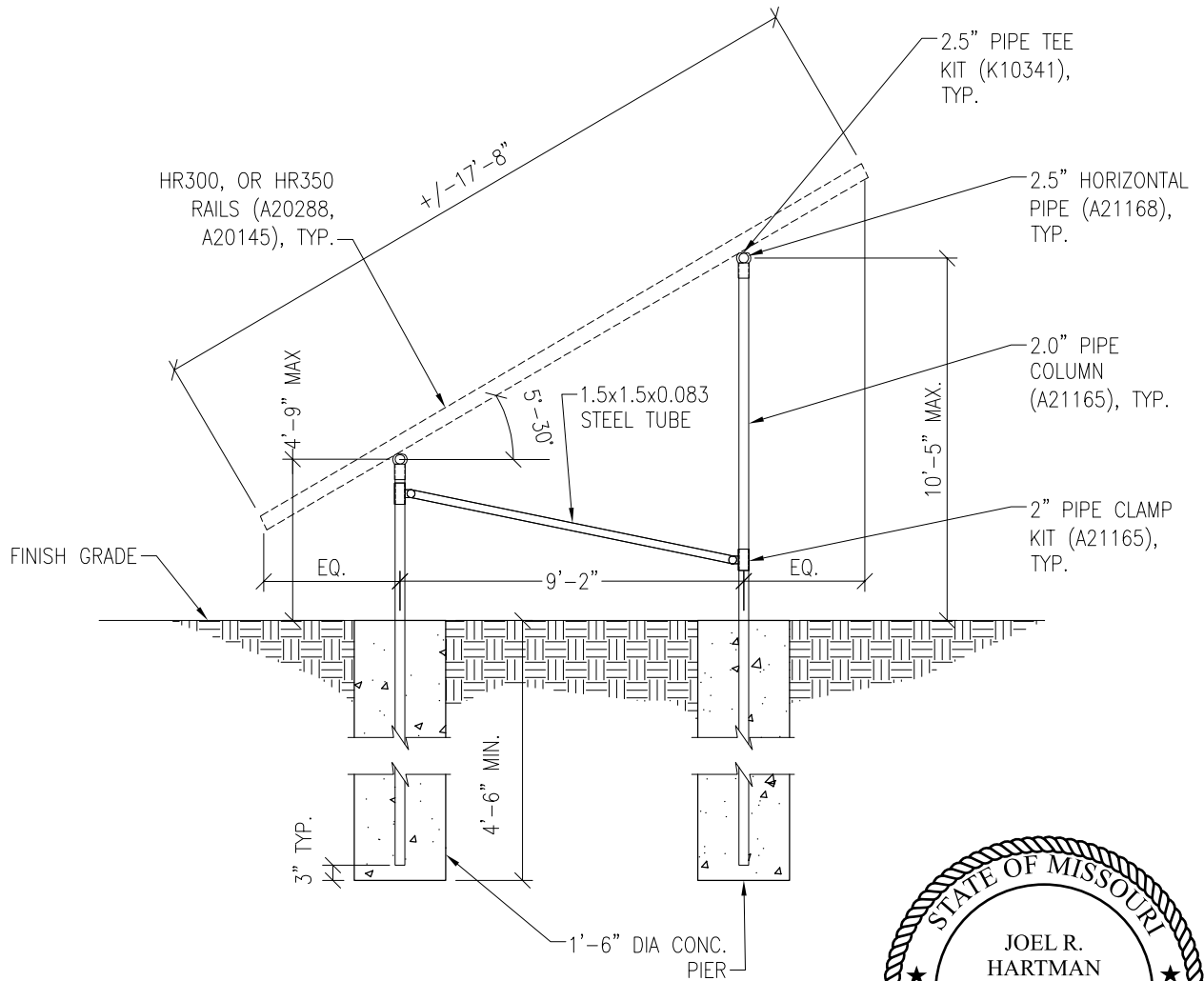

Vector Structural Engineering requires that we review each site-specific install, and we are not liable for installs at site-specific locations we have not reviewed. This document does not address site-specific installations.



PV ARRAY SECTION
N.T.S.

04/24/2024

S1

PROJECT SUNMODO SUNTURF GROUND MOUNTS B7

SUBJECT HELICAL PIER OPTION

NOTES:

1. For ground mount components see Section S1.
2. A minimum of (1) installed helical pier must be tested as follows:
 - 2.1. Safety factor for uplift to be 1.5
 - 2.2. S.F. for lateral loads to be 2.0
 - 2.3. Upward deflection limit = 1/2"
 - 2.4. Lateral deflection limit = 1"
 - 2.5. The load tests must be performed by an approved contractor

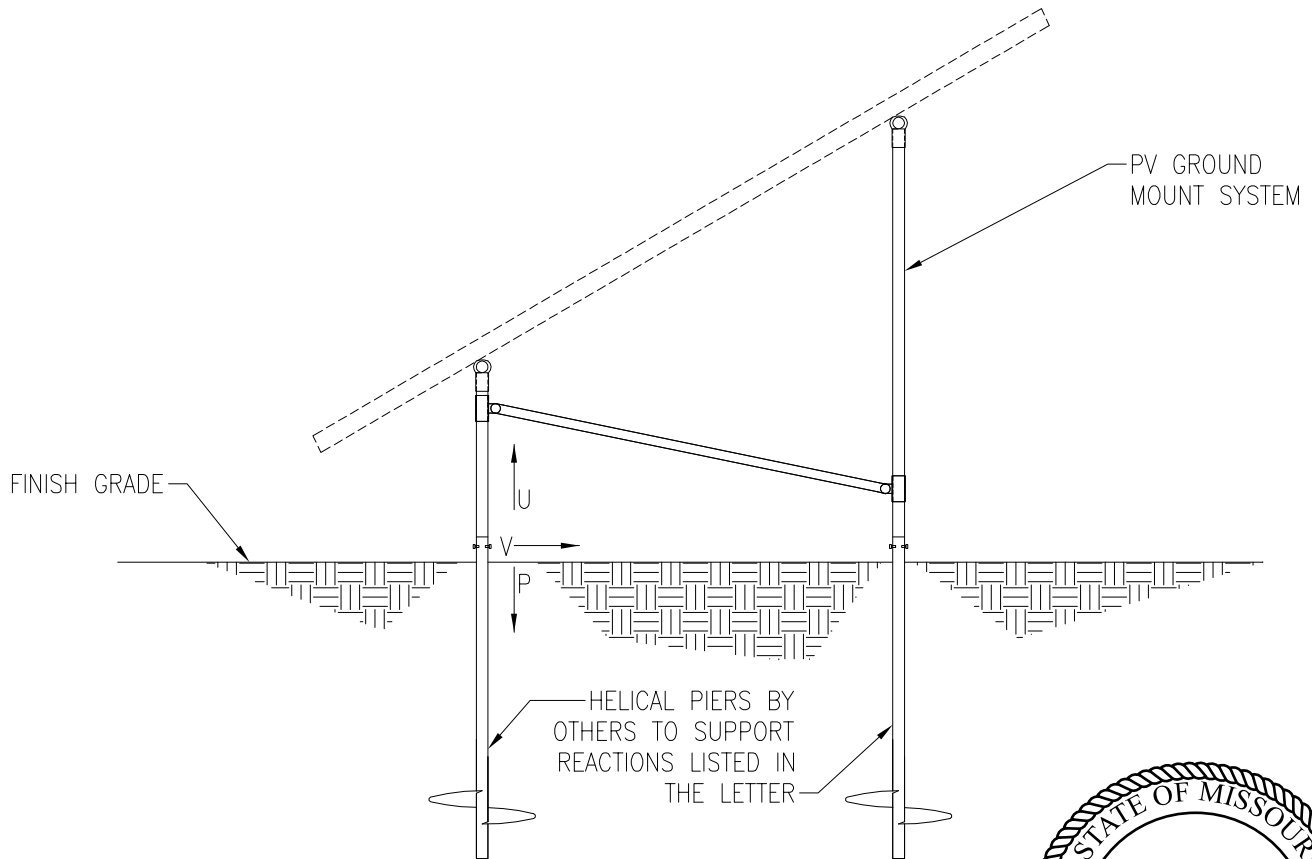

Vector Structural Engineering requires that we review each site-specific install, and we are not liable for installs at site-specific locations we have not reviewed. This document does not address site-specific installations.



PV ARRAY SECTION

04/24/2024

N.T.S.

(S2)

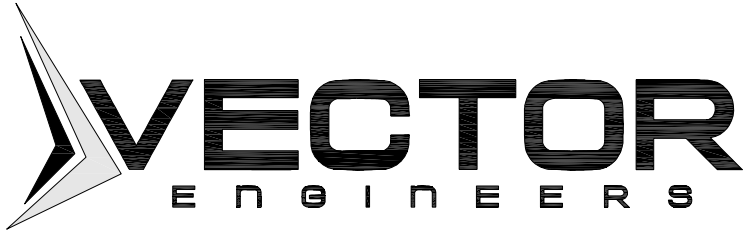

JOB NO. U2716-0366-231

PROJECT SUNMODO SUNTURF GROUND MOUNTS B7

SUBJECT GROUND SCREW OPTION

NOTES:

1. For ground mount components see Section S1.
2. A minimum of (1) installed ground screw must be tested as follows:
 - 2.1. Safety factor for uplift to be 1.5
 - 2.2. S.F. for lateral loads to be 2.0
 - 2.3. Upward deflection limit = 1/2"
 - 2.4. Lateral deflection limit = 1"
 - 2.5. The load tests must be performed by an approved contractor

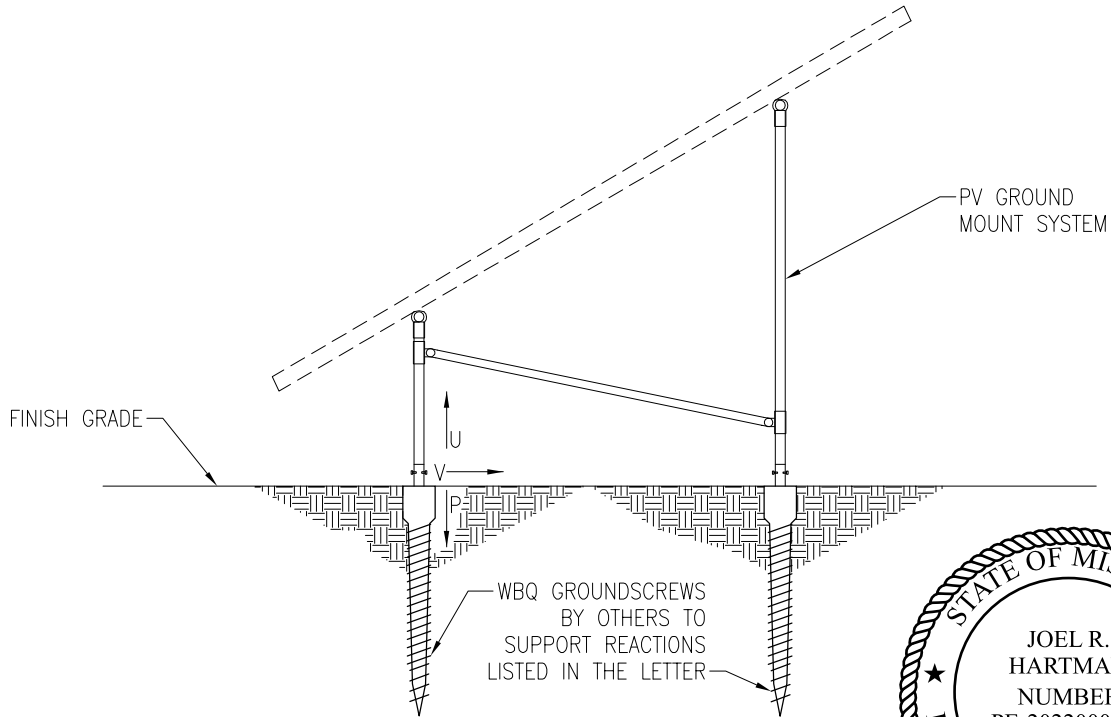

Vector Structural Engineering requires that we review each site-specific install, and we are not liable for installs at site-specific locations we have not reviewed. This document does not address site-specific installations.



PV ARRAY SECTION 04/24/2024
 N.T.S. S3

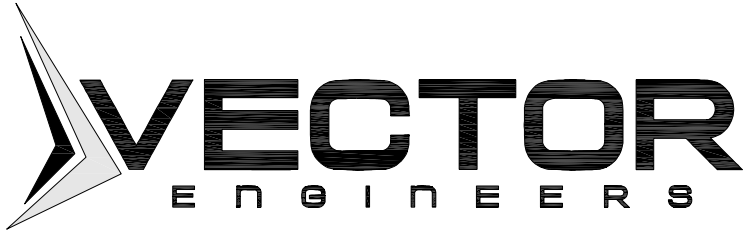

JOB NO. U2716-0366-231

PROJECT SUNMODO SUNTURF GROUND MOUNTS B6

SUBJECT BALLASTED BLOCK OPTION

NOTES:

- For ground mount components see Section S1.



04/24/2024

Vector Structural Engineering requires that we review each site-specific install, and we are not liable for installs at site-specific locations we have not reviewed. This document does not address site-specific installations.

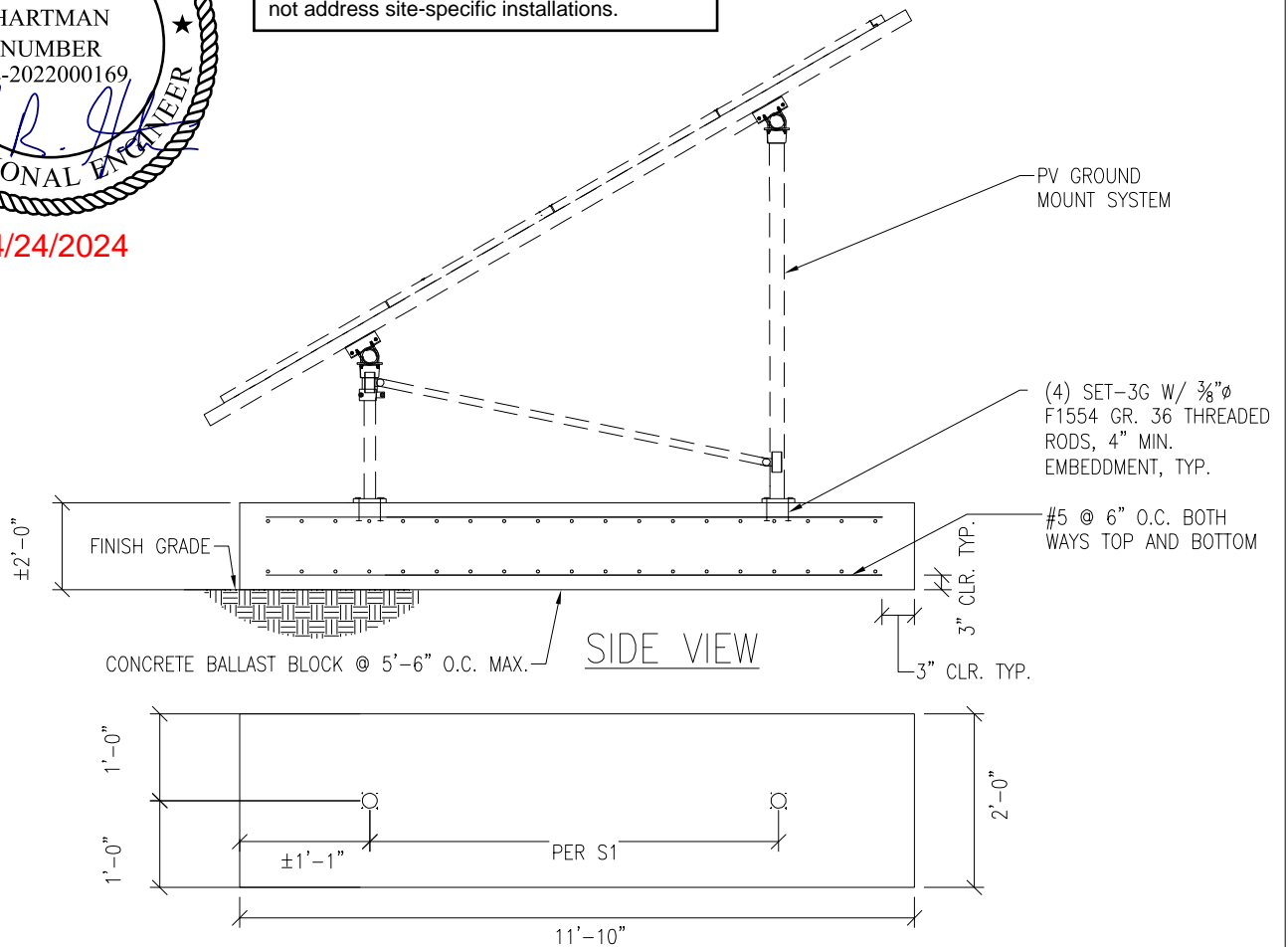

PV ARRAY SECTION

N.T.S.

S4



JOB NO.: U2716.0366.231
SUBJECT: SNOW LOADS

PROJECT: Sunturf Package B7

SNOW LOADS

Calculations Per:	ASCE 7-16	
Snow Ground Load, p_g [psf]:	50.0	(Section 7.2)
Risk Category:	I	(Table 1.5-1)
Importance Factor, I_s :	0.8	(Table 1.5-2)
Terrain Category:	C	(Section 26.7)
Exposure of Roof:	Fully Exposed	(Table 7-3.1)
Exposure Factor, C_e :	0.9	(Table 7-3.1)
Thermal Factor, C_t :	1.2	(Table 7-3.2)
Flat Roof Snow Load, p_f [psf]:	30	(Equation 7.3-1)
Min. Roof Snow Load, p_m [psf]:	0	(Section 7.3.4)
Panel Slope from Horizontal [°]:	30.0	
Unobstructed Slippery Surface?	Yes	(Section 7.4)
Slope Factor Figure:	Figure 7-2c	(of Figure 7.4-1 - See Section 7.4)
Roof Slope Factor, C_s :	0.73	
Sloped Roof Snow Load, p_s [psf]:	22	(Equation 7.4-1)
Design Snow Load, S [psf]:	22	(1.0 Snow)



JOB NO.: U2716.0366.231
SUBJECT: SNOW LOADS

PROJECT: Sunturf Package B7

SNOW LOADS

Calculations Per:	ASCE 7-16	
Snow Ground Load, p_g [psf]:	50.0	(Section 7.2)
Risk Category:	I	(Table 1.5-1)
Importance Factor, I_s :	0.8	(Table 1.5-2)
Terrain Category:	C	(Section 26.7)
Exposure of Roof:	Fully Exposed	(Table 7-3.1)
Exposure Factor, C_e :	0.9	(Table 7-3.1)
Thermal Factor, C_t :	1.2	(Table 7-3.2)
Flat Roof Snow Load, p_f [psf]:	30	(Equation 7.3-1)
Min. Roof Snow Load, p_m [psf]:	0	(Section 7.3.4)
Panel Slope from Horizontal [°]:	15.0	
Unobstructed Slippery Surface?	Yes	(Section 7.4)
Slope Factor Figure:	Figure 7-2c	(of Figure 7.4-1 - See Section 7.4)
Roof Slope Factor, C_s :	1.00	
Sloped Roof Snow Load, p_s [psf]:	30	(Equation 7.4-1)
Design Snow Load, S [psf]:	30	(1.0 Snow)



JOB NO.: U2716.0366.231
SUBJECT: SNOW LOADS

PROJECT: Sunturf Package B7

SNOW LOADS

Calculations Per:	ASCE 7-16	
Snow Ground Load, p_g [psf]:	50.0	(Section 7.2)
Risk Category:	I	(Table 1.5-1)
Importance Factor, I_s :	0.8	(Table 1.5-2)
Terrain Category:	C	(Section 26.7)
Exposure of Roof:	Fully Exposed	(Table 7-3.1)
Exposure Factor, C_e :	0.9	(Table 7-3.1)
Thermal Factor, C_t :	1.2	(Table 7-3.2)
Flat Roof Snow Load, p_f [psf]:	30	(Equation 7.3-1)
Min. Roof Snow Load, p_m [psf]:	16	(Section 7.3.4)
Panel Slope from Horizontal [°]:	5.0	
Unobstructed Slippery Surface?	Yes	(Section 7.4)
Slope Factor Figure:	Figure 7-2c	(of Figure 7.4-1 - See Section 7.4)
Roof Slope Factor, C_s :	1.00	
Sloped Roof Snow Load, p_s [psf]:	30	(Equation 7.4-1)
Design Snow Load, S [psf]:	30	(1.0 Snow)



PROJECT: Sunturf Package B7 Ground Mount

WIND PRESSURES

Calculations per:	ASCE 7-16	
Design Wind Speed, V [mph]:	105	
Risk Category:	I	(Table 1.5-1)
Exposure Category:	C	(Section 26.7)
Elevation [ft]:	2769.9	
Ground Elevation Factor, K_e :	0.90	(Table 26.9-1)
α :	9.5	(Table 26.11-1)
z_g [ft]:	900	(Table 26.11-1)
Velocity Pressure Exposure Coefficient, K_h :	0.85	(Table 26.10-1)
Topographic Factor, K_{ht} :	1.0	(Section 26.8)
Wind Directionality Factor, K_d :	0.85	(Table 26.6-1)
Internal Pressure Coefficient, GC_{pi} :	0.00	(Figure 26.13-1)
Velocity Pressure, q_h [psf]:	18.42	(Equation 26.10-1)
Gust Effect Factor, G:	0.85	(Section 26.11.4)
Panel Slope [degrees]:	30.0	
Wind Flow:	Clear	
Roof Configuration:	Monoslope	

Wind Pressures in Transverse (N-S) Direction

Net Pressure Coefficients per Figure 27.3-4

Clear Wind Flow	C_{NW}	C_{NL}
Case 1 ($\gamma = 0^\circ$, Load Case A)	-1.8	-1.8
Case 2 ($\gamma = 0^\circ$, Load Case B)	-2.5	-0.5
Case 3 ($\gamma = 180^\circ$, Load Case A)	2.1	2.1
Case 4 ($\gamma = 180^\circ$, Load Case B)	2.6	1.0

Design Wind Pressures per Equation 27.3-2 [psf]

Clear Wind Flow	$q_h GC_{NW}$	$q_h GC_{NL}$
Case 1 ($\gamma = 0^\circ$, Load Case A)	-28.2	-28.2
Case 2 ($\gamma = 0^\circ$, Load Case B)	-39.1	-7.8
Case 3 ($\gamma = 180^\circ$, Load Case A)	32.9	32.9
Case 4 ($\gamma = 180^\circ$, Load Case B)	40.7	15.7
Case 5 ($\gamma = 0^\circ$, 16 psf Min. Horiz.)	-16.0	-16.0
Case 6 ($\gamma = 180^\circ$, 16 psf Min. Horiz)	16.0	16.0



PROJECT: Sunturf Package B7 Ground Mount

WIND PRESSURES

Calculations per:	ASCE 7-16	
Design Wind Speed, V [mph]:	105	
Risk Category:	I	(Table 1.5-1)
Exposure Category:	C	(Section 26.7)
Elevation [ft]:	2769.9	
Ground Elevation Factor, K_e :	0.90	(Table 26.9-1)
α :	9.5	(Table 26.11-1)
z_g [ft]:	900	(Table 26.11-1)
Velocity Pressure Exposure Coefficient, K_h :	0.85	(Table 26.10-1)
Topographic Factor, K_{ht} :	1.0	(Section 26.8)
Wind Directionality Factor, K_d :	0.85	(Table 26.6-1)
Internal Pressure Coefficient, GC_{pi} :	0.00	(Figure 26.13-1)
Velocity Pressure, q_h [psf]:	18.42	(Equation 26.10-1)
Gust Effect Factor, G:	0.85	(Section 26.11.4)
Panel Slope [degrees]:	15.0	
Wind Flow:	Clear	
Roof Configuration:	Monoslope	

Wind Pressures in Transverse (N-S) Direction

Net Pressure Coefficients per Figure 27.3-4

Clear Wind Flow	C_{NW}	C_{NL}
Case 1 ($\gamma = 0^\circ$, Load Case A)	-0.9	-1.3
Case 2 ($\gamma = 0^\circ$, Load Case B)	-1.9	0.0
Case 3 ($\gamma = 180^\circ$, Load Case A)	1.3	1.6
Case 4 ($\gamma = 180^\circ$, Load Case B)	1.8	0.6

Design Wind Pressures per Equation 27.3-2 [psf]

Clear Wind Flow	$q_h GC_{NW}$	$q_h GC_{NL}$
Case 1 ($\gamma = 0^\circ$, Load Case A)	-14.1	-20.4
Case 2 ($\gamma = 0^\circ$, Load Case B)	-29.8	0.0
Case 3 ($\gamma = 180^\circ$, Load Case A)	20.4	25.1
Case 4 ($\gamma = 180^\circ$, Load Case B)	28.2	9.4
Case 5 ($\gamma = 0^\circ$, 16 psf Min. Horiz.)	-16.0	-16.0
Case 6 ($\gamma = 180^\circ$, 16 psf Min. Horiz)	16.0	16.0



PROJECT: Sunturf Package B7 Ground Mount

WIND PRESSURES

Calculations per:	ASCE 7-16	
Design Wind Speed, V [mph]:	105	
Risk Category:	I	(Table 1.5-1)
Exposure Category:	C	(Section 26.7)
Elevation [ft]:	2769.9	
Ground Elevation Factor, K_e :	0.90	(Table 26.9-1)
α :	9.5	(Table 26.11-1)
z_g [ft]:	900	(Table 26.11-1)
Velocity Pressure Exposure Coefficient, K_h :	0.85	(Table 26.10-1)
Topographic Factor, K_{ht} :	1.0	(Section 26.8)
Wind Directionality Factor, K_d :	0.85	(Table 26.6-1)
Internal Pressure Coefficient, GC_{pi} :	0.00	(Figure 26.13-1)
Velocity Pressure, q_h [psf]:	18.42	(Equation 26.10-1)
Gust Effect Factor, G:	0.85	(Section 26.11.4)
Panel Slope [degrees]:	5.0	
Wind Flow:	Clear	
Roof Configuration:	Monoslope	

Wind Pressures in Transverse (N-S) Direction

Net Pressure Coefficients per Figure 27.3-4

Clear Wind Flow	C_{NW}	C_{NL}
Case 1 ($\gamma = 0^\circ$, Load Case A)	1.2	0.3
Case 2 ($\gamma = 0^\circ$, Load Case B)	-1.1	-0.1
Case 3 ($\gamma = 180^\circ$, Load Case A)	1.2	0.3
Case 4 ($\gamma = 180^\circ$, Load Case B)	-1.1	-0.1

Design Wind Pressures per Equation 27.3-2 [psf]

Clear Wind Flow	$q_h GC_{NW}$	$q_h GC_{NL}$
Case 1 ($\gamma = 0^\circ$, Load Case A)	18.8	4.7
Case 2 ($\gamma = 0^\circ$, Load Case B)	-17.2	-1.6
Case 3 ($\gamma = 180^\circ$, Load Case A)	18.8	4.7
Case 4 ($\gamma = 180^\circ$, Load Case B)	-17.2	-1.6
Case 5 ($\gamma = 0^\circ$, 16 psf Min. Horiz.)	-16.0	-16.0
Case 6 ($\gamma = 180^\circ$, 16 psf Min. Horiz)	16.0	16.0

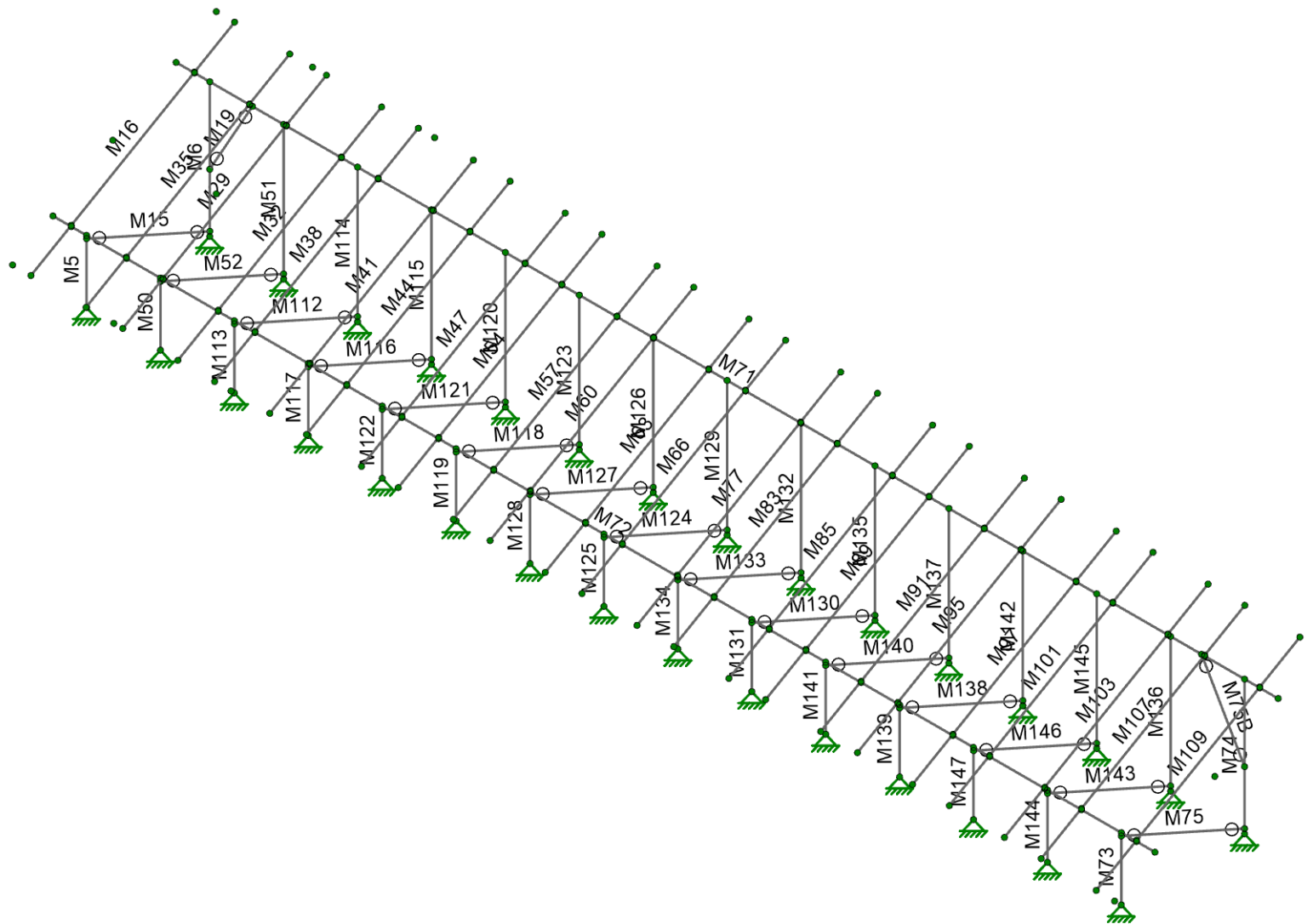
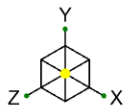

Vector Structural Engineering

LKN

U2716.0366.231

Sunturf Ground Mount B7 SF

30°

SK-1

Feb 02, 2023

Sunturf Ground Mount B7 82x42 30deg.r3d

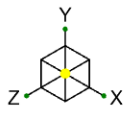

Section Sets

- █ Post
- █ Cross Beam
- █ Diagonal Brace
- █ RIGID
- █ AL Rails

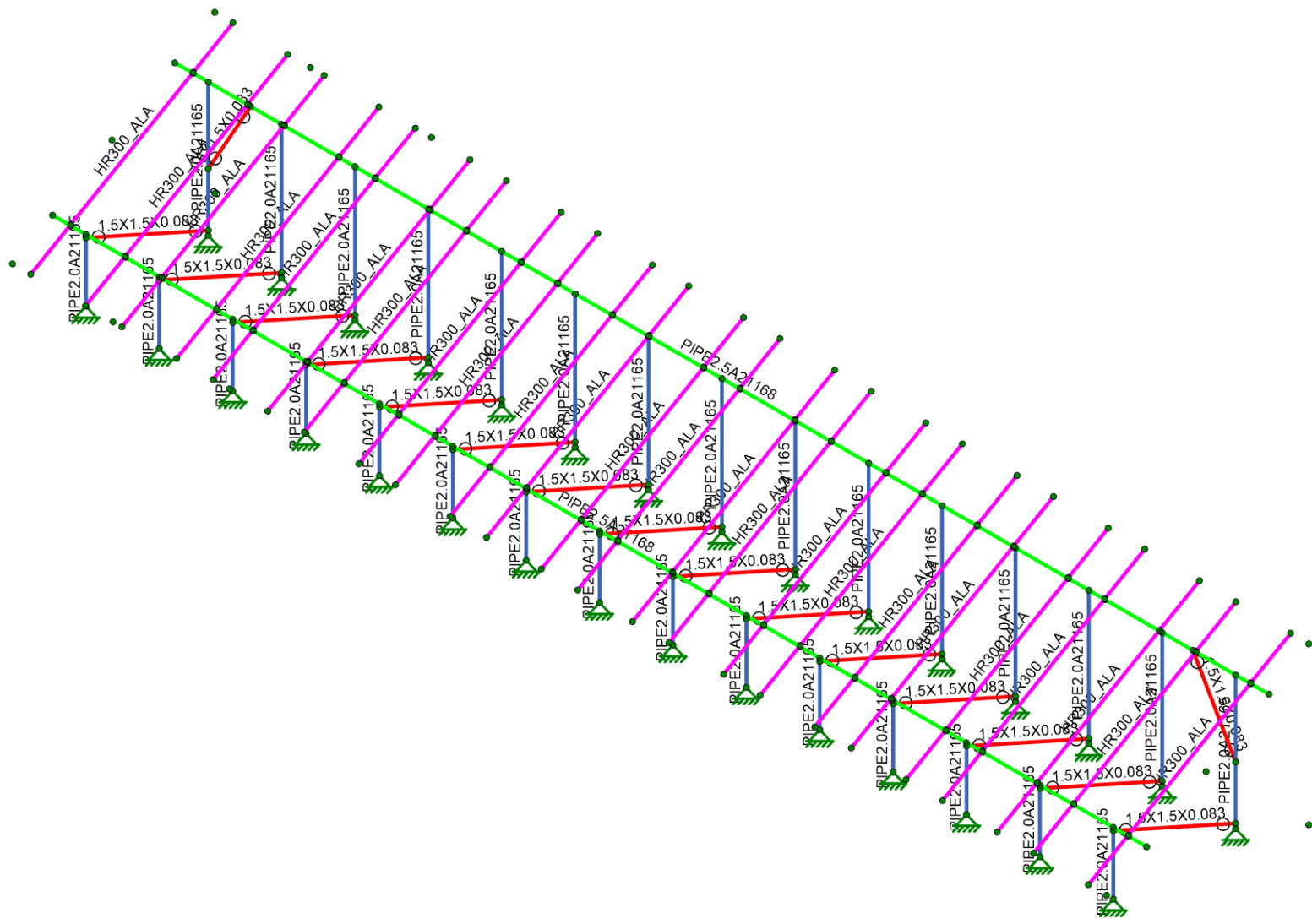

Vector Structural Engineering
 LKN
 U2716.0366.231

Sunturf Ground Mount B7 SF
 30°

SK-2
 Feb 02, 2023
 Sunturf Ground Mount B7 82x42 30deg.r3d

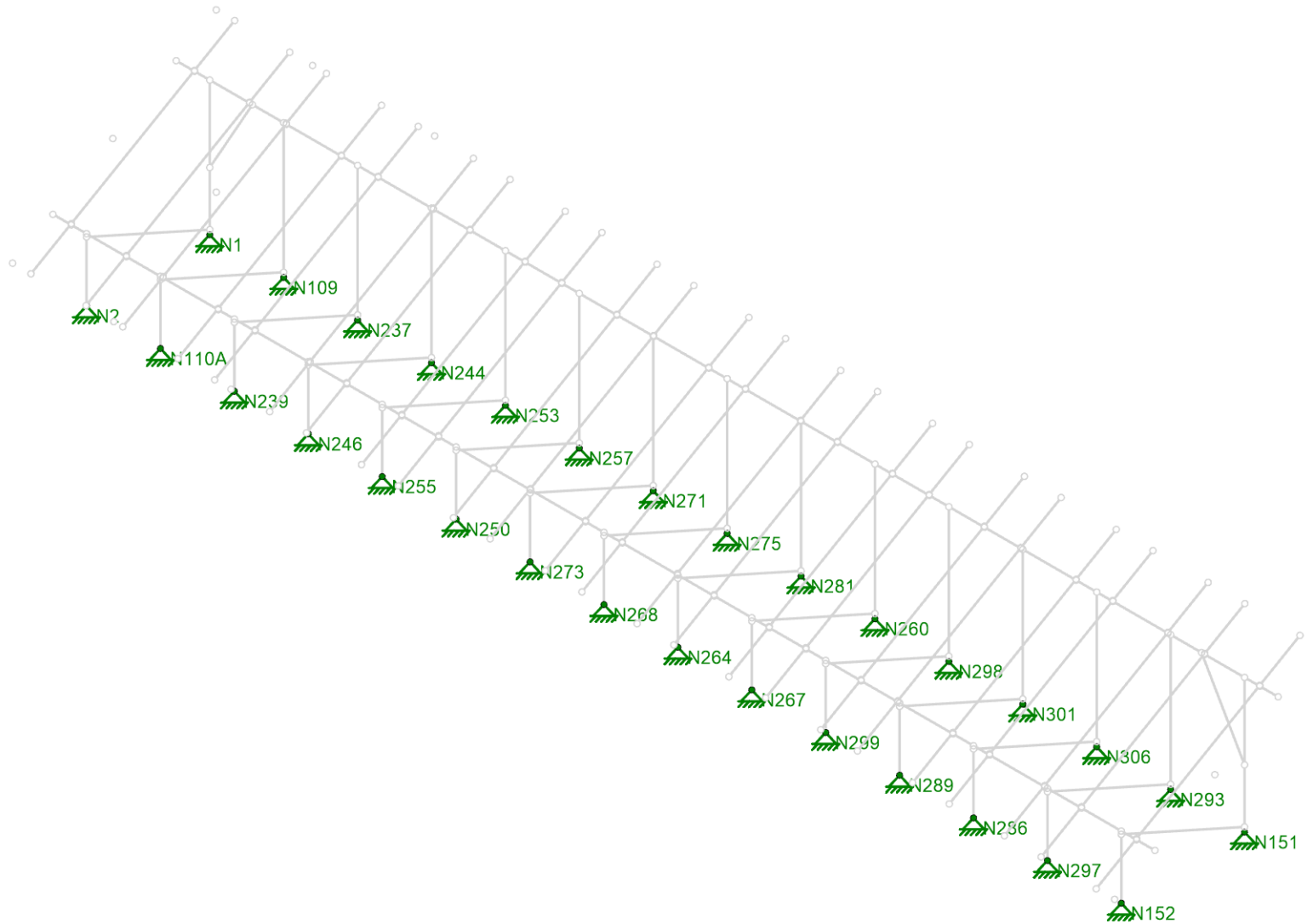
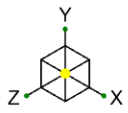

Vector Structural Engineering

LKN

U2716.0366.231

Sunturf Ground Mount B7 SF

30°

SK-3

Feb 02, 2023

Sunturf Ground Mount B7 82x42 30deg.r3d

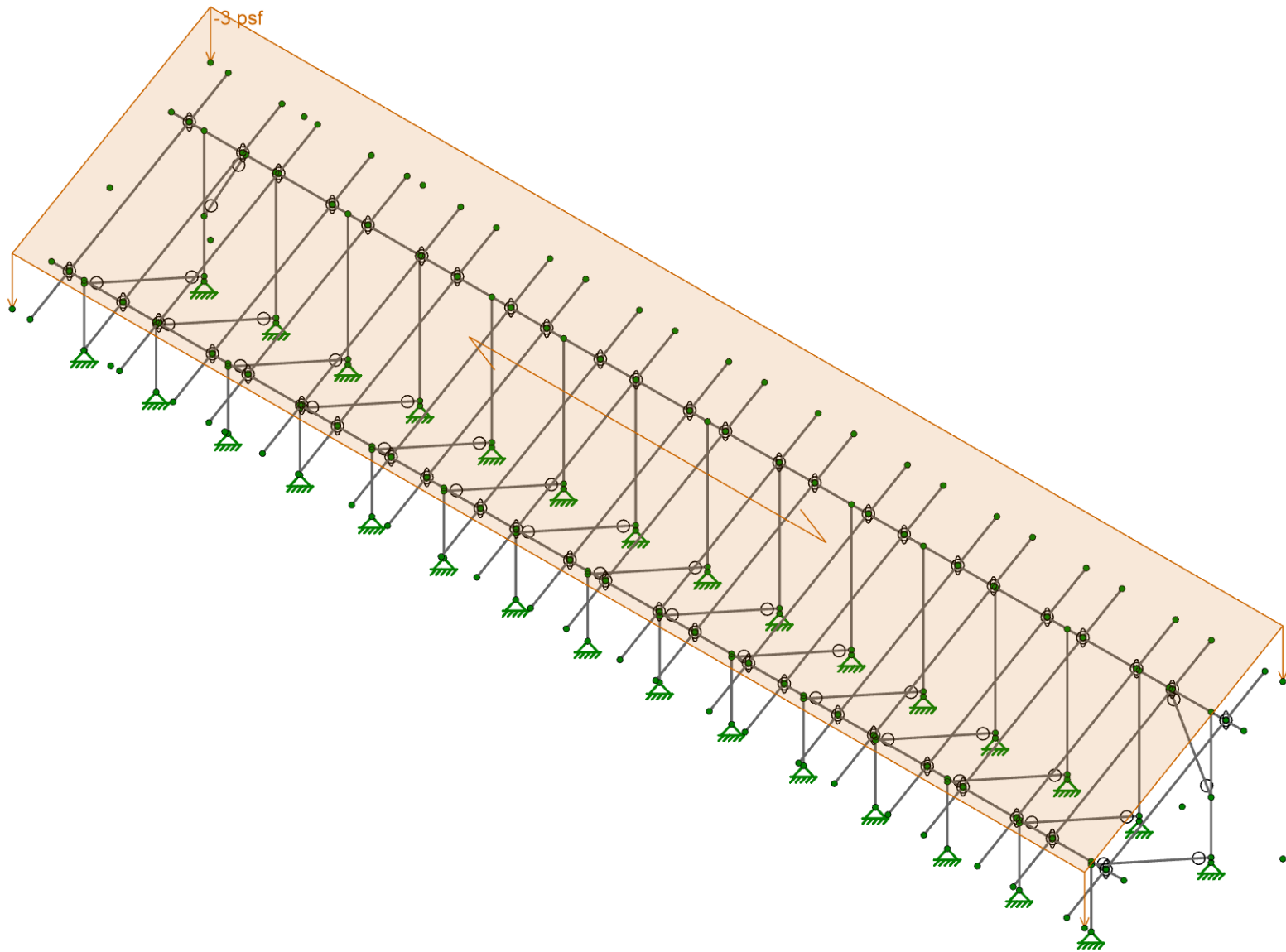
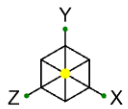

Loads: BLC 2, Solar Panel Weight

Vector Structural Engineering
LKN
U2716.0366.231

Sunturf Ground Mount B7 SF
30°

SK-4
Feb 02, 2023
Sunturf Ground Mount B7 82x42 30deg.r3d

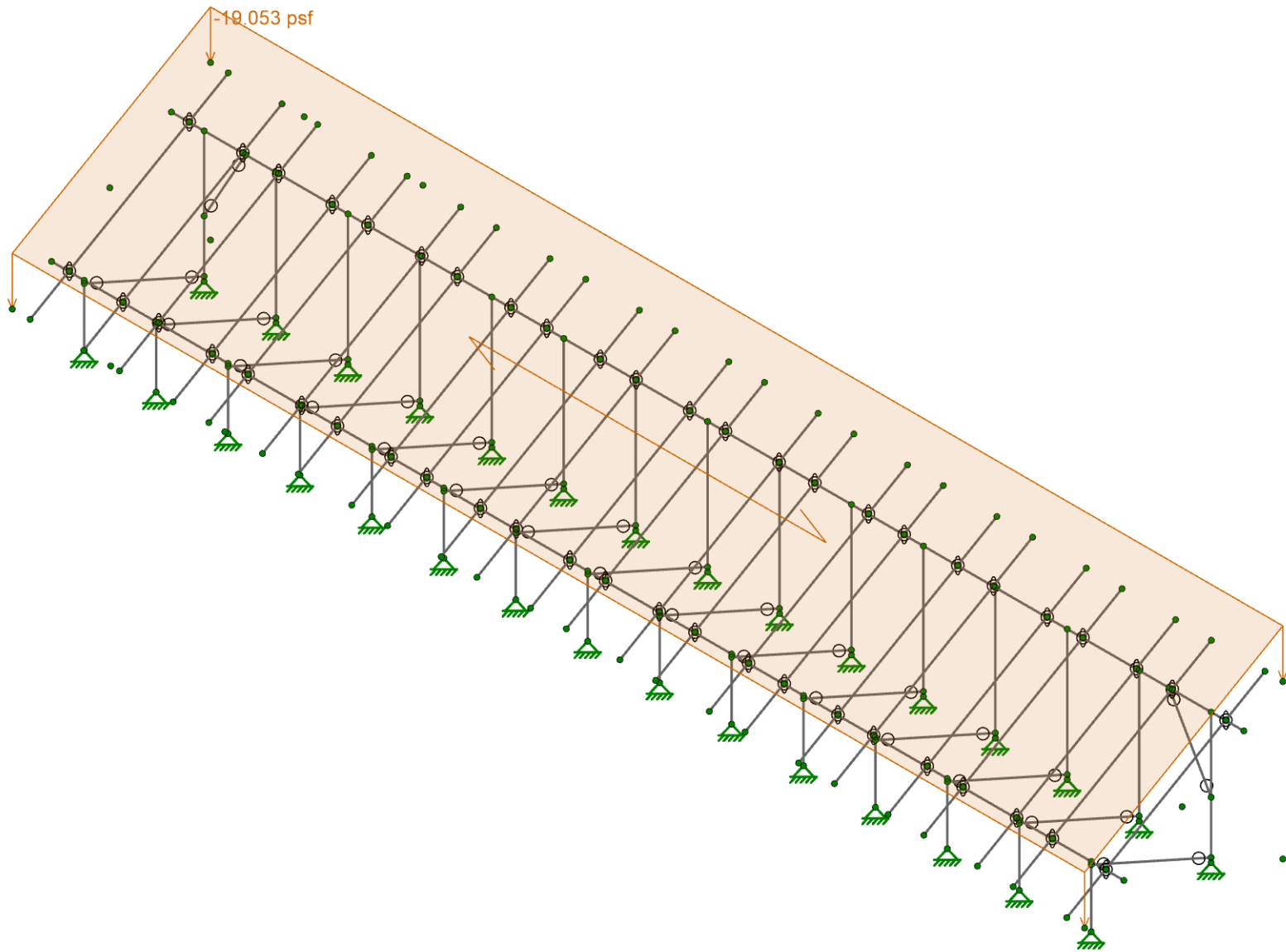
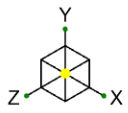

Loads: BLC 3, Roof Live/Snow

Vector Structural Engineering
LKN
U2716.0366.231

Sunturf Ground Mount B7 SF
30°

SK-5
Feb 02, 2023
Sunturf Ground Mount B7 82x42 30deg.r3d

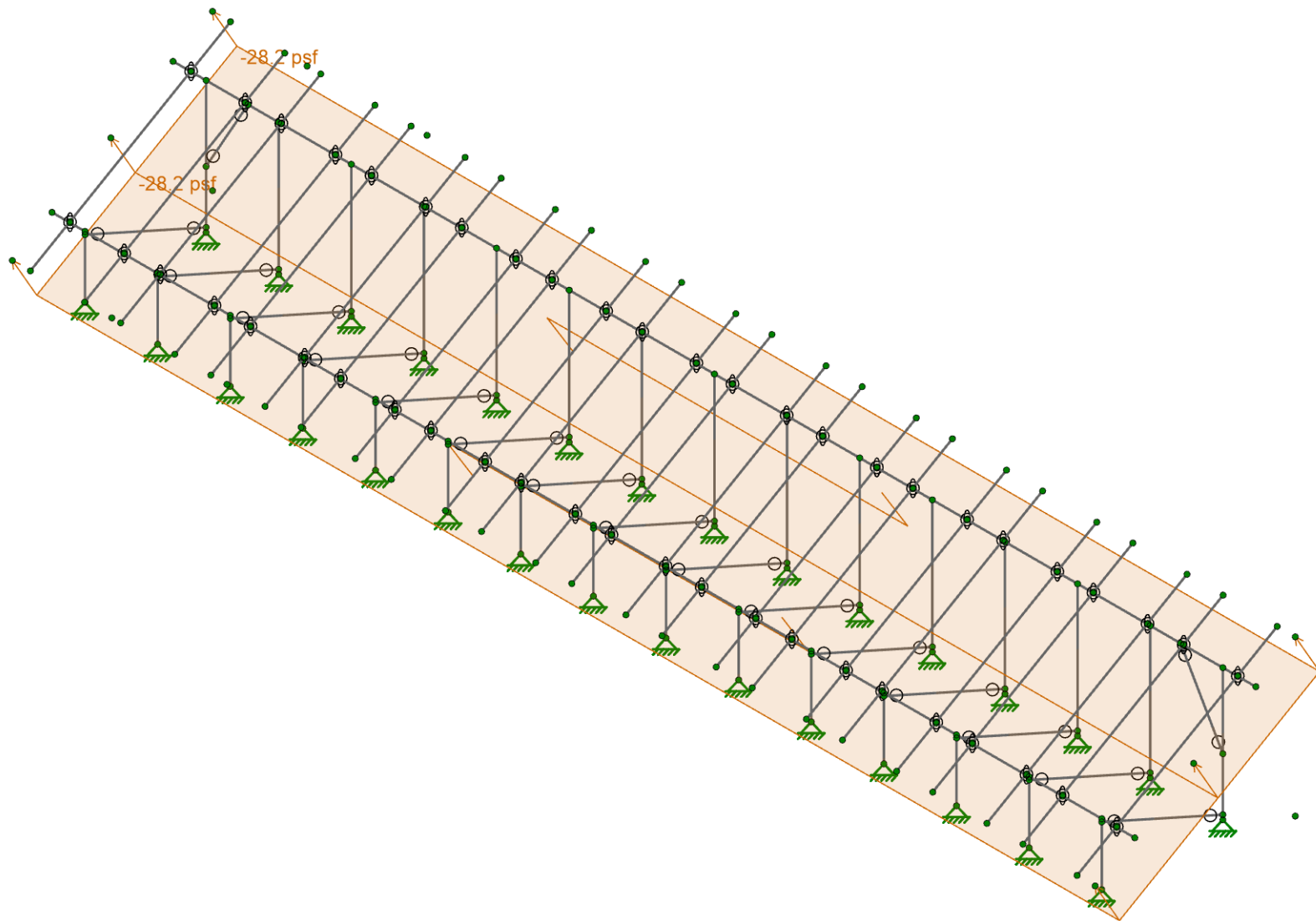
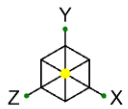

Loads: BLC 4, Wind A 0 deg

Vector Structural Engineering
LKN
U2716.0366.231

Sunturf Ground Mount B7 SF
30°

SK-6
Feb 02, 2023
Sunturf Ground Mount B7 82x42 30deg.r3d

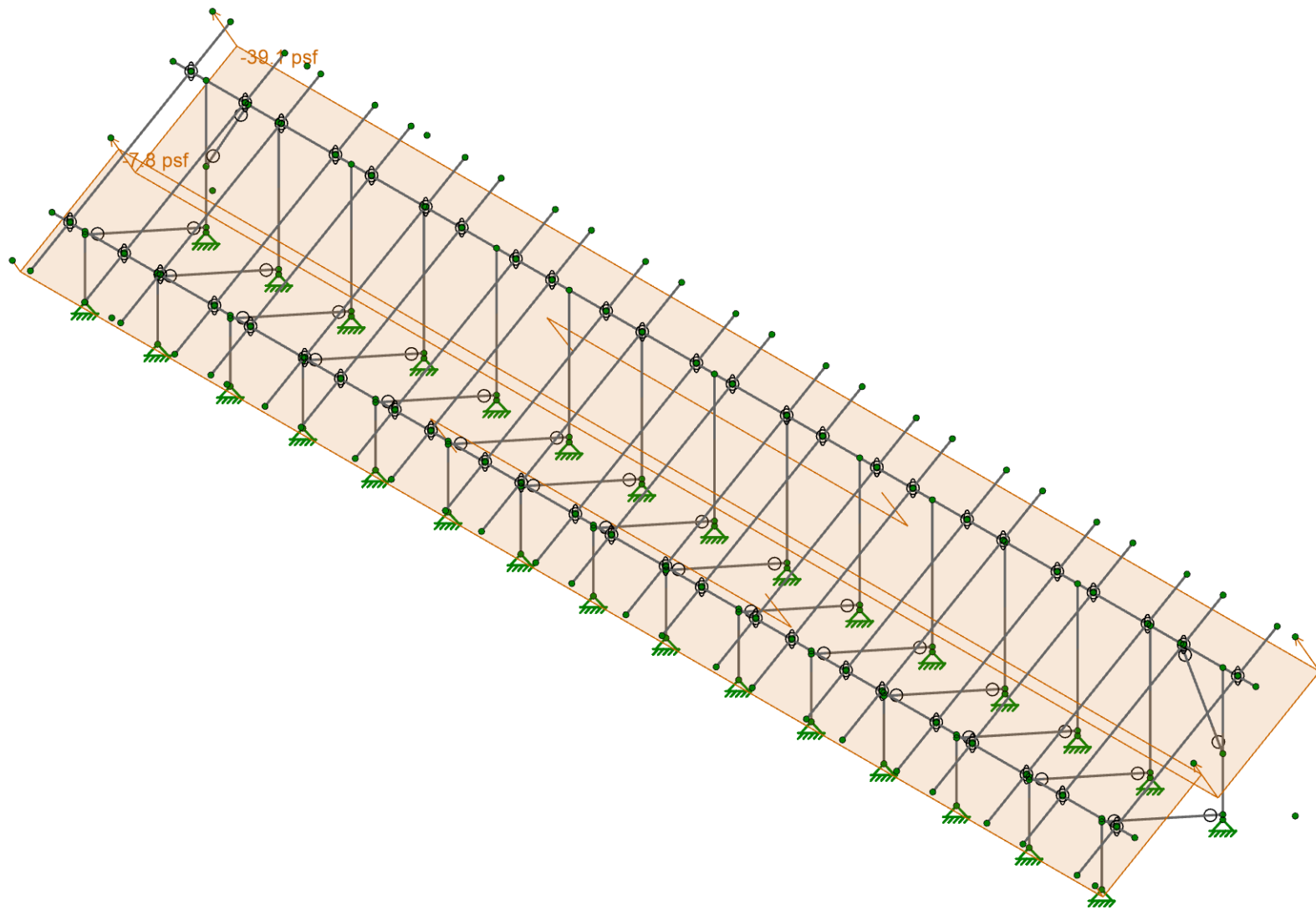
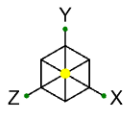

Loads: BLC 5, Wind B 0 deg

Vector Structural Engineering
LKN
U2716.0366.231

Sunturf Ground Mount B7 SF
30°

SK-7
Feb 02, 2023
Sunturf Ground Mount B7 82x42 30deg.r3d

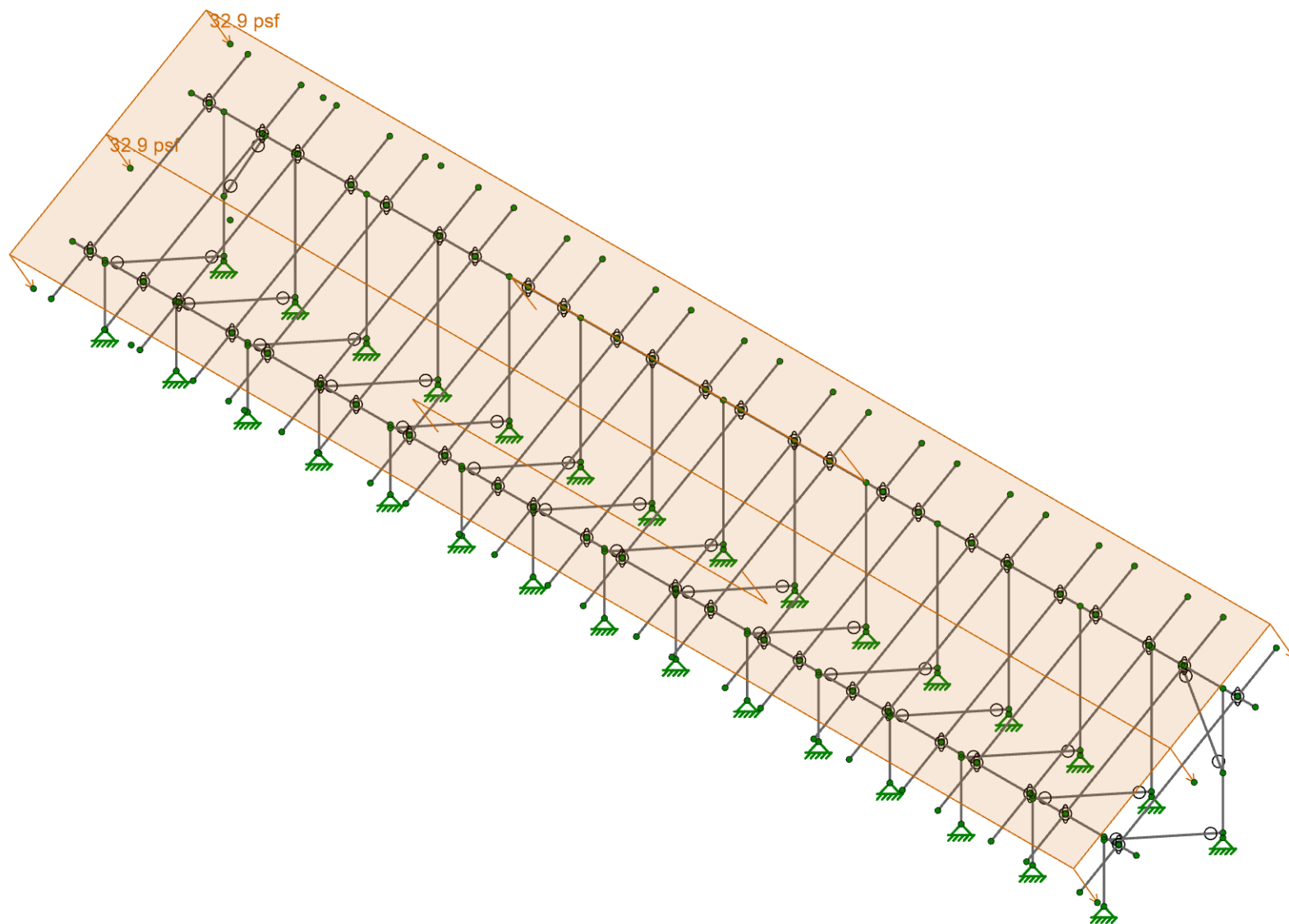
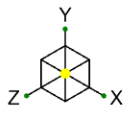

Loads: BLC 6, Wind A 180 deg

Vector Structural Engineering
LKN
U2716.0366.231

Sunturf Ground Mount B7 SF
30°

SK-8
Feb 02, 2023
Sunturf Ground Mount B7 82x42 30deg.r3d

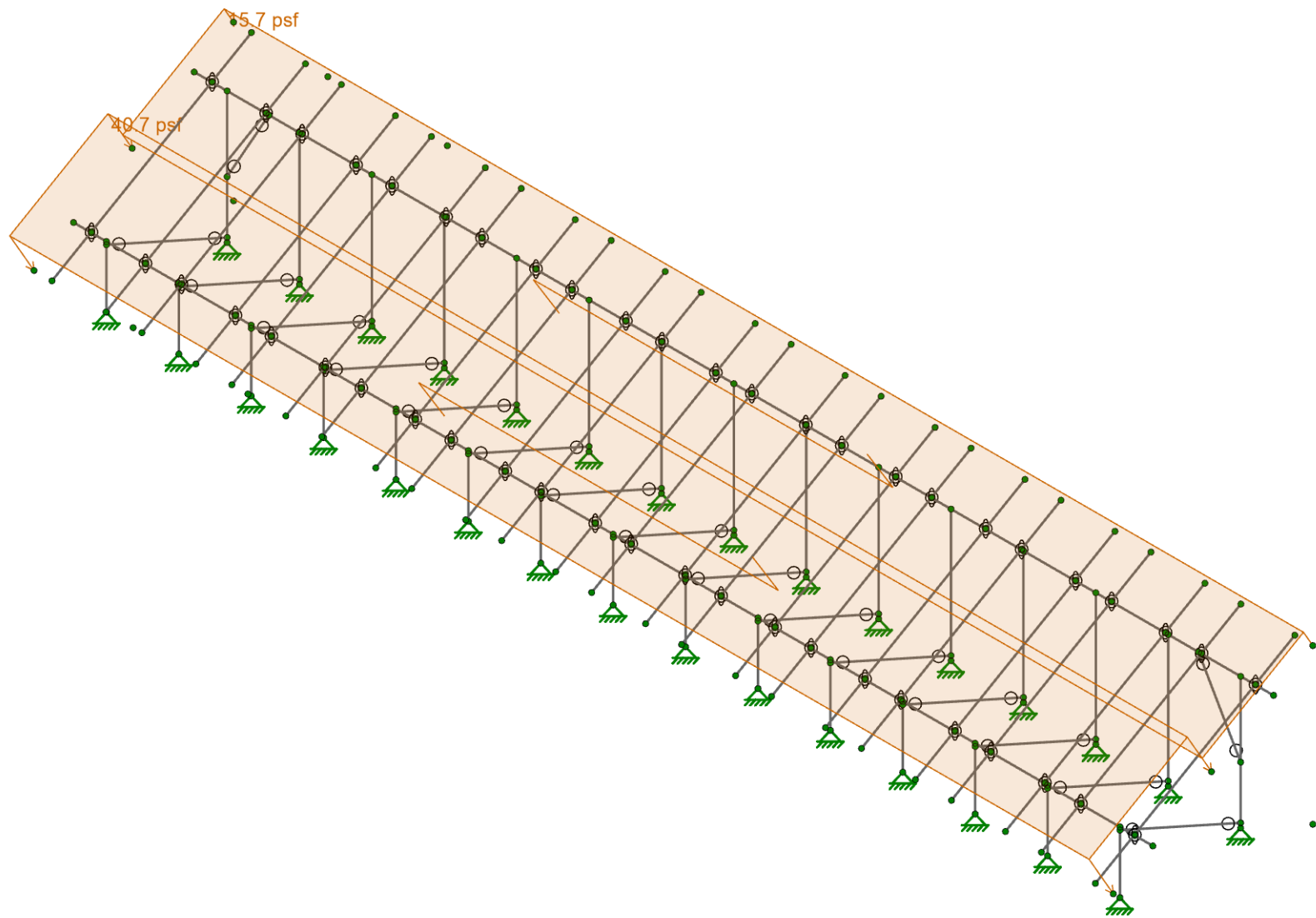
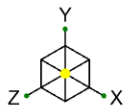

Loads: BLC 7, Wind B 180 deg

Vector Structural Engineering
LKN
U2716.0366.231

Sunturf Ground Mount B7 SF
30°

SK-9
Feb 02, 2023
Sunturf Ground Mount B7 82x42 30deg.r3d

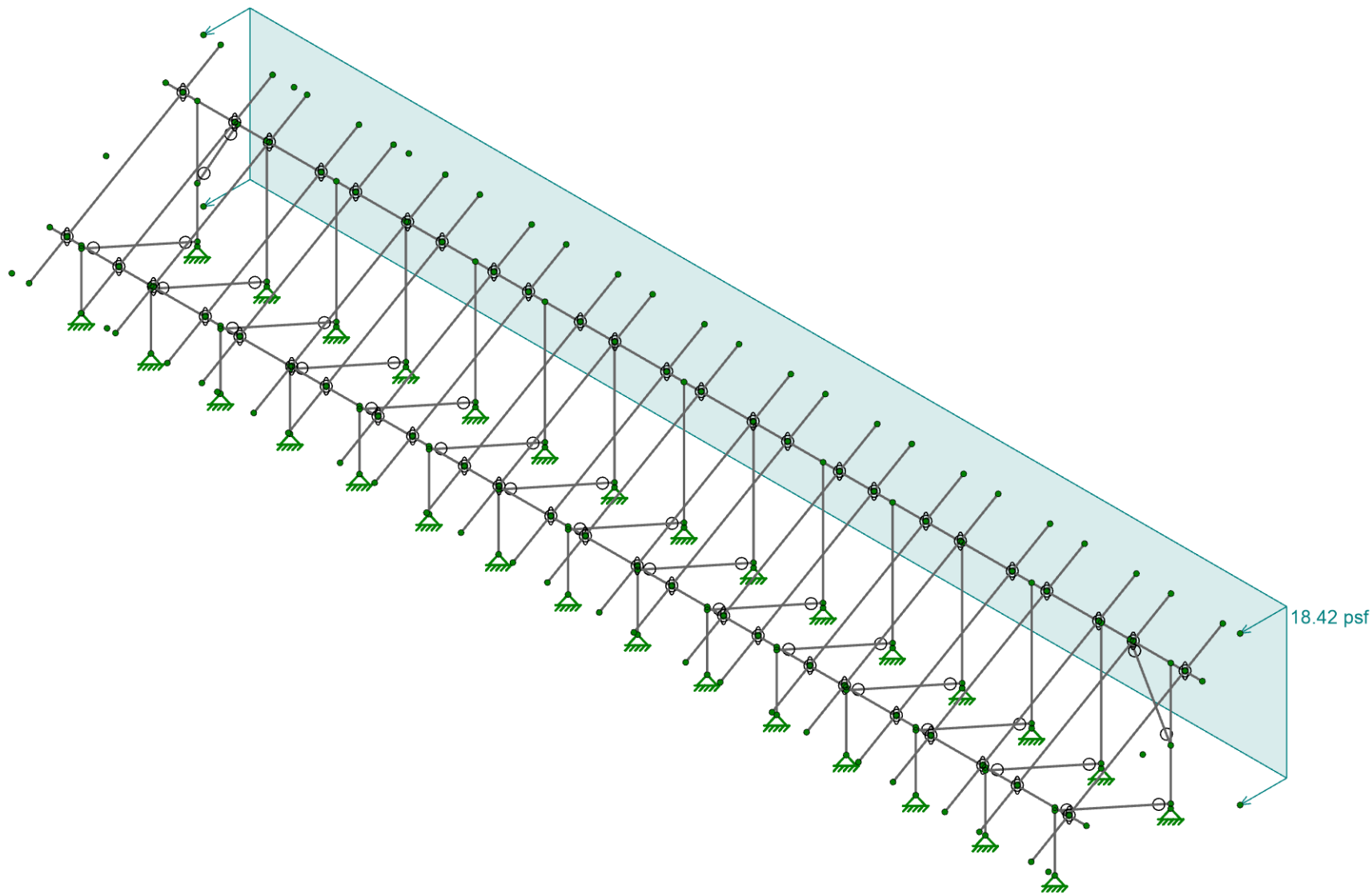
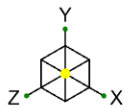

Loads: BLC 8, Wind Z

Vector Structural Engineering
LKN
U2716.0366.231

Sunturf Ground Mount B7 SF
30°

SK-10
Feb 02, 2023
Sunturf Ground Mount B7 82x42 30deg.r3d

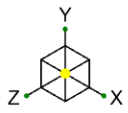

Code Check (Env)

- No Calc
- > 1.0
- .90-1.0
- .75-.90
- .50-.75
- 0-.50

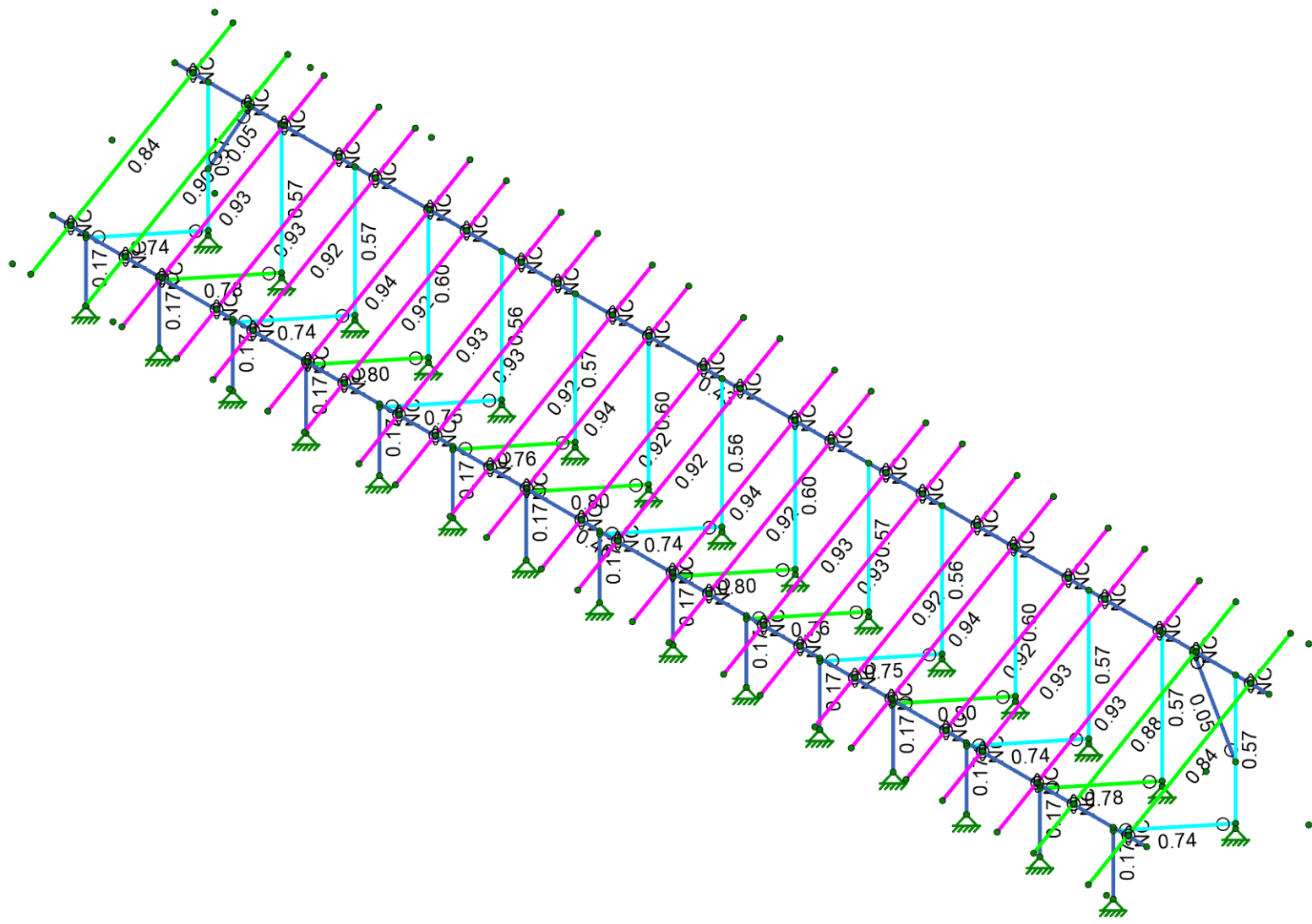

Member Code Checks Displayed (Enveloped)		
Vector Structural Engineering	Sunturf Ground Mount B7 SF	SK-11
LKN	30°	Feb 02, 2023
U2716.0366.231		Sunturf Ground Mount B7 82x42 30deg.r3d

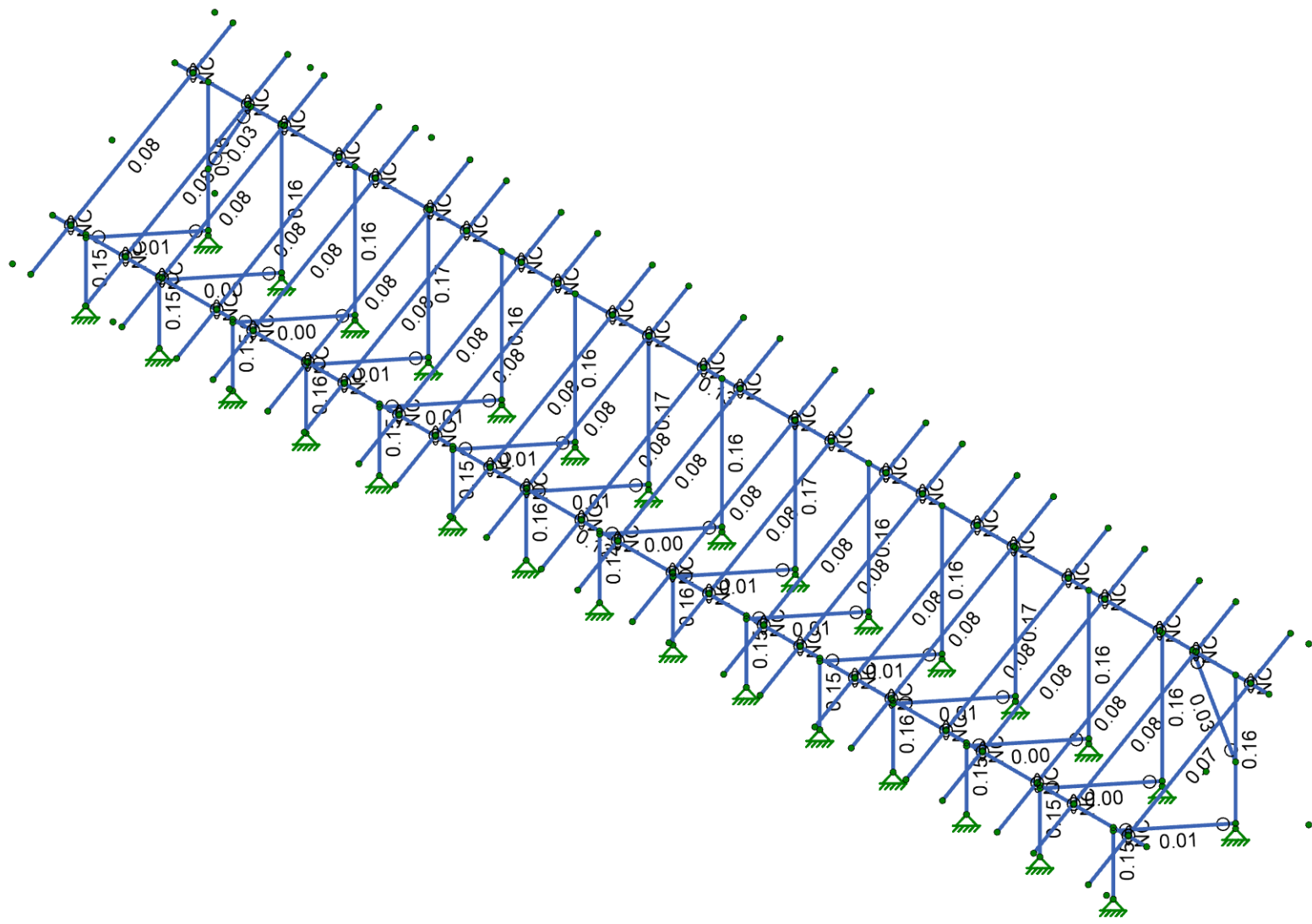
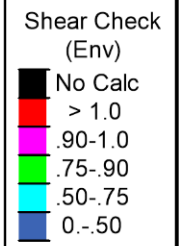
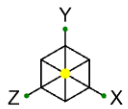

Member Shear Checks Displayed (Enveloped)		
Vector Structural Engineering	Sunturf Ground Mount B7 SF	SK-12
LKN	30°	Feb 02, 2023
U2716.0366.231		Sunturf Ground Mount B7 82x42 30deg.r3d

Model Settings

Number of Reported Sections	5
Number of Internal Sections	100
Member Area Load Mesh Size (in ²)	144
Consider Shear Deformation	Yes
Consider Torsional Warping	Yes
Approximate Mesh Size (in)	24
Transfer Forces Between Intersecting Wood Walls	Yes
Increase Wood Wall Nailing Capacity for Wind Loads	Yes
Include P-Delta for Walls	Yes
Optimize Masonry and Wood Walls	Yes
Maximum Number of Iterations	3
Single	No
Multiple (Optimum)	Yes
Maximum	No

Global Axis corresponding to vertical direction	Y
Convert Existing Data	Yes
Default Global Plane for z-axis	XZ
Plate Local Axis Orientation	Nodal

Hot Rolled Steel	AISC 15th (360-16): ASD
Stiffness Adjustment	Yes (Iterative)
Notional Annex	None
Connections	None
Cold Formed Steel	None
Stiffness Adjustment	Yes (Iterative)
Wood	None
Temperature	< 100F
Concrete	ACI 318-14
Masonry	None
Aluminum	AA ADM1-15: ASD
Structure Type	Building
Stiffness Adjustment	Yes (Iterative)
Stainless	None
Stiffness Adjustment	Yes (Iterative)

Analysis Methodology	Exact Integration Method
Parame Beta Factor	0.65

Compression Stress Block	Rectangular Stress Block
Analyze using Cracked Sections	No
Leave room for horizontal rebar splices (2*d bar spacing)	Yes
List forces which were ignored for design in the Detail Report	Yes

Column Min Steel	1
Column Max Steel	8
Rebar Material Spec	ASTM A615
Warn if beam-column framing arrangement is not understood	No
Number of Shear Regions	4
Region 2 & 3 Spacing Increase Increment (in)	3.999992

Code	None
------	------



Company : Vector Structural Engineering
Designer : LKN
Job Number : U2716.0366.231
Model Name : Sunturf Ground Mount B7 SF

2/7/2023
11:56:16 AM
Checked By : _____

Model Settings (Continued)

Base Elevation (ft)	15600
Include the weight of the structure in base shear calcs	Yes
T Z (sec)	
T X (sec)	
CZ	0.02
CX	0.02
R Z	3
R X	3

Hot Rolled Steel Properties

	Label	E [ksi]	G [ksi]	Nu	Therm. Coeff. [1e ⁵ F ⁻¹]	Density [lb/ft ³]	Yield [psi]	Ry	Fu [psi]	Rt
1	A992	29000	11154	0.3	0.65	490	50000	1.1	65000	1.1
2	A36 Gr.36	29000	11154	0.3	0.65	490	36000	1.5	58000	1.2
3	A572 Gr.50	29000	11154	0.3	0.65	490	50000	1.1	65000	1.1
4	A500 Gr.B RND	29000	11154	0.3	0.65	527	42000	1.4	58000	1.3
5	A500 Gr.B Rect	29000	11154	0.3	0.65	527	46000	1.4	58000	1.3
6	A53 Gr.B	29000	11154	0.3	0.65	490	35000	1.6	60000	1.2
7	A1085	29000	11154	0.3	0.65	490	50000	1.4	65000	1.3

Aluminum Properties

	Label	E [ksi]	G [ksi]	Nu	Therm. Coeff. [1e ⁵ F ⁻¹]	Density [lb/ft ³]	Table B.4	kt	Ftu [psi]	Fty [psi]	Fcy [psi]	Fsu [psi]	Ct
1	3003-H14	10100	3787.5	0.33	1.3	172.8	Table B.4-1	1	19000	16000	13000	12000	141
2	6061-T6	10100	3787.5	0.33	1.3	172.8	Table B.4-2	1	38000	35000	35000	24000	141
3	6063-T5	10100	3787.5	0.33	1.3	172.8	Table B.4-2	1	22000	16000	16000	13000	141
4	6063-T6	10100	3787.5	0.33	1.3	172.8	Table B.4-2	1	30000	25000	25000	19000	141
5	5052-H34	10200	3787.5	0.33	1.3	172.8	Table B.4-1	1	34000	26000	24000	20000	141
6	6061-T6 W	10100	3787.5	0.33	1.3	172.8	Table B.4-1	1	24000	15000	15000	15000	141
7	6005-T5	10100	3787.5	0.33	1.3	172.8	Table B.4-1	1	38000	35000	35000	24000	141

Hot Rolled Steel Section Sets

	Label	Shape	Type	Design List	Material	Design Rule	Area [in ²]	Iyy [in ⁴]	Izz [in ⁴]	J [in ⁴]
1	Post	PIPE2.0A21165	Column	Pipe	A572 Gr.50	Typical	0.776	0.499	0.499	0.998
2	Cross Beam	PIPE2.5A21168	Beam	Wide Flange	A572 Gr.50	Typical	0.947	0.907	0.907	1.814
3	Diagonal Brace	1.5X1.5X0.083	HBrace	SquareTube	A572 Gr.50	Typical	0.47	0.158	0.158	0.236

Aluminum Section Sets

	Label	Shape	Type	Design List	Material	Design Rule	Area [in ²]	Iyy [in ⁴]	Izz [in ⁴]	J [in ⁴]
1	AL Posts	2.375ODX0.188	Column	Pipe	6005-T5	Typical	1.29	0.778	0.778	1.54
2	AL Brace	RT1.5X2X0.15625	VBrace	Rectangular Tubes	6005-T5	Typical	0.996	0.327	0.524	0.602
3	AL Rails	HR300 ALA	Beam	Rectangular Tubes	6005-T5	Typical	0.736	0.214	0.727	0.734
4	AL Cross Beam	CROSSRAIL	Beam	Rectangular Tubes	6005-T5	Typical	1.909	1.97	4.366	4.017

Basic Load Cases

	BLC Description	Category	Y Gravity	Distributed	Area(Member)
1	Self Weight	DL	-1.05		
2	Solar Panel Weight	DL			1
3	Roof Live/Snow	RLL			1
4	Wind A 0 deg	OL1			2
5	Wind B 0 deg	OL2			2
6	Wind A 180 deg	OL3			2
7	Wind B 180 deg	OL4			2
8	Wind Z	WLZ			1
9	BLC 2 Transient Area Loads	None		52	
10	BLC 3 Transient Area Loads	None		52	
11	BLC 4 Transient Area Loads	None		160	
12	BLC 5 Transient Area Loads	None		160	
13	BLC 6 Transient Area Loads	None		160	
14	BLC 7 Transient Area Loads	None		160	
15	BLC 8 Transient Area Loads	None		104	

Member Area Loads (BLC 2 : Solar Panel Weight)

	Node A	Node B	Node C	Node D	Direction	Load Direction	Magnitude [psf]
1	N197	N200	N199	N196	Y	A-B	-3

Member Area Loads (BLC 3 : Roof Live/Snow)

	Node A	Node B	Node C	Node D	Direction	Load Direction	Magnitude [psf]
1	N197	N200	N199	N196	PY	A-B	-22

Member Area Loads (BLC 4 : Wind A 0 deg)

	Node A	Node B	Node C	Node D	Direction	Load Direction	Magnitude [psf]
1	N197	N200	N201	N198	Perp	A-B	-28.2
2	N198	N201	N199	N196	Perp	A-B	-28.2

Member Area Loads (BLC 5 : Wind B 0 deg)

	Node A	Node B	Node C	Node D	Direction	Load Direction	Magnitude [psf]
1	N197	N200	N201	N198	Perp	A-B	-39.1
2	N198	N201	N199	N196	Perp	A-B	-7.8

Member Area Loads (BLC 6 : Wind A 180 deg)

	Node A	Node B	Node C	Node D	Direction	Load Direction	Magnitude [psf]
1	N197	N200	N201	N198	Perp	A-B	32.9
2	N198	N201	N199	N196	Perp	A-B	32.9

Member Area Loads (BLC 7 : Wind B 180 deg)

	Node A	Node B	Node C	Node D	Direction	Load Direction	Magnitude [psf]
1	N197	N200	N201	N198	Perp	A-B	15.7
2	N198	N201	N199	N196	Perp	A-B	40.7

Member Area Loads (BLC 8 : Wind Z)

	Node A	Node B	Node C	Node D	Direction	Load Direction	Magnitude [psf]
1	N200	N197	N307	N308	Z	Open Structure	18.42

Load Combinations

	Description	Solve	P-Delta	BLC	Factor	BLC	Factor	BLC	Factor	BLC	Factor
1	ASD Loads		Y								
2	1.0 D	Yes	Y	DL	1						
3	1.0 D + 1.0 S	Yes	Y	DL	1	RLL	1				
4	1.0 D + 0.6 W1	Yes	Y	DL	1	RLL		OL1	0.6	WLZ	0.6
5	1.0 D + 0.6 W2	Yes	Y	DL	1	RLL		OL2	0.6	WLZ	0.6
6	1.0 D + 0.6 W3	Yes	Y	DL	1	RLL		OL3	0.6	WLZ	-0.6
7	1.0 D + 0.6 W4	Yes	Y	DL	1	RLL		OL4	0.6	WLZ	-0.6
8	1.0 D + 0.45 W1 + 0.75 S	Yes	Y	DL	1	RLL	0.75	OL1	0.45	WLZ	0.45
9	1.0 D + 0.45 W2 + 0.75 S	Yes	Y	DL	1	RLL	0.75	OL2	0.45	WLZ	0.45
10	1.0 D + 0.45 W3 + 0.75 S	Yes	Y	DL	1	RLL	0.75	OL3	0.45	WLZ	-0.45
11	1.0 D + 0.45 W4 + 0.75 S	Yes	Y	DL	1	RLL	0.75	OL4	0.45	WLZ	-0.45
12	0.6 D + 0.6 W1	Yes	Y	DL	0.6	RLL		OL1	0.6	WLZ	0.6
13	0.6 D + 0.6 W2	Yes	Y	DL	0.6	RLL		OL2	0.6	WLZ	0.6

Load Combinations (Continued)

	Description	Solve	P-Delta	BLC	Factor	BLC	Factor	BLC	Factor	BLC	Factor
14	0.6 D + 0.6 W3	Yes	Y	DL	0.6	RLL		OL3	0.6	WLZ	-0.6
15	0.6 D + 0.6 W4	Yes	Y	DL	0.6	RLL		OL4	0.6	WLZ	-0.6
16			Y								
17	LRFD Loads		Y								
18	1.4 D		Y	DL	1.4	RLL					
19	1.2 D + 1.6 S + 0.5 W1		Y	DL	1.2	RLL	1.6	OL1	0.5		
20	1.2 D + 1.6 S + 0.5 W2		Y	DL	1.2	RLL	1.6	OL2	0.5		
21	1.2 D + 1.6 S + 0.5 W3		Y	DL	1.2	RLL	1.6	OL3	0.5		
22	1.2 D + 1.6 S + 0.5 W4		Y	DL	1.2	RLL	1.6	OL4	0.5		
23	1.2 D + 1.0 W1		Y	DL	1.2	RLL		OL1	1		
24	1.2 D + 1.0 W2		Y	DL	1.2	RLL		OL2	1		
25	1.2 D + 1.0 W3		Y	DL	1.2	RLL		OL3	1		
26	1.2 D + 1.0 W4		Y	DL	1.2	RLL		OL4	1		
27	0.9 D + 1.0 W1		Y	DL	0.9	RLL		OL1	1		
28	0.9 D + 1.0 W2		Y	DL	0.9	RLL		OL2	1		
29	0.9 D + 1.0 W3		Y	DL	0.9	RLL		OL3	1		
30	0.9 D + 1.0 W4		Y	DL	0.9	RLL		OL4	1		

Envelope Node Reactions

	Node Label		X [lb]	LC	Y [lb]	LC	Z [lb]	LC	MX [lb-ft]	LC	MY [lb-ft]	LC	MZ [lb-ft]	LC
1	N2	max	4.651	12	1160.785	9	37.393	4	0	15	0	15	0	15
2		min	-26.344	11	110.541	12	-44.265	6	0	2	0	2	0	2
3	N1	max	29.209	10	2128.02	10	1026.76	6	0	15	0	15	0	15
4		min	-24.324	13	-1474.806	13	-891.638	4	0	2	0	2	0	2
5	N109	max	0.395	13	2050.321	10	1096.188	6	0	15	0	15	0	15
6		min	-0.914	10	-1461.952	13	-946.917	4	0	2	0	2	0	2
7	N110A	max	3.084	12	1241.353	9	38.447	4	0	15	0	15	0	15
8		min	-8.278	11	96.094	14	-46.192	6	0	2	0	2	0	2
9	N151	max	24.822	13	2127.554	10	1026.541	6	0	15	0	15	0	15
10		min	-29.735	10	-1474.339	13	-891.439	4	0	2	0	2	0	2
11	N152	max	26.423	11	1160.864	9	37.389	4	0	15	0	15	0	15
12		min	-4.69	12	110.705	12	-44.26	6	0	2	0	2	0	2
13	N237	max	0.255	13	2112.816	10	1034.356	6	0	15	0	15	0	15
14		min	-0.227	10	-1460.999	13	-898.588	4	0	2	0	2	0	2
15	N239	max	1.004	6	1186.2	9	38.028	4	0	15	0	15	0	15
16		min	-0.787	12	75.23	12	-45.781	6	0	2	0	2	0	2
17	N244	max	4.592	10	2178.757	10	1123.102	6	0	15	0	15	0	15
18		min	-2.863	13	-1559.409	13	-973.411	4	0	2	0	2	0	2
19	N246	max	15.605	11	1270.457	9	39.318	4	0	15	0	15	0	15
20		min	-4.384	12	75.087	14	-46.707	6	0	2	0	2	0	2
21	N250	max	0.957	12	1191.663	9	38.255	4	0	15	0	15	0	15
22		min	-12.205	11	104.474	12	-45.808	6	0	2	0	2	0	2
23	N253	max	3.787	10	2089.624	10	1047.003	6	0	15	0	15	0	15
24		min	-2.756	13	-1451.901	13	-907.556	4	0	2	0	2	0	2
25	N255	max	9.982	11	1178.576	9	38.078	4	0	15	0	15	0	15
26		min	-0.729	12	95.215	12	-45.667	6	0	2	0	2	0	2
27	N257	max	3.366	13	2101.292	10	1057.158	6	0	15	0	15	0	15
28		min	-4.632	10	-1466.545	13	-916.362	4	0	2	0	2	0	2
29	N260	max	4.628	10	2101.296	10	1057.158	6	0	15	0	15	0	15
30		min	-3.357	13	-1466.551	13	-916.362	4	0	2	0	2	0	2
31	N264	max	13.17	11	1268.009	9	39.342	4	0	15	0	15	0	15
32		min	-4.429	12	80.713	14	-46.737	6	0	2	0	2	0	2
33	N267	max	12.271	11	1191.661	9	38.255	4	0	15	0	15	0	15
34		min	-1.044	12	104.473	12	-45.808	6	0	2	0	2	0	2
35	N268	max	0.051	14	1180.289	9	38.194	4	0	15	0	15	0	15

Envelope Node Reactions (Continued)

Node Label		X [lb]	LC	Y [lb]	LC	Z [lb]	LC	MX [lb-ft]	LC	MY [lb-ft]	LC	MZ [lb-ft]	LC	
36		min	-0.044	4	71.481	12	-45.916	6	0	2	0	2	0	2
37	N271	max	2.088	13	2180.464	10	1119.408	6	0	15	0	15	0	15
38		min	-3.53	10	-1557.843	13	-970.545	4	0	2	0	2	0	2
39	N273	max	4.344	12	1267.996	9	39.342	4	0	15	0	15	0	15
40		min	-13.106	11	80.733	14	-46.737	6	0	2	0	2	0	2
41	N275	max	0.005	13	2091.613	10	1031.435	6	0	15	0	15	0	15
42		min	-0.006	7	-1443.687	13	-893.755	4	0	2	0	2	0	2
43	N281	max	3.527	10	2180.479	10	1119.428	6	0	15	0	15	0	15
44		min	-2.079	13	-1557.856	13	-970.562	4	0	2	0	2	0	2
45	N286	max	0.701	12	1186.041	9	38.029	4	0	15	0	15	0	15
46		min	-0.927	10	75.2	12	-45.782	6	0	2	0	2	0	2
47	N289	max	4.297	12	1270.499	9	39.318	4	0	15	0	15	0	15
48		min	-15.538	11	75.067	14	-46.708	6	0	2	0	2	0	2
49	N293	max	0.933	10	2050.648	10	1096.477	6	0	15	0	15	0	15
50		min	-0.401	13	-1462.731	13	-947.183	4	0	2	0	2	0	2
51	N297	max	8.33	11	1241.862	9	38.451	4	0	15	0	15	0	15
52		min	-3.193	12	96.082	14	-46.196	6	0	2	0	2	0	2
53	N298	max	2.766	13	2089.642	10	1047.022	6	0	15	0	15	0	15
54		min	-3.792	10	-1451.909	13	-907.571	4	0	2	0	2	0	2
55	N299	max	0.642	12	1178.586	9	38.079	4	0	15	0	15	0	15
56		min	-9.917	11	95.223	12	-45.668	6	0	2	0	2	0	2
57	N301	max	2.872	13	2178.809	10	1123.132	6	0	15	0	15	0	15
58		min	-4.595	10	-1559.473	13	-973.436	4	0	2	0	2	0	2
59	N306	max	0.22	10	2112.665	10	1034.304	6	0	15	0	15	0	15
60		min	-0.241	13	-1460.755	13	-898.533	4	0	2	0	2	0	2
61	Totals:	max	-0.002	13	45037.025	10	15351.24	14						
62		min	-0.005	7	-17347.858	12	-13327.941	4						

Envelope AISC 15TH (360-16): ASD Member Steel Code Checks

Member	Shape	Code Check	Loc[in]	LC	Shear	Check	Loc[in]	Dir	LC	Pnc/om [lb]	Pnt/om [lb]	Mnyy/om [lb-ft]	Mnzz/om [lb-ft]	Cb	Eqn
1	M138	1.5X1.5X0.083	0.802	62.776	6	0.008	120.53	y	10	1634.463	14085.15	624.421	624.421	1.136	H1-1a
2	M116	1.5X1.5X0.083	0.802	62.776	6	0.008	120.53	y	10	1634.463	14085.15	624.421	624.421	1.136	H1-1a
3	M133	1.5X1.5X0.083	0.799	62.776	6	0.007	120.53	y	10	1634.463	14085.15	624.421	624.421	1.136	H1-1a
4	M127	1.5X1.5X0.083	0.799	62.776	6	0.007	120.53	y	10	1634.463	14085.15	624.421	624.421	1.136	H1-1a
5	M143	1.5X1.5X0.083	0.782	62.776	6	0.004	120.53	y	10	1634.463	14085.15	624.421	624.421	1.136	H1-1a
6	M52	1.5X1.5X0.083	0.782	62.776	6	0.004	120.53	y	10	1634.463	14085.15	624.421	624.421	1.136	H1-1a
7	M130	1.5X1.5X0.083	0.756	62.776	6	0.006	120.53	y	3	1634.463	14085.15	624.421	624.421	1.136	H1-1a
8	M118	1.5X1.5X0.083	0.756	62.776	6	0.006	120.53	y	3	1634.463	14085.15	624.421	624.421	1.136	H1-1a
9	M140	1.5X1.5X0.083	0.748	62.776	6	0.005	120.53	y	3	1634.463	14085.15	624.421	624.421	1.136	H1-1a
10	M121	1.5X1.5X0.083	0.748	62.776	6	0.005	120.53	y	3	1634.463	14085.15	624.421	624.421	1.136	H1-1a
11	M112	1.5X1.5X0.083	0.739	62.776	6	0.002	120.53	y	6	1634.463	14085.15	624.421	624.421	1.136	H1-1a
12	M146	1.5X1.5X0.083	0.739	62.776	6	0.002	120.53	y	6	1634.463	14085.15	624.421	624.421	1.136	H1-1a
13	M124	1.5X1.5X0.083	0.737	62.776	6	0.002	120.53	y	10	1634.463	14085.15	624.421	624.421	1.136	H1-1a
14	M15	1.5X1.5X0.083	0.736	62.776	6	0.011	0	y	5	1634.454	14085.15	624.421	624.421	1.136	H1-1a
15	M75	1.5X1.5X0.083	0.736	62.776	6	0.011	120.53	y	5	1634.463	14085.15	624.421	624.421	1.136	H1-1a
16	M142	PIPE2.0A21165	0.599	3.739	6	0.169	0		6	5242.145	23232.186	1397.505	1397.505	1	H1-1a
17	M115	PIPE2.0A21165	0.599	3.739	6	0.169	0		6	5242.145	23232.186	1397.505	1397.505	1	H1-1a
18	M132	PIPE2.0A21165	0.598	3.739	6	0.169	0		6	5242.145	23232.186	1397.505	1397.505	1	H1-1a
19	M126	PIPE2.0A21165	0.598	3.739	6	0.169	0		6	5242.145	23232.186	1397.505	1397.505	1	H1-1a
20	M136	PIPE2.0A21165	0.573	3.739	6	0.165	0		6	5242.145	23232.186	1397.505	1397.505	1	H1-1a
21	M51	PIPE2.0A21165	0.573	3.739	6	0.165	0		6	5242.145	23232.186	1397.505	1397.505	1	H1-1a
22	M6	PIPE2.0A21165	0.569	3.739	10	0.156	0		6	5242.145	23232.186	1397.505	1397.505	1	H1-1a
23	M74	PIPE2.0A21165	0.569	3.739	10	0.156	0		6	5242.145	23232.186	1397.505	1397.505	1	H1-1a
24	M135	PIPE2.0A21165	0.568	3.739	6	0.159	0		6	5242.145	23232.186	1397.505	1397.505	1	H1-1a
25	M123	PIPE2.0A21165	0.568	3.739	6	0.159	0		6	5242.145	23232.186	1397.505	1397.505	1	H1-1a

Envelope AISC 15TH (360-16): ASD Member Steel Code Checks (Continued)

Member	Shape	Code Check	Loc[in]	LC	Shear Check	Loc[in]	Dir	LC	Pnc/om [lb]	Pnt/om [lb]	Mnyy/om [lb-ft]	Mnzz/om [lb-ft]	Cb	Eqn	
26	M114	PIPE2.0A21165	0.566	3.739	10	0.156	0	6	5242.145	23232.186	1397.505	1397.505	1	H1-1a	
27	M145	PIPE2.0A21165	0.566	3.739	10	0.156	0	6	5242.145	23232.186	1397.505	1397.505	1	H1-1a	
28	M137	PIPE2.0A21165	0.563	3.739	10	0.158	0	6	5242.145	23232.186	1397.505	1397.505	1	H1-1a	
29	M120	PIPE2.0A21165	0.563	3.739	10	0.158	0	6	5242.145	23232.186	1397.505	1397.505	1	H1-1a	
30	M129	PIPE2.0A21165	0.561	3.739	10	0.155	0	6	5242.145	23232.186	1397.505	1397.505	1	H1-1a	
31	M72	PIPE2.5A21168	0.456	30.75	11	0.119	625.25	11	20336.2	28358.413	2081.747	2081.747	1	H1-1b	
32	M71	PIPE2.5A21168	0.43	953.25	10	0.131	358.75	10	20336.2	28358.413	2081.747	2081.747	1	H1-1b	
33	M117	PIPE2.0A21165	0.17	53.493	6	0.159	53.493	6	16304.154	23232.186	1397.505	1397.505	1	H1-1b	
34	M134	PIPE2.0A21165	0.17	53.493	6	0.158	53.493	6	16304.154	23232.186	1397.505	1397.505	1	H1-1b	
35	M139	PIPE2.0A21165	0.17	53.493	6	0.159	53.493	6	16304.154	23232.186	1397.505	1397.505	1	H1-1b	
36	M128	PIPE2.0A21165	0.17	53.493	6	0.158	53.493	6	16304.154	23232.186	1397.505	1397.505	1	H1-1b	
37	M125	PIPE2.0A21165	0.168	53.493	6	0.145	53.493	6	16304.154	23232.186	1397.505	1397.505	1	H1-1b	
38	M144	PIPE2.0A21165	0.167	53.493	6	0.155	53.493	6	16304.154	23232.186	1397.505	1397.505	1	H1-1b	
39	M50	PIPE2.0A21165	0.167	53.493	6	0.155	53.493	6	16304.154	23232.186	1397.505	1397.505	1	H1-1b	
40	M113	PIPE2.0A21165	0.167	53.493	6	0.145	53.493	6	16304.154	23232.186	1397.505	1397.505	1	H1-1b	
41	M147	PIPE2.0A21165	0.167	53.493	6	0.145	53.493	6	16304.154	23232.186	1397.505	1397.505	1	H1-1b	
42	M131	PIPE2.0A21165	0.167	53.493	6	0.149	53.493	6	16304.154	23232.186	1397.505	1397.505	1	H1-1b	
43	M119	PIPE2.0A21165	0.167	53.493	6	0.149	53.493	6	16304.154	23232.186	1397.505	1397.505	1	H1-1b	
44	M73	PIPE2.0A21165	0.166	53.493	11	0.146	53.493	6	16304.154	23232.186	1397.505	1397.505	1	H1-1b	
45	M122	PIPE2.0A21165	0.166	53.493	6	0.147	53.493	6	16304.154	23232.186	1397.505	1397.505	1	H1-1b	
46	M141	PIPE2.0A21165	0.166	53.493	6	0.147	53.493	6	16304.154	23232.186	1397.505	1397.505	1	H1-1b	
47	M5	PIPE2.0A21165	0.166	53.493	11	0.146	53.493	6	16304.154	23232.186	1397.505	1397.505	1	H1-1b	
48	M19	1.5X1.5X0.083	0.052	77.693	10	0.025	77.693	y	6	3933.681	14085.15	624.421	624.421	1.136	H1-1b*
49	M75B	1.5X1.5X0.083	0.052	77.816	10	0.025	77.816	y	6	3921.257	14085.15	624.421	624.421	1.136	H1-1b*

Envelope AA ADM1-15: ASD - BUILDING Member Aluminum Code Checks

Member	Shape	Code Check	Loc[in]	LC	Shear Check	Loc[in]	Dir	LC	Pnc/om [lb]	Pnt/om [lb]	Mny/om [lb-ft]	Mnz/om [lb-ft]	Vny/om [lb]	Vnz/om [lb]	Cb	Eqn	
1	M41	HR300 ALA	0.939	105	10	0.076	43.75	y	11	2314.016	14342.564	533.921	934.619	7307.692	3206.154	1.68	H.1-1
2	M95	HR300 ALA	0.939	105	10	0.076	43.75	y	11	2314.016	14342.564	533.921	934.619	7307.692	3206.154	1.68	H.1-1
3	M77	HR300 ALA	0.937	105	10	0.076	43.75	y	11	2314.016	14342.564	533.921	934.619	7307.692	3206.154	1.68	H.1-1
4	M60	HR300 ALA	0.937	105	10	0.076	43.75	y	11	2314.016	14342.564	533.921	934.619	7307.692	3206.154	1.68	H.1-1
5	M29	HR300 ALA	0.933	105	10	0.077	43.75	y	11	2314.016	14342.564	533.921	934.619	7307.692	3206.154	1.677	H.1-1
6	M103	HR300 ALA	0.933	105	10	0.077	43.75	y	11	2314.016	14342.564	533.921	934.619	7307.692	3206.154	1.677	H.1-1
7	M85	HR300 ALA	0.931	105	10	0.077	168.438	y	10	2314.016	14342.564	533.921	934.619	7307.692	3206.154	1.675	H.1-1
8	M54	HR300 ALA	0.931	105	10	0.077	168.438	y	10	2314.016	14342.564	533.921	934.619	7307.692	3206.154	1.675	H.1-1
9	M47	HR300 ALA	0.929	105	10	0.077	168.438	y	10	2314.016	14342.564	533.921	934.619	7307.692	3206.154	1.674	H.1-1
10	M89	HR300 ALA	0.929	105	10	0.077	168.438	y	10	2314.016	14342.564	533.921	934.619	7307.692	3206.154	1.674	H.1-1
11	M101	HR300 ALA	0.926	105	10	0.076	43.75	y	11	2314.016	14342.564	533.921	934.619	7307.692	3206.154	1.673	H.1-1
12	M32	HR300 ALA	0.926	105	10	0.076	43.75	y	11	2314.016	14342.564	533.921	934.619	7307.692	3206.154	1.673	H.1-1
13	M66	HR300 ALA	0.924	105	10	0.076	43.75	y	11	2314.016	14342.564	533.921	934.619	7307.692	3206.154	1.672	H.1-1
14	M63	HR300 ALA	0.924	105	10	0.076	43.75	y	11	2314.016	14342.564	533.921	934.619	7307.692	3206.154	1.672	H.1-1
15	M38	HR300 ALA	0.923	105	10	0.076	43.75	y	11	2314.016	14342.564	533.921	934.619	7307.692	3206.154	1.671	H.1-1
16	M97	HR300 ALA	0.923	105	10	0.076	43.75	y	11	2314.016	14342.564	533.921	934.619	7307.692	3206.154	1.671	H.1-1
17	M91	HR300 ALA	0.92	105	10	0.076	43.75	y	11	2314.016	14342.564	533.921	934.619	7307.692	3206.154	1.67	H.1-1
18	M44	HR300 ALA	0.92	105	10	0.076	43.75	y	11	2314.016	14342.564	533.921	934.619	7307.692	3206.154	1.67	H.1-1
19	M57	HR300 ALA	0.92	105	10	0.076	43.75	y	11	2314.016	14342.564	533.921	934.619	7307.692	3206.154	1.669	H.1-1
20	M83	HR300 ALA	0.92	105	10	0.076	43.75	y	11	2314.016	14342.564	533.921	934.619	7307.692	3206.154	1.669	H.1-1
21	M35	HR300 ALA	0.897	102.813	10	0.078	43.75	y	11	2314.016	14342.564	533.921	934.619	7307.692	3206.154	1.665	H.1-1
22	M107	HR300 ALA	0.883	102.813	10	0.077	43.75	y	11	2314.016	14342.564	533.921	934.619	7307.692	3206.154	1.653	H.1-1
23	M16	HR300 ALA	0.84	105	10	0.075	168.438	y	10	2314.016	14342.564	533.921	934.619	7307.692	3206.154	1.603	H.1-1
24	M109	HR300 ALA	0.839	105	10	0.075	168.438	y	10	2314.016	14342.564	533.921	934.619	7307.692	3206.154	1.603	H.1-1

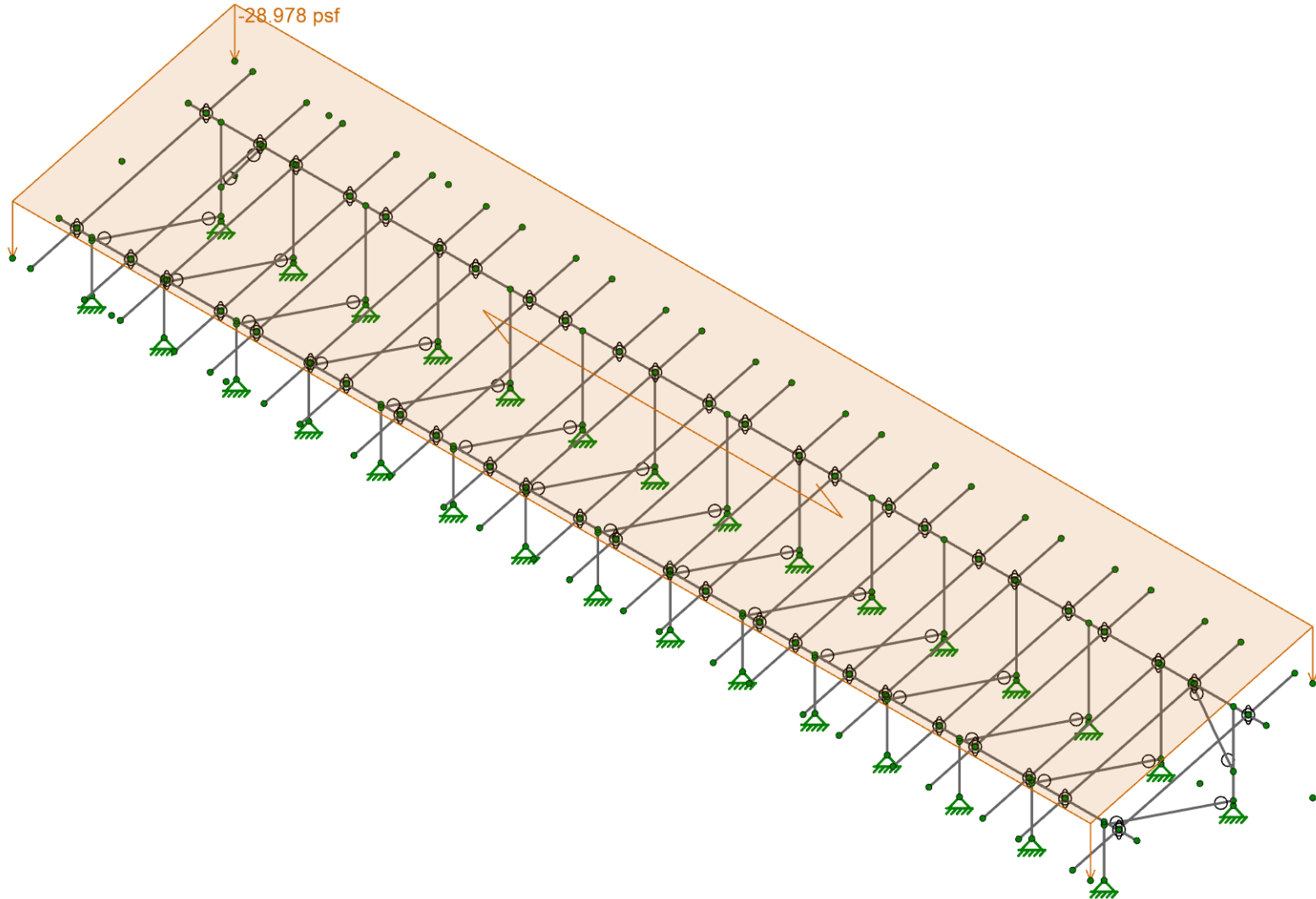
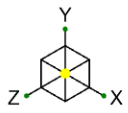

Loads: BLC 3, Roof Live/Snow

Vector Structural Engineering
LKN
U2716.0366.231

Sunturf Ground Mount B7 SF 15°

SK-1
Feb 02, 2023
Sunturf Ground Mount B7 82x42 15deg.r3d

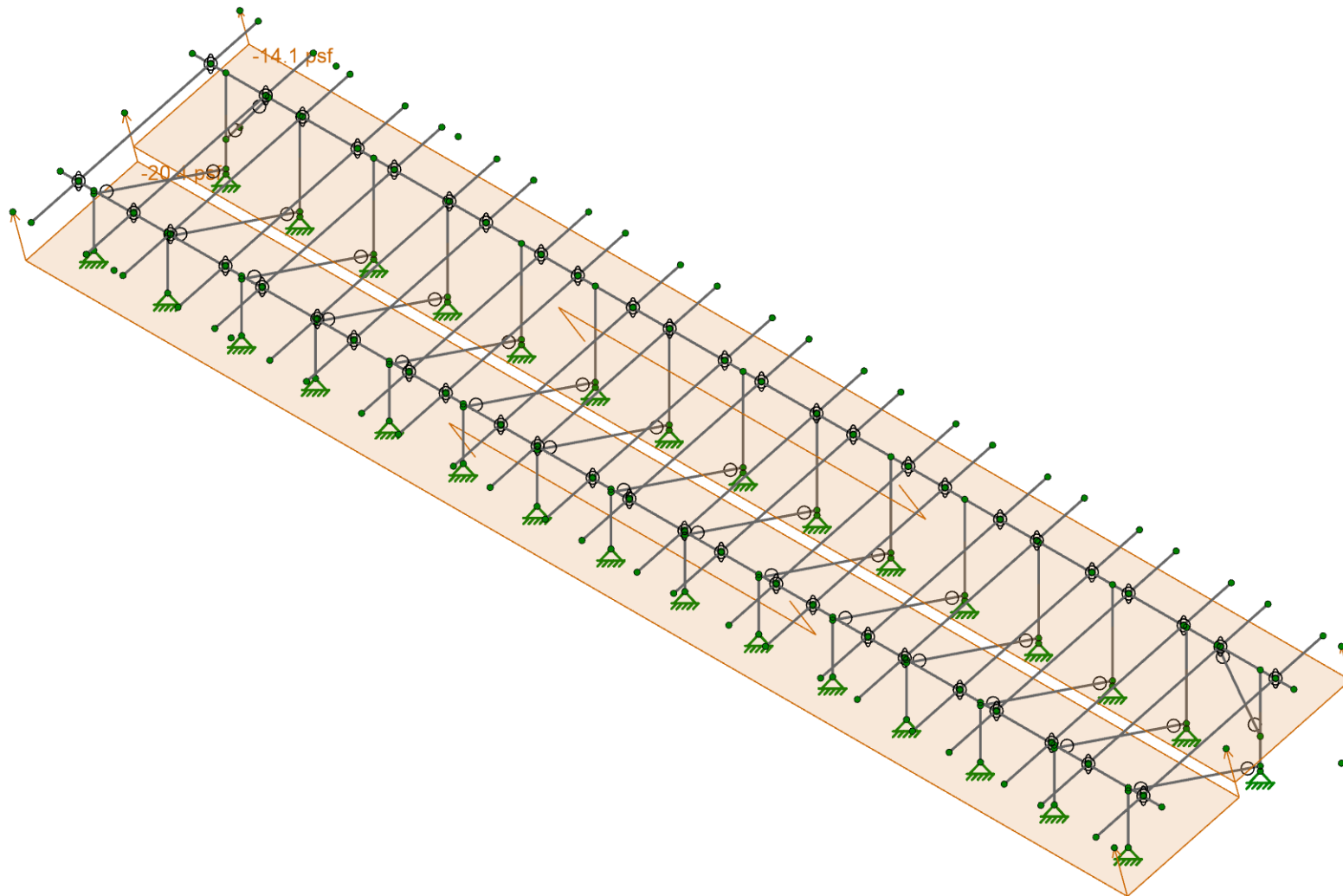
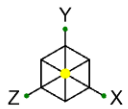

Loads: BLC 4, Wind A 0 deg

Vector Structural Engineering
LKN
U2716.0366.231

Sunturf Ground Mount B7 SF 15°

SK-2
Feb 02, 2023
Sunturf Ground Mount B7 82x42 15deg.r3d

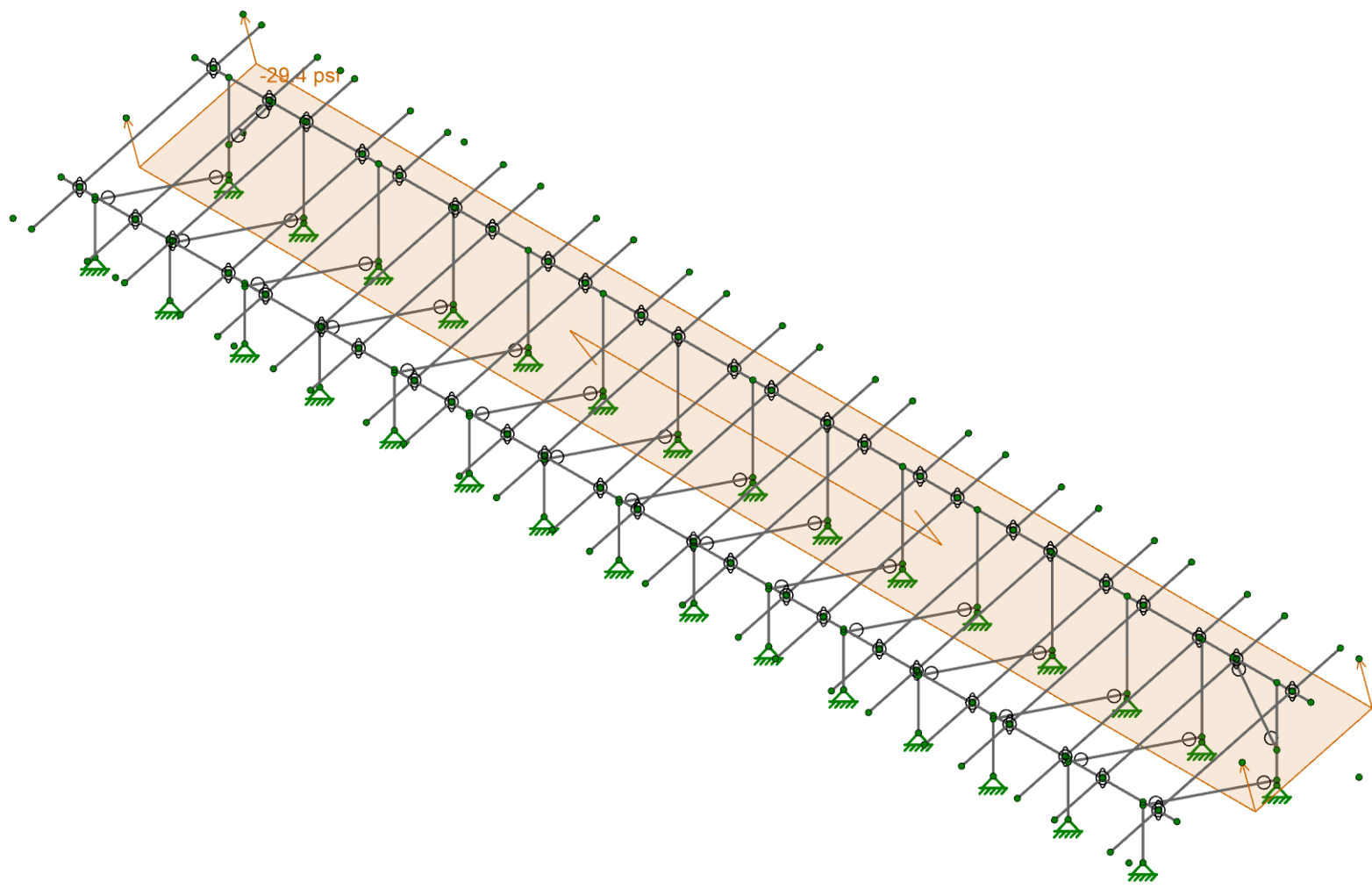
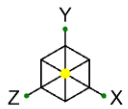

Loads: BLC 5, Wind B 0 deg

Vector Structural Engineering
LKN
U2716.0366.231

Sunturf Ground Mount B7 SF 15°

SK-3
Feb 02, 2023
Sunturf Ground Mount B7 82x42 15deg.r3d

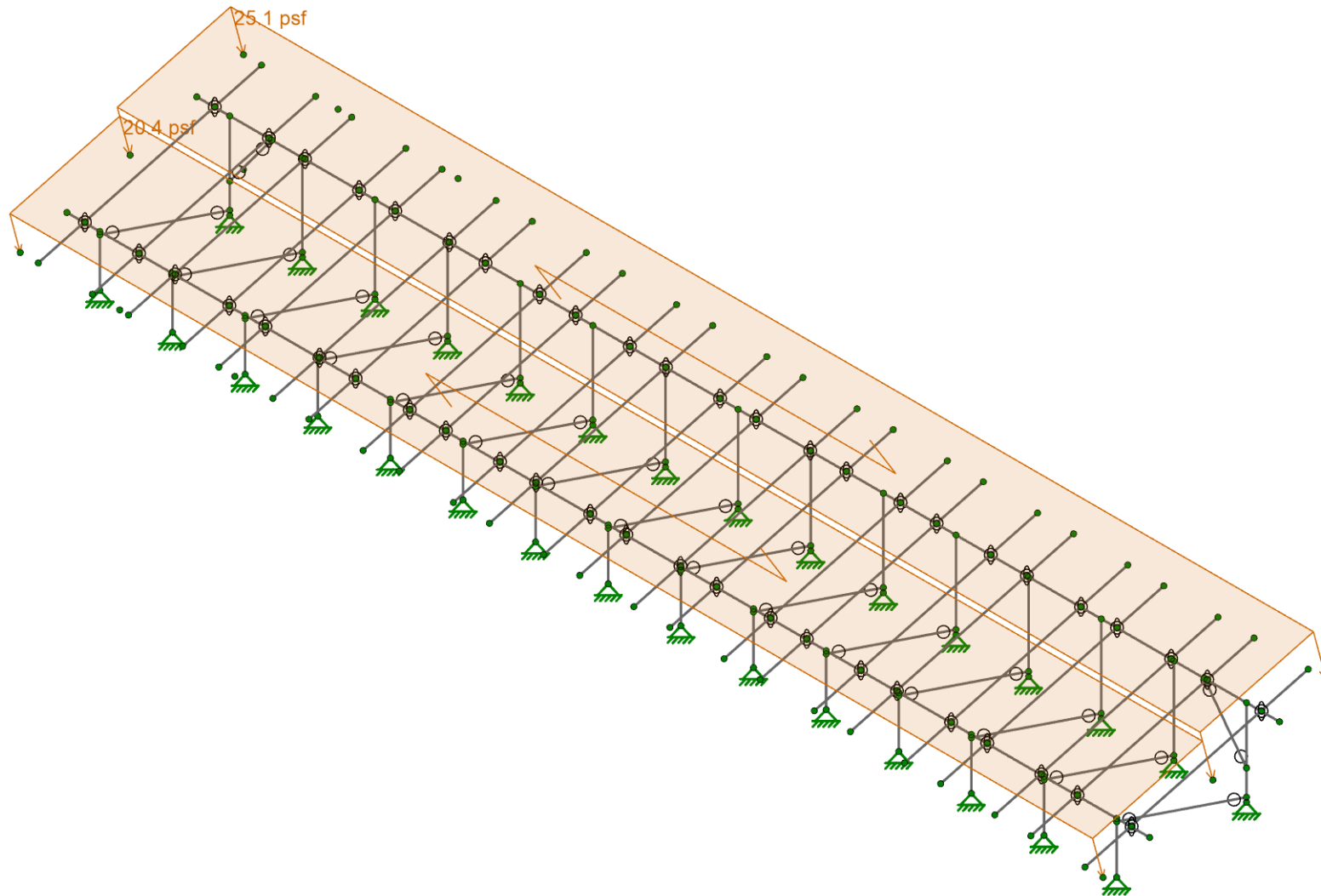
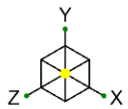

Loads: BLC 6, Wind A 180 deg

Vector Structural Engineering
LKN
U2716.0366.231

Sunturf Ground Mount B7 SF 15°

SK-4
Feb 02, 2023
Sunturf Ground Mount B7 82x42 15deg.r3d

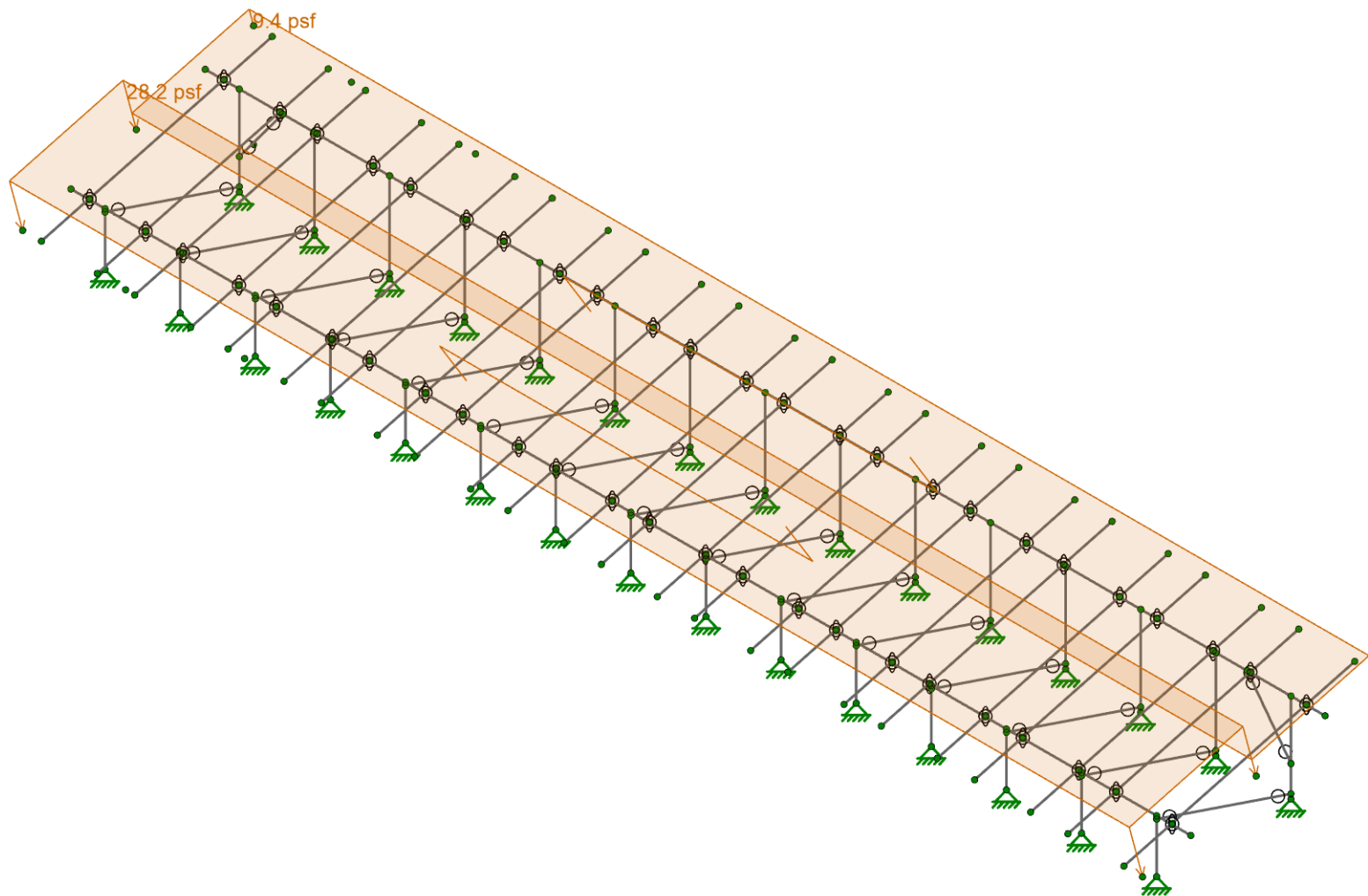
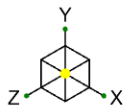

Loads: BLC 7, Wind B 180 deg

Vector Structural Engineering
LKN
U2716.0366.231

Sunturf Ground Mount B7 SF 15°

SK-5
Feb 02, 2023
Sunturf Ground Mount B7 82x42 15deg.r3d

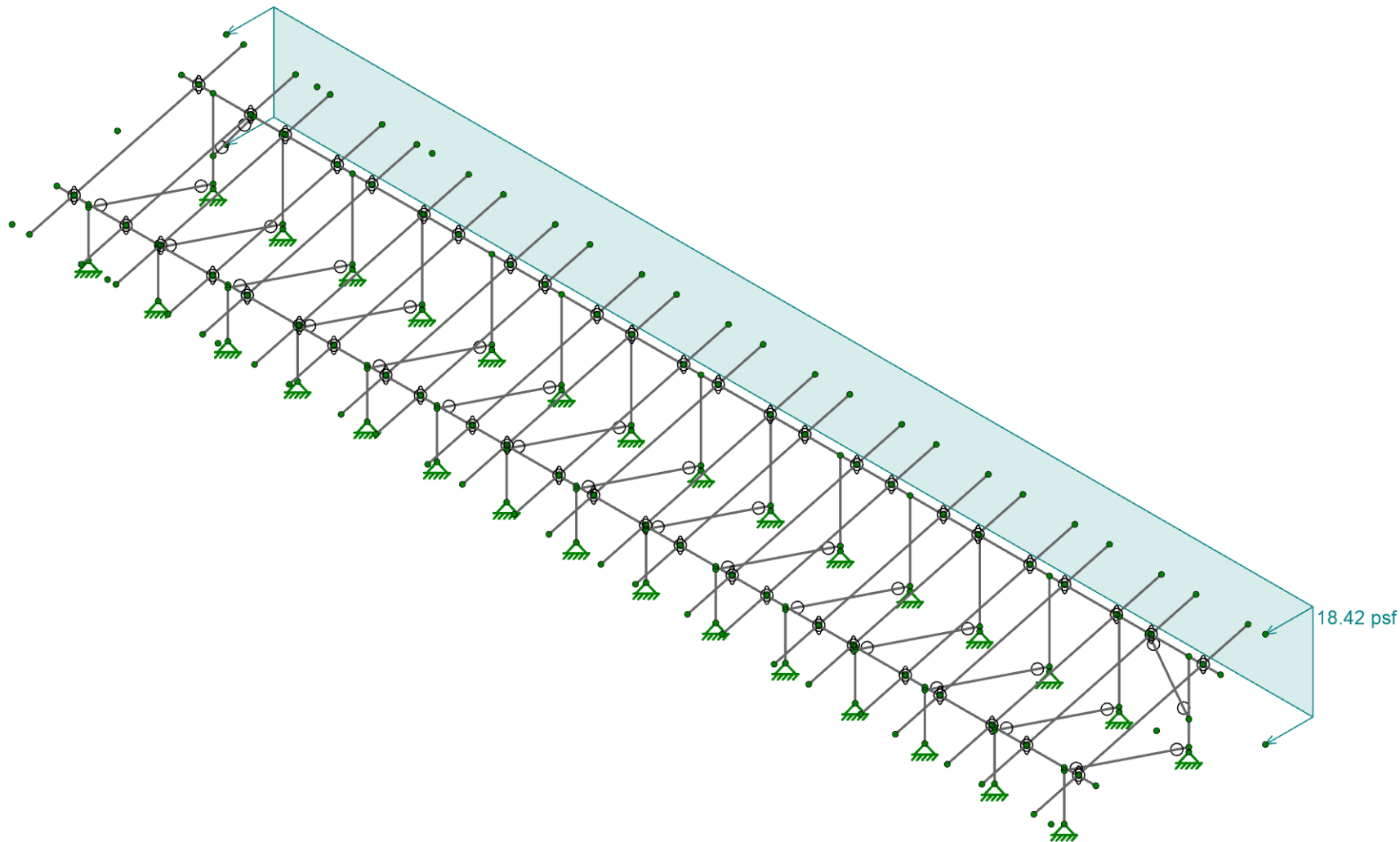
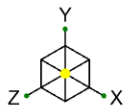

Loads: BLC 8, Wind Z

Vector Structural Engineering
LKN
U2716.0366.231

Sunturf Ground Mount B7 SF 15°

SK-6
Feb 02, 2023
Sunturf Ground Mount B7 82x42 15deg.r3d

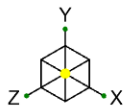

Shear Check (Env)

- No Calc
- > 1.0
- .90-1.0
- .75-.90
- .50-.75
- 0-.50

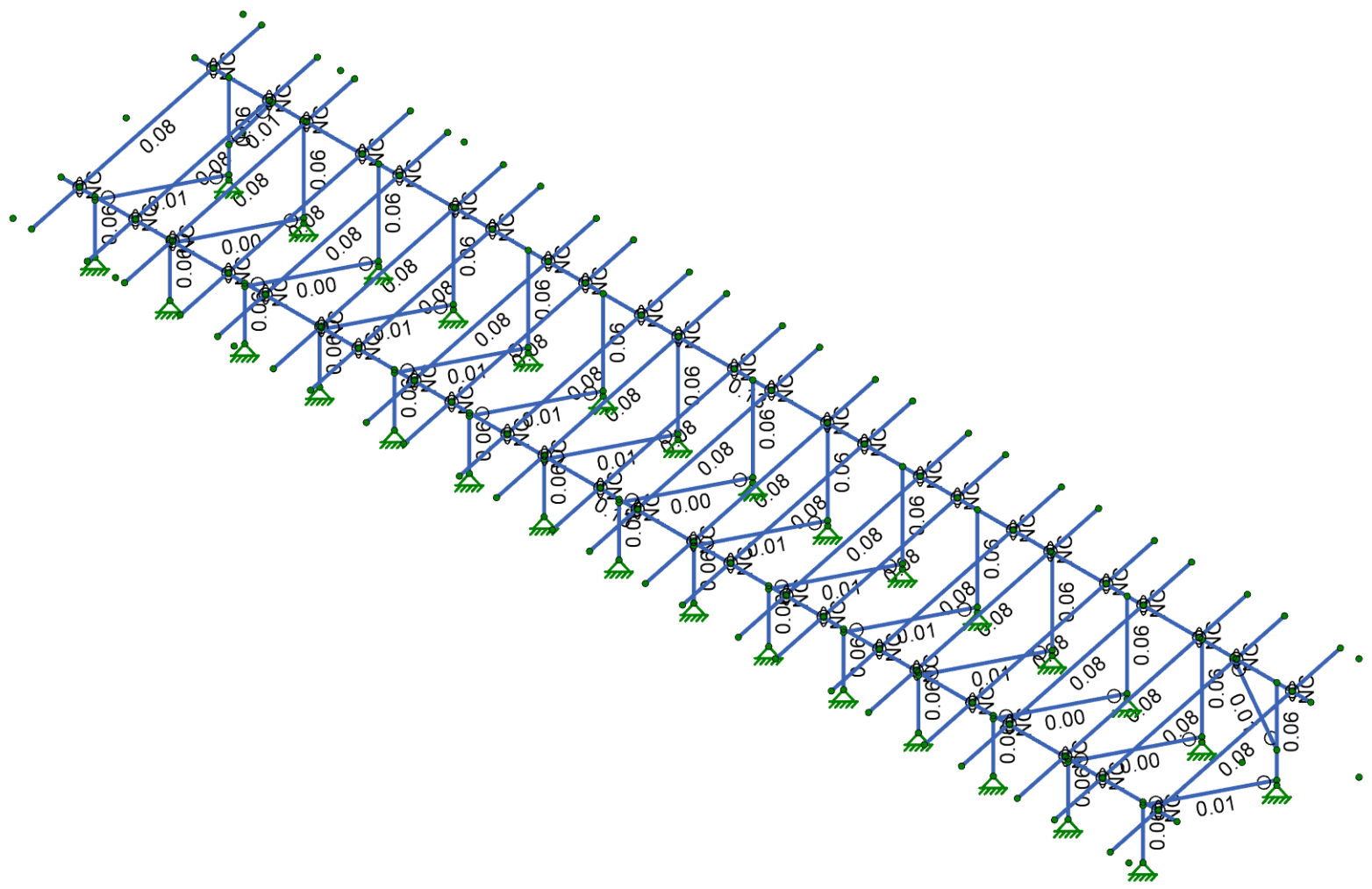

Member Shear Checks Displayed (Enveloped)		
Vector Structural Engineering	Sunturf Ground Mount B7 SF 15°	SK-8
LKN		Feb 02, 2023
U2716.0366.231		Sunturf Ground Mount B7 82x42 15deg.r3d

Basic Load Cases

	BLC Description	Category	Y Gravity	Distributed	Area(Member)
1	Self Weight	DL	-1.05		
2	Solar Panel Weight	DL			1
3	Roof Live/Snow	RLL			1
4	Wind A 0 deg	OL1			2
5	Wind B 0 deg	OL2			2
6	Wind A 180 deg	OL3			2
7	Wind B 180 deg	OL4			2
8	Wind Z	WLZ			1
9	BLC 2 Transient Area Loads	None		52	
10	BLC 3 Transient Area Loads	None		52	
11	BLC 4 Transient Area Loads	None		160	
12	BLC 5 Transient Area Loads	None		80	
13	BLC 6 Transient Area Loads	None		160	
14	BLC 7 Transient Area Loads	None		160	
15	BLC 8 Transient Area Loads	None		104	

Member Area Loads (BLC 2 : Solar Panel Weight)

	Node A	Node B	Node C	Node D	Direction	Load Direction	Magnitude [psf]
1	N197	N200	N199	N196	Y	A-B	-3

Member Area Loads (BLC 3 : Roof Live/Snow)

	Node A	Node B	Node C	Node D	Direction	Load Direction	Magnitude [psf]
1	N197	N200	N199	N196	PY	A-B	-30

Member Area Loads (BLC 4 : Wind A 0 deg)

	Node A	Node B	Node C	Node D	Direction	Load Direction	Magnitude [psf]
1	N197	N200	N201	N198	Perp	A-B	-14.1
2	N198	N201	N199	N196	Perp	A-B	-20.4

Member Area Loads (BLC 5 : Wind B 0 deg)

	Node A	Node B	Node C	Node D	Direction	Load Direction	Magnitude [psf]
1	N197	N200	N201	N198	Perp	A-B	-29.4
2	N198	N201	N199	N196	Perp	A-B	0

Member Area Loads (BLC 6 : Wind A 180 deg)

	Node A	Node B	Node C	Node D	Direction	Load Direction	Magnitude [psf]
1	N197	N200	N201	N198	Perp	A-B	25.1
2	N198	N201	N199	N196	Perp	A-B	20.4

Member Area Loads (BLC 7 : Wind B 180 deg)

	Node A	Node B	Node C	Node D	Direction	Load Direction	Magnitude [psf]
1	N197	N200	N201	N198	Perp	A-B	9.4
2	N198	N201	N199	N196	Perp	A-B	28.2



Company : Vector Structural Engineering
 Designer : LKN
 Job Number : U2716.0366.231
 Model Name : Sunturf Ground Mount B7 SF 15°

2/7/2023
 12:07:54 PM
 Checked By : _____

Member Area Loads (BLC 8 : Wind Z)

	Node A	Node B	Node C	Node D	Direction	Load Direction	Magnitude [psf]
1	N200	N197	N307	N308	Z	Open Structure	18.42

Load Combinations

	Description	Solve	P-Delta	BLC	Factor	BLC	Factor	BLC	Factor	BLC	Factor
1	ASD Loads		Y								
2	1.0 D	Yes	Y	DL	1						
3	1.0 D + 1.0 S	Yes	Y	DL	1	RLL	1				
4	1.0 D + 0.6 W1	Yes	Y	DL	1	RLL		OL1	0.6	WLZ	0.6
5	1.0 D + 0.6 W2	Yes	Y	DL	1	RLL		OL2	0.6	WLZ	0.6
6	1.0 D + 0.6 W3	Yes	Y	DL	1	RLL		OL3	0.6	WLZ	-0.6
7	1.0 D + 0.6 W4	Yes	Y	DL	1	RLL		OL4	0.6	WLZ	-0.6
8	1.0 D + 0.45 W1 + 0.75 S	Yes	Y	DL	1	RLL	0.75	OL1	0.45	WLZ	0.45
9	1.0 D + 0.45 W2 + 0.75 S	Yes	Y	DL	1	RLL	0.75	OL2	0.45	WLZ	0.45
10	1.0 D + 0.45 W3 + 0.75 S	Yes	Y	DL	1	RLL	0.75	OL3	0.45	WLZ	-0.45
11	1.0 D + 0.45 W4 + 0.75 S	Yes	Y	DL	1	RLL	0.75	OL4	0.45	WLZ	-0.45
12	0.6 D + 0.6 W1	Yes	Y	DL	0.6	RLL		OL1	0.6	WLZ	0.6
13	0.6 D + 0.6 W2	Yes	Y	DL	0.6	RLL		OL2	0.6	WLZ	0.6
14	0.6 D + 0.6 W3	Yes	Y	DL	0.6	RLL		OL3	0.6	WLZ	-0.6
15	0.6 D + 0.6 W4	Yes	Y	DL	0.6	RLL		OL4	0.6	WLZ	-0.6
16			Y								
17	LRFD Loads		Y								
18	1.4 D		Y	DL	1.4	RLL					
19	1.2 D + 1.6 S + 0.5 W1		Y	DL	1.2	RLL	1.6	OL1	0.5		
20	1.2 D + 1.6 S + 0.5 W2		Y	DL	1.2	RLL	1.6	OL2	0.5		
21	1.2 D + 1.6 S + 0.5 W3		Y	DL	1.2	RLL	1.6	OL3	0.5		
22	1.2 D + 1.6 S + 0.5 W4		Y	DL	1.2	RLL	1.6	OL4	0.5		
23	1.2 D + 1.0 W1		Y	DL	1.2	RLL		OL1	1		
24	1.2 D + 1.0 W2		Y	DL	1.2	RLL		OL2	1		
25	1.2 D + 1.0 W3		Y	DL	1.2	RLL		OL3	1		
26	1.2 D + 1.0 W4		Y	DL	1.2	RLL		OL4	1		
27	0.9 D + 1.0 W1		Y	DL	0.9	RLL		OL1	1		
28	0.9 D + 1.0 W2		Y	DL	0.9	RLL		OL2	1		
29	0.9 D + 1.0 W3		Y	DL	0.9	RLL		OL3	1		
30	0.9 D + 1.0 W4		Y	DL	0.9	RLL		OL4	1		

Envelope Node Reactions

	Node Label		X [lb]	LC	Y [lb]	LC	Z [lb]	LC	MX [lb-ft]	LC	MY [lb-ft]	LC	MZ [lb-ft]	LC
1	N2	max	8.939	12	1596.042	11	13.881	4	0	15	0	15	0	15
2		min	-44.303	11	-258.882	12	-19.629	6	0	2	0	2	0	2
3	N1	max	90.783	10	2009.234	10	404.513	6	0	15	0	15	0	15
4		min	-41.784	13	-839.156	13	-319.72	4	0	2	0	2	0	2
5	N109	max	0.329	9	1752.225	10	429.058	6	0	15	0	15	0	15
6		min	-0.155	6	-755.514	13	-336.142	4	0	2	0	2	0	2
7	N110A	max	4.192	12	1679.591	11	14.403	4	0	15	0	15	0	15
8		min	-13.933	11	-283.293	12	-20.516	6	0	2	0	2	0	2
9	N151	max	41.813	13	2008.938	10	404.422	6	0	15	0	15	0	15
10		min	-90.811	10	-838.906	13	-319.65	4	0	2	0	2	0	2
11	N152	max	44.268	11	1595.877	11	13.879	4	0	15	0	15	0	15
12		min	-8.907	12	-258.741	12	-19.626	6	0	2	0	2	0	2
13	N237	max	0.392	13	1959.392	10	406.765	6	0	15	0	15	0	15
14		min	-0.872	10	-821.685	13	-323.076	4	0	2	0	2	0	2
15	N239	max	1.464	11	1696.588	11	14.228	4	0	15	0	15	0	15



Envelope Node Reactions (Continued)

Node Label		X [lb]	LC	Y [lb]	LC	Z [lb]	LC	MX [lb-ft]	LC	MY [lb-ft]	LC	MZ [lb-ft]	LC
16		min	12	-0.603	12	-288.049	6	0	2	0	2	0	2
17	N244	max	10	10.976	10	1951.483	6	0	15	0	15	0	15
18		min	13	-4.291	13	-836.344	4	0	2	0	2	0	2
19	N246	max	11	25.97	11	1692.365	4	0	15	0	15	0	15
20		min	12	-6.407	12	-275.567	6	0	2	0	2	0	2
21	N250	max	12	5.012	11	1655.108	4	0	15	0	15	0	15
22		min	11	-22.224	12	-275.98	6	0	2	0	2	0	2
23	N253	max	10	7.903	10	1903.469	6	0	15	0	15	0	15
24		min	13	-3.293	13	-801.329	4	0	2	0	2	0	2
25	N255	max	11	18.246	11	1649.243	4	0	15	0	15	0	15
26		min	12	-4.102	12	-276.082	6	0	2	0	2	0	2
27	N257	max	13	4.102	10	1909.342	6	0	15	0	15	0	15
28		min	10	-9.797	13	-805.995	4	0	2	0	2	0	2
29	N260	max	10	9.795	10	1909.349	6	0	15	0	15	0	15
30		min	13	-4.103	13	-805.999	4	0	2	0	2	0	2
31	N264	max	11	21.368	11	1695.7	4	0	15	0	15	0	15
32		min	12	-5.439	12	-276.693	6	0	2	0	2	0	2
33	N267	max	11	22.227	11	1655.105	4	0	15	0	15	0	15
34		min	12	-5.015	12	-275.979	6	0	2	0	2	0	2
35	N268	max	7	0.002	11	1691.791	4	0	15	0	15	0	15
36		min	12	-0.002	12	-288.915	6	0	2	0	2	0	2
37	N271	max	13	3.393	10	1958.827	6	0	15	0	15	0	15
38		min	10	-8.748	13	-838.358	4	0	2	0	2	0	2
39	N273	max	12	5.436	11	1695.699	4	0	15	0	15	0	15
40		min	11	-21.364	12	-276.694	6	0	2	0	2	0	2
41	N275	max	15	0	10	1925.365	6	0	15	0	15	0	15
42		min	10	-0.001	13	-808.154	4	0	2	0	2	0	2
43	N281	max	10	8.745	10	1958.816	6	0	15	0	15	0	15
44		min	13	-3.393	13	-838.354	4	0	2	0	2	0	2
45	N286	max	12	0.602	11	1696.582	4	0	15	0	15	0	15
46		min	11	-1.462	12	-288.039	6	0	2	0	2	0	2
47	N289	max	12	6.404	11	1692.368	4	0	15	0	15	0	15
48		min	11	-25.966	12	-275.572	6	0	2	0	2	0	2
49	N293	max	6	0.188	10	1752.828	6	0	15	0	15	0	15
50		min	9	-0.321	13	-755.906	4	0	2	0	2	0	2
51	N297	max	11	13.951	11	1679.654	4	0	15	0	15	0	15
52		min	12	-4.209	12	-283.377	6	0	2	0	2	0	2
53	N298	max	13	3.293	10	1903.462	6	0	15	0	15	0	15
54		min	10	-7.907	13	-801.326	4	0	2	0	2	0	2
55	N299	max	12	4.099	11	1649.241	4	0	15	0	15	0	15
56		min	11	-18.243	12	-276.079	6	0	2	0	2	0	2
57	N301	max	13	4.289	10	1951.534	6	0	15	0	15	0	15
58		min	10	-10.976	13	-836.371	4	0	2	0	2	0	2
59	N306	max	10	0.858	10	1959.145	6	0	15	0	15	0	15
60		min	13	-0.387	13	-821.549	4	0	2	0	2	0	2
61	Totals:	max	13	0.001	10	51361.859	6						
62		min	10	-0.001	12	-10728.094	12						

Envelope AISC 15TH (360-16): ASD Member Steel Code Checks

Member	Shape	Code Check	Loc[in]	LC	Shear Check	Loc[in]	Dir	LC	Pnc/om [lb]	Pnt/om [lb]	Mnny/om [lb-ft]	Mnzz/om [lb-ft]	Cb	Eqn
1	M72	PIPE2.5A21168	0.489	11	30.75	11	0.132	11	20336.2	28358.413	2081.747	2081.747	1	H1-1b
2	M71	PIPE2.5A21168	0.454	10	358.75	10	0.135	10	20336.2	28358.413	2081.747	2081.747	1	H1-1b
3	M116	1.5X1.5X0.083	0.347	6	63.562	6	0.009	10	1531.167	14085.15	624.421	624.421	1.136	H1-1a
4	M138	1.5X1.5X0.083	0.347	6	63.562	6	0.009	10	1531.167	14085.15	624.421	624.421	1.136	H1-1a
5	M133	1.5X1.5X0.083	0.346	6	63.562	6	0.008	10	1531.167	14085.15	624.421	624.421	1.136	H1-1a

Envelope AISC 15TH (360-16): ASD Member Steel Code Checks (Continued)

Member	Shape	Code Check	Loc[in]	Lc	Shear Check	Loc[in]	Dir	Lc	Pnc/om [lb]	Pnt/om [lb]	Mny/om [lb-ft]	Mnz/om [lb-ft]	Cb	Eqn	
6	M127	1.5X1.5X0.083	0.346	63.562	6	0.008	124.529	y	10	1531.167	14085.15	624.421	624.421	1.136	H1-1a
7	M143	1.5X1.5X0.083	0.338	63.562	6	0.004	124.529	y	11	1531.167	14085.15	624.421	624.421	1.136	H1-1a
8	M52	1.5X1.5X0.083	0.338	63.562	6	0.004	124.529	y	11	1531.167	14085.15	624.421	624.421	1.136	H1-1a
9	M130	1.5X1.5X0.083	0.327	63.562	6	0.008	124.529	y	3	1531.167	14085.15	624.421	624.421	1.136	H1-1a
10	M118	1.5X1.5X0.083	0.327	63.562	6	0.008	124.529	y	3	1531.167	14085.15	624.421	624.421	1.136	H1-1a
11	M140	1.5X1.5X0.083	0.324	63.562	6	0.007	124.529	y	3	1531.167	14085.15	624.421	624.421	1.136	H1-1a
12	M121	1.5X1.5X0.083	0.324	63.562	6	0.007	124.529	y	3	1531.167	14085.15	624.421	624.421	1.136	H1-1a
13	M112	1.5X1.5X0.083	0.321	63.562	6	0.002	124.529	y	8	1531.167	14085.15	624.421	624.421	1.136	H1-1a
14	M146	1.5X1.5X0.083	0.321	63.562	6	0.002	124.529	y	8	1531.167	14085.15	624.421	624.421	1.136	H1-1a
15	M124	1.5X1.5X0.083	0.32	63.562	6	0.002	124.529	y	10	1531.167	14085.15	624.421	624.421	1.136	H1-1a
16	M15	1.5X1.5X0.083	0.319	63.562	6	0.007	124.529	y	5	1531.161	14085.15	624.421	624.421	1.136	H1-1a
17	M75	1.5X1.5X0.083	0.319	63.562	6	0.007	124.529	y	5	1531.167	14085.15	624.421	624.421	1.136	H1-1a
18	M6	PIPE2.0A21165	0.316	78.413	10	0.06	0		6	11550.536	23232.186	1397.505	1397.505	1	H1-1b
19	M74	PIPE2.0A21165	0.315	78.413	10	0.06	0		6	11550.536	23232.186	1397.505	1397.505	1	H1-1b
20	M114	PIPE2.0A21165	0.17	0	10	0.06	0		6	11550.536	23232.186	1397.505	1397.505	1	H1-1b*
21	M145	PIPE2.0A21165	0.17	0	10	0.06	0		6	11550.536	23232.186	1397.505	1397.505	1	H1-1b*
22	M126	PIPE2.0A21165	0.17	0	10	0.064	0		6	11550.536	23232.186	1397.505	1397.505	1	H1-1b*
23	M132	PIPE2.0A21165	0.17	0	10	0.064	0		6	11550.536	23232.186	1397.505	1397.505	1	H1-1b*
24	M142	PIPE2.0A21165	0.169	0	10	0.065	0		6	11550.536	23232.186	1397.505	1397.505	1	H1-1b*
25	M115	PIPE2.0A21165	0.169	0	10	0.065	0		6	11550.536	23232.186	1397.505	1397.505	1	H1-1b*
26	M5	PIPE2.0A21165	0.168	43.929	11	0.057	43.929		6	18200.463	23232.186	1397.505	1397.505	1	H1-1b
27	M73	PIPE2.0A21165	0.168	43.929	11	0.057	43.929		6	18200.463	23232.186	1397.505	1397.505	1	H1-1b
28	M129	PIPE2.0A21165	0.167	0	10	0.059	0		6	11550.536	23232.186	1397.505	1397.505	1	H1-1b*
29	M135	PIPE2.0A21165	0.165	0	10	0.061	0		6	11550.536	23232.186	1397.505	1397.505	1	H1-1b*
30	M123	PIPE2.0A21165	0.165	0	10	0.061	0		6	11550.536	23232.186	1397.505	1397.505	1	H1-1b*
31	M120	PIPE2.0A21165	0.165	0	10	0.06	0		6	11550.536	23232.186	1397.505	1397.505	1	H1-1b*
32	M137	PIPE2.0A21165	0.165	0	10	0.06	0		6	11550.536	23232.186	1397.505	1397.505	1	H1-1b*
33	M136	PIPE2.0A21165	0.152	0	10	0.063	0		6	11550.536	23232.186	1397.505	1397.505	1	H1-1b*
34	M51	PIPE2.0A21165	0.152	0	10	0.063	0		6	11550.536	23232.186	1397.505	1397.505	1	H1-1b*
35	M117	PIPE2.0A21165	0.129	43.929	11	0.062	43.929		6	18200.463	23232.186	1397.505	1397.505	1	H1-1b
36	M139	PIPE2.0A21165	0.129	43.929	11	0.062	43.929		6	18200.463	23232.186	1397.505	1397.505	1	H1-1b
37	M131	PIPE2.0A21165	0.119	43.929	11	0.058	43.929		6	18200.463	23232.186	1397.505	1397.505	1	H1-1b
38	M119	PIPE2.0A21165	0.119	43.929	11	0.058	43.929		6	18200.463	23232.186	1397.505	1397.505	1	H1-1b
39	M134	PIPE2.0A21165	0.118	43.929	11	0.062	43.929		6	18200.463	23232.186	1397.505	1397.505	1	H1-1b
40	M128	PIPE2.0A21165	0.118	43.929	11	0.062	43.929		6	18200.463	23232.186	1397.505	1397.505	1	H1-1b
41	M122	PIPE2.0A21165	0.11	43.929	11	0.058	43.929		6	18200.463	23232.186	1397.505	1397.505	1	H1-1b
42	M141	PIPE2.0A21165	0.11	43.929	11	0.058	43.929		6	18200.463	23232.186	1397.505	1397.505	1	H1-1b
43	M144	PIPE2.0A21165	0.101	43.929	11	0.06	43.929		6	18200.463	23232.186	1397.505	1397.505	1	H1-1b
44	M50	PIPE2.0A21165	0.101	43.929	11	0.06	43.929		6	18200.463	23232.186	1397.505	1397.505	1	H1-1b
45	M113	PIPE2.0A21165	0.097	43.929	11	0.057	43.929		6	18200.463	23232.186	1397.505	1397.505	1	H1-1b*
46	M147	PIPE2.0A21165	0.097	43.929	11	0.057	43.929		6	18200.463	23232.186	1397.505	1397.505	1	H1-1b*
47	M125	PIPE2.0A21165	0.097	43.929	11	0.056	43.929		6	18200.463	23232.186	1397.505	1397.505	1	H1-1b*
48	M19	1.5X1.5X0.083	0.064	63.992	10	0.012	63.992	y	6	5774.53	14085.15	624.421	624.421	1.136	H1-1b*
49	M75B	1.5X1.5X0.083	0.064	64.142	10	0.012	64.142	y	6	5750.533	14085.15	624.421	624.421	1.136	H1-1b*

Envelope AA ADM1-15: ASD - BUILDING Member Aluminum Code Checks

Member	Shape	Code Check	Loc[in]	Lc	Shear Check	Loc[in]	Dir	Lc	Pnc/Om [lb]	Pnt/Om [lb]	Mny/Om [lb-ft]	Mnz/Om [lb-ft]	Vny/Om [lb]	Vnz/Om [lb]	Cb	Eqn	
1	M107	HR300 ALA	0.905	43.75	11	0.083	45.938	y	11	6230.805	14342.564	533.921	934.619	7307.692	3206.154	2.349	H.1-1
2	M35	HR300 ALA	0.905	43.75	11	0.083	45.938	y	11	6230.805	14342.564	533.921	934.619	7307.692	3206.154	2.349	H.1-1
3	M103	HR300 ALA	0.897	43.75	11	0.084	45.938	y	11	6230.805	14342.564	533.921	934.619	7307.692	3206.154	2.324	H.1-1
4	M29	HR300 ALA	0.897	43.75	11	0.084	45.938	y	11	6230.805	14342.564	533.921	934.619	7307.692	3206.154	2.324	H.1-1
5	M41	HR300 ALA	0.897	43.75	11	0.082	45.938	y	11	6230.805	14342.564	533.921	934.619	7307.692	3206.154	2.324	H.1-1
6	M95	HR300 ALA	0.897	43.75	11	0.082	45.938	y	11	6230.805	14342.564	533.921	934.619	7307.692	3206.154	2.324	H.1-1
7	M77	HR300 ALA	0.897	43.75	11	0.082	45.938	y	11	6230.805	14342.564	533.921	934.619	7307.692	3206.154	2.324	H.1-1
8	M60	HR300 ALA	0.897	43.75	11	0.082	45.938	y	11	6230.805	14342.564	533.921	934.619	7307.692	3206.154	2.324	H.1-1



Company : Vector Structural Engineering
 Designer : LKN
 Job Number : U2716.0366.231
 Model Name : Sunturf Ground Mount B7 SF 15°

2/7/2023
 12:07:54 PM
 Checked By : _____

Envelope AA ADM1-15: ASD - BUILDING Member Aluminum Code Checks (Continued)

Member	Shape	Code	Check	Loc[in]	Lc	Shear	Check	Loc[in]	Dir	Lc	Pnc/Om[lb]	Pnt/Om[lb]	Mny/Om[lb-ft]	Mnz/Om[lb-ft]	Vny/Om[lb]	Vnz/Om[lb]	Cb	Eqn
9	M85	HR300 ALA	0.897	43.75	11	0.083	45.938	y	11	6230.805	14342.564	533.921	934.619	7307.692	3206.154	2.324	H.1-1	
10	M54	HR300 ALA	0.897	43.75	11	0.083	45.938	y	11	6230.805	14342.564	533.921	934.619	7307.692	3206.154	2.324	H.1-1	
11	M47	HR300 ALA	0.897	43.75	11	0.083	45.938	y	11	6230.805	14342.564	533.921	934.619	7307.692	3206.154	2.324	H.1-1	
12	M89	HR300 ALA	0.897	43.75	11	0.083	45.938	y	11	6230.805	14342.564	533.921	934.619	7307.692	3206.154	2.324	H.1-1	
13	M32	HR300 ALA	0.897	43.75	11	0.083	164.063	y	10	6230.805	14342.564	533.921	934.619	7307.692	3206.154	2.324	H.1-1	
14	M101	HR300 ALA	0.897	43.75	11	0.083	164.063	y	10	6230.805	14342.564	533.921	934.619	7307.692	3206.154	2.324	H.1-1	
15	M38	HR300 ALA	0.897	43.75	11	0.083	45.938	y	11	6230.805	14342.564	533.921	934.619	7307.692	3206.154	2.324	H.1-1	
16	M97	HR300 ALA	0.897	43.75	11	0.083	45.938	y	11	6230.805	14342.564	533.921	934.619	7307.692	3206.154	2.324	H.1-1	
17	M66	HR300 ALA	0.897	43.75	11	0.082	45.938	y	11	6230.805	14342.564	533.921	934.619	7307.692	3206.154	2.324	H.1-1	
18	M63	HR300 ALA	0.897	43.75	11	0.082	45.938	y	11	6230.805	14342.564	533.921	934.619	7307.692	3206.154	2.324	H.1-1	
19	M57	HR300 ALA	0.897	43.75	11	0.082	45.938	y	11	6230.805	14342.564	533.921	934.619	7307.692	3206.154	2.324	H.1-1	
20	M83	HR300 ALA	0.897	43.75	11	0.082	45.938	y	11	6230.805	14342.564	533.921	934.619	7307.692	3206.154	2.324	H.1-1	
21	M91	HR300 ALA	0.897	43.75	11	0.082	45.938	y	11	6230.805	14342.564	533.921	934.619	7307.692	3206.154	2.324	H.1-1	
22	M44	HR300 ALA	0.897	43.75	11	0.082	45.938	y	11	6230.805	14342.564	533.921	934.619	7307.692	3206.154	2.324	H.1-1	
23	M16	HR300 ALA	0.889	43.75	11	0.081	164.063	y	10	6230.805	14342.564	533.921	934.619	7307.692	3206.154	2.349	H.1-1	
24	M109	HR300 ALA	0.888	43.75	11	0.081	164.063	y	10	6230.805	14342.564	533.921	934.619	7307.692	3206.154	2.349	H.1-1	

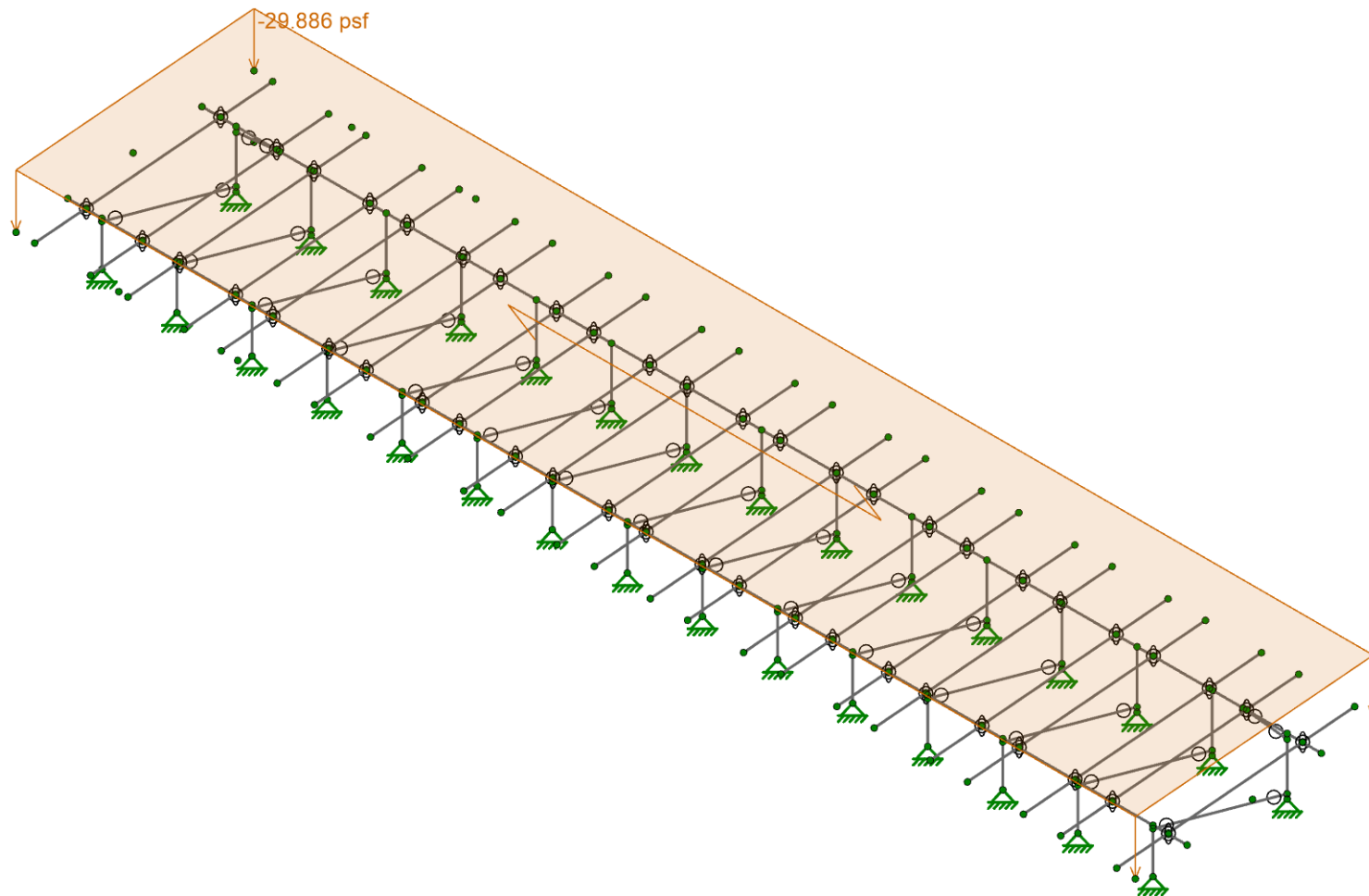
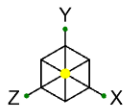

Loads: BLC 3, Roof Live/Snow

Vector Structural Engineering

LKN

U2716.0366.231

Sunturf Ground Mount B7 SF 5°

SK-1

Feb 02, 2023

Sunturf Ground Mount B7 82x42 5deg.r3d

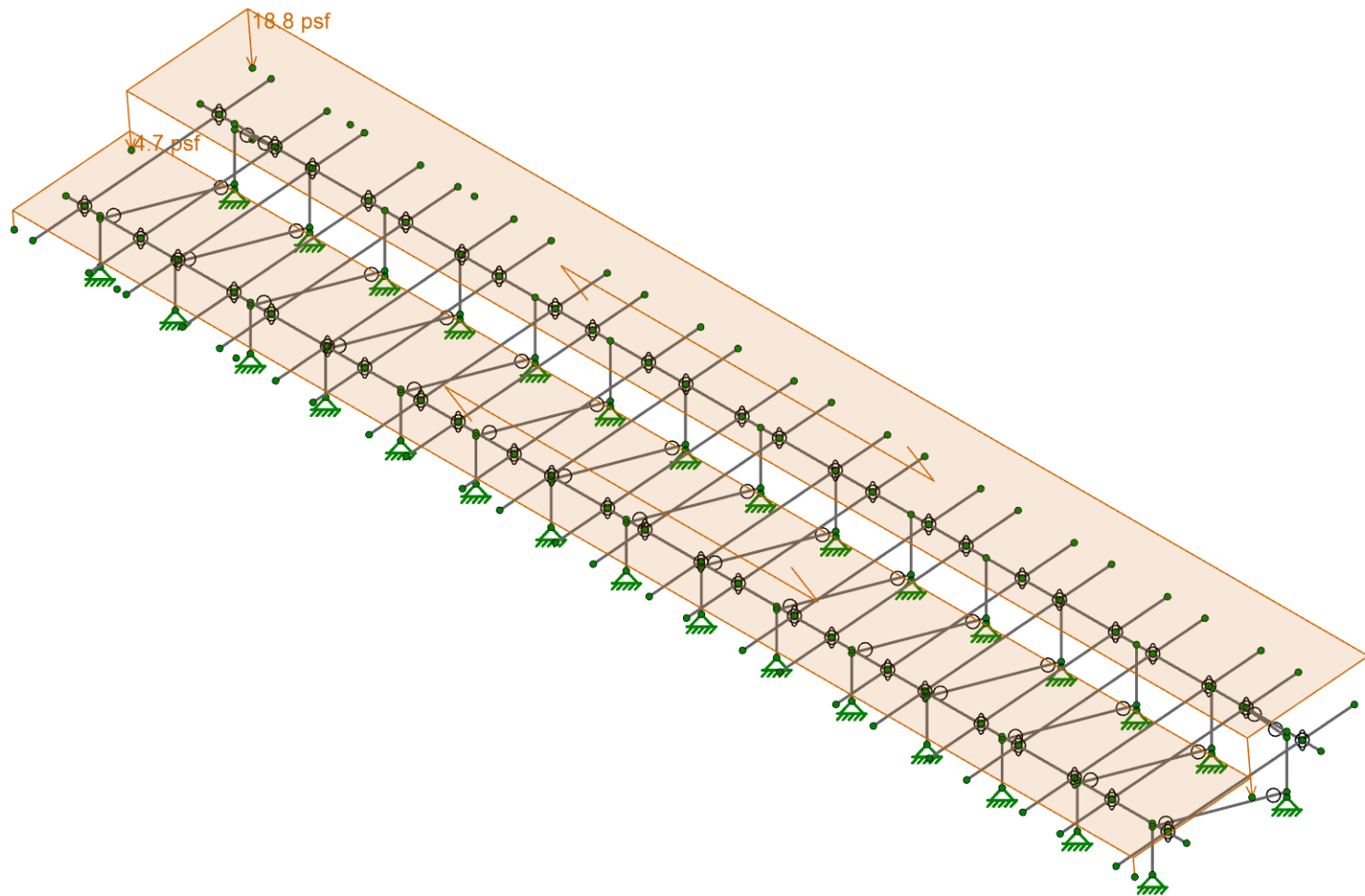
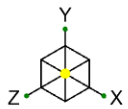

Loads: BLC 4, Wind A 0 deg

Vector Structural Engineering

LKN

U2716.0366.231

Sunturf Ground Mount B7 SF 5°

SK-2

Feb 02, 2023

Sunturf Ground Mount B7 82x42 5deg.r3d

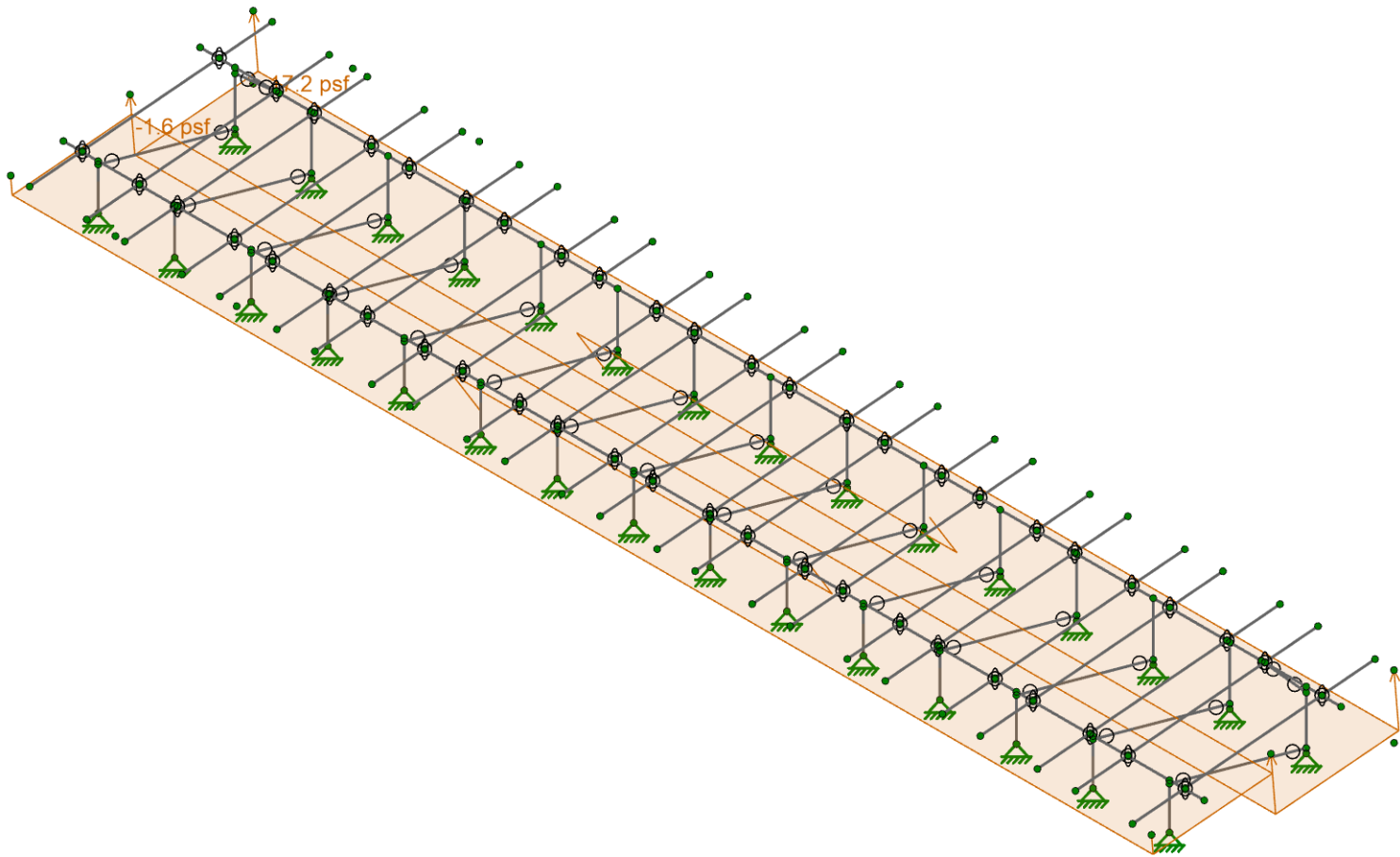
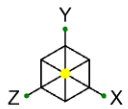

Loads: BLC 5, Wind B 0 deg

Vector Structural Engineering

LKN

U2716.0366.231

Sunturf Ground Mount B7 SF 5°

SK-3

Feb 02, 2023

Sunturf Ground Mount B7 82x42 5deg.r3d

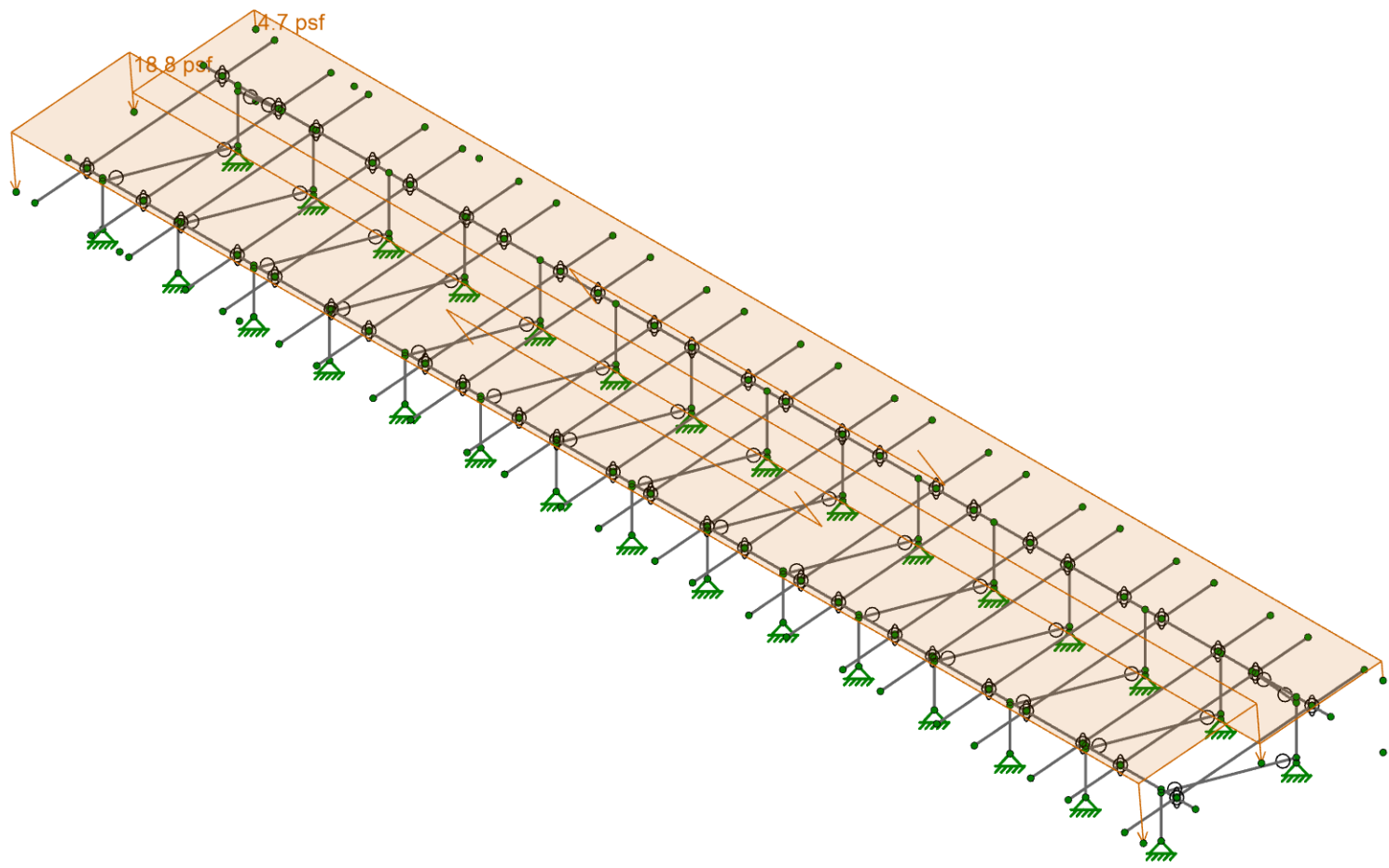
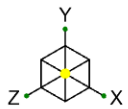

Loads: BLC 6, Wind A 180 deg

Vector Structural Engineering

LKN

U2716.0366.231

Sunturf Ground Mount B7 SF 5°

SK-4

Feb 02, 2023

Sunturf Ground Mount B7 82x42 5deg.r3d

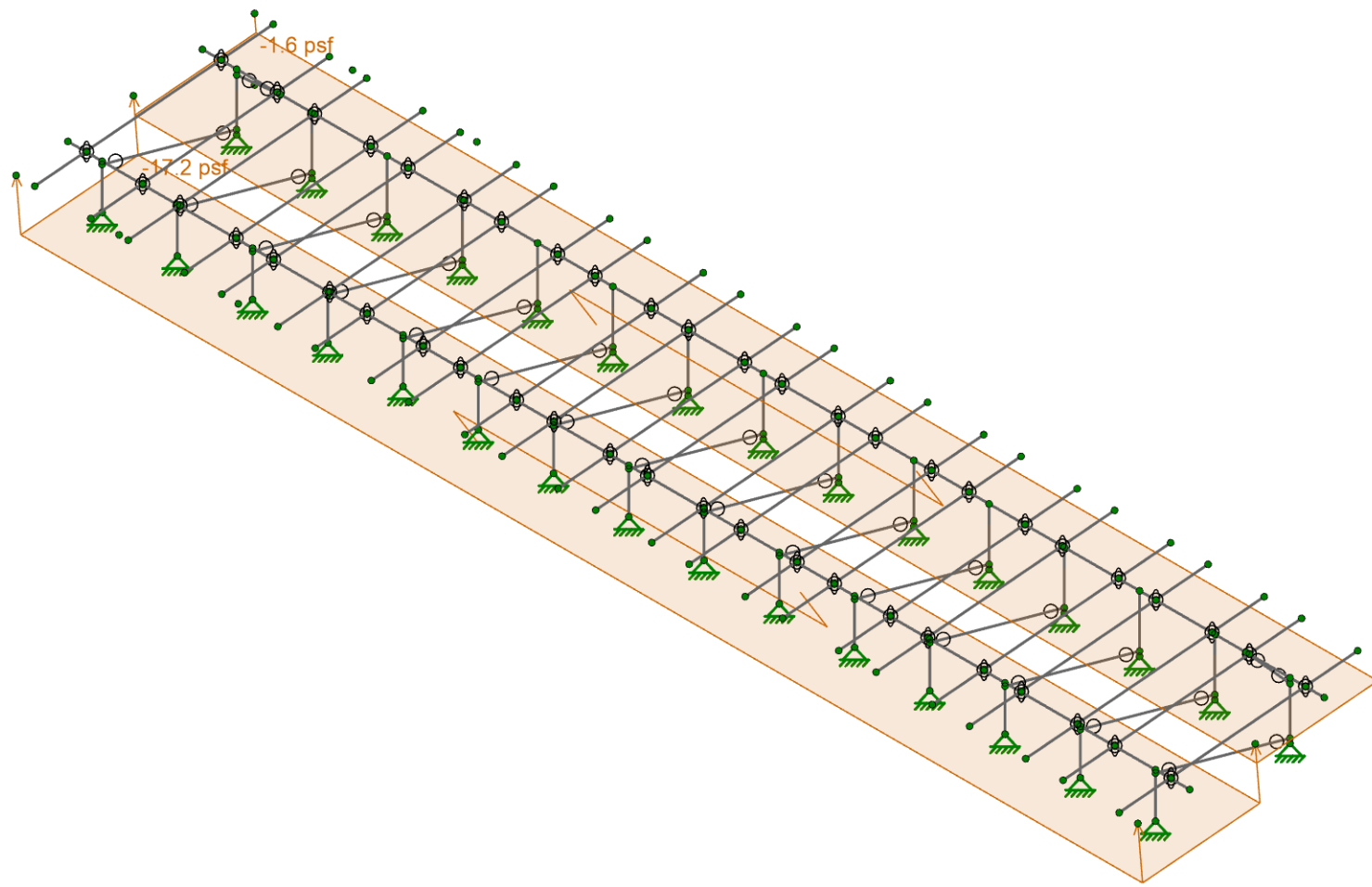
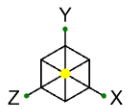

Loads: BLC 7, Wind B 180 deg

Vector Structural Engineering

LKN

U2716.0366.231

Sunturf Ground Mount B7 SF 5°

SK-5

Feb 02, 2023

Sunturf Ground Mount B7 82x42 5deg.r3d

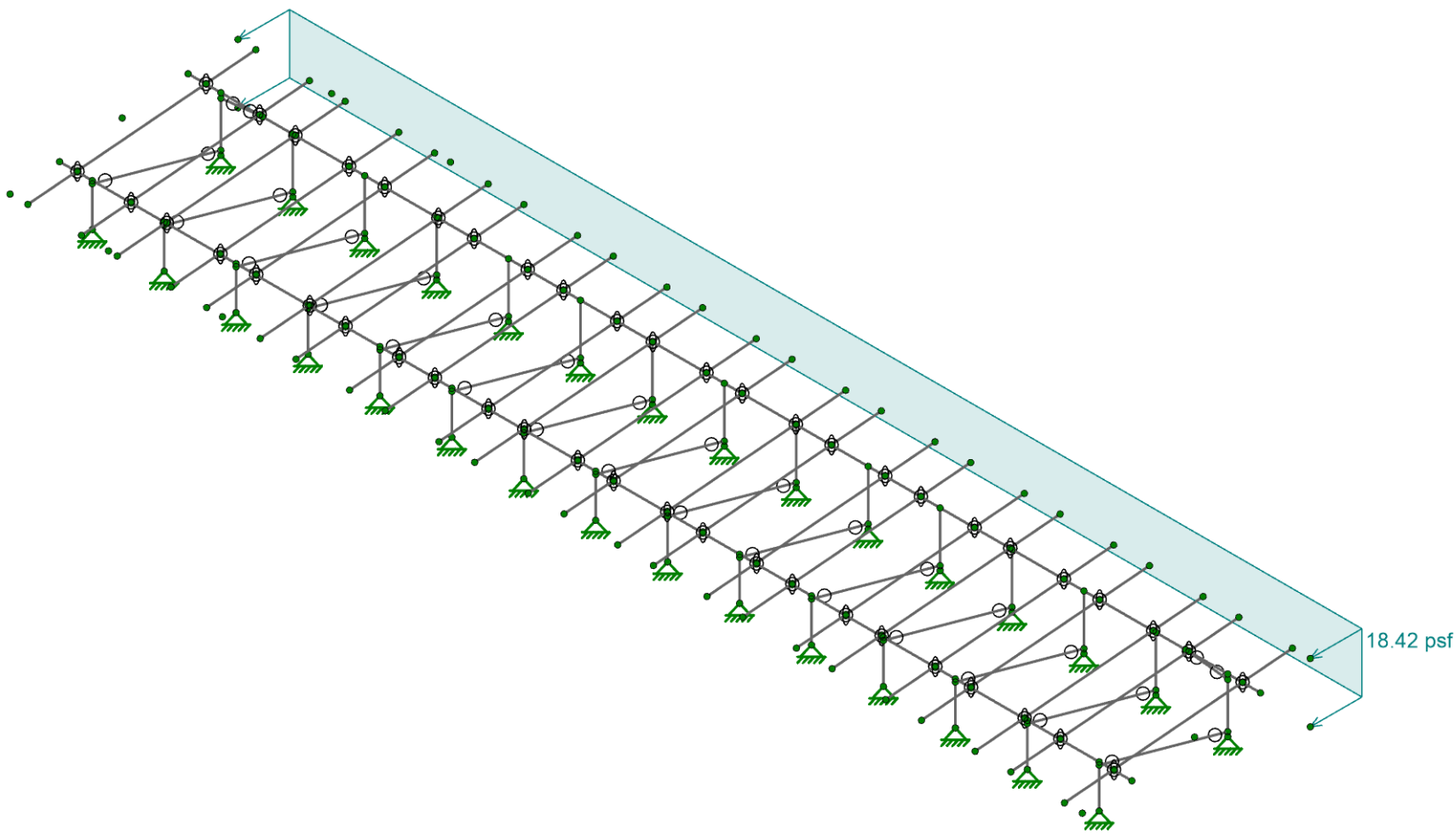
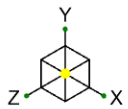

Loads: BLC 8, Wind Z

Vector Structural Engineering
LKN
U2716.0366.231

Sunturf Ground Mount B7 SF 5°

SK-6
Feb 02, 2023
Sunturf Ground Mount B7 82x42 5deg.r3d

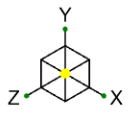

Code Check (Env)

- No Calc
- > 1.0
- .90-1.0
- .75-90
- .50-.75
- 0-.50

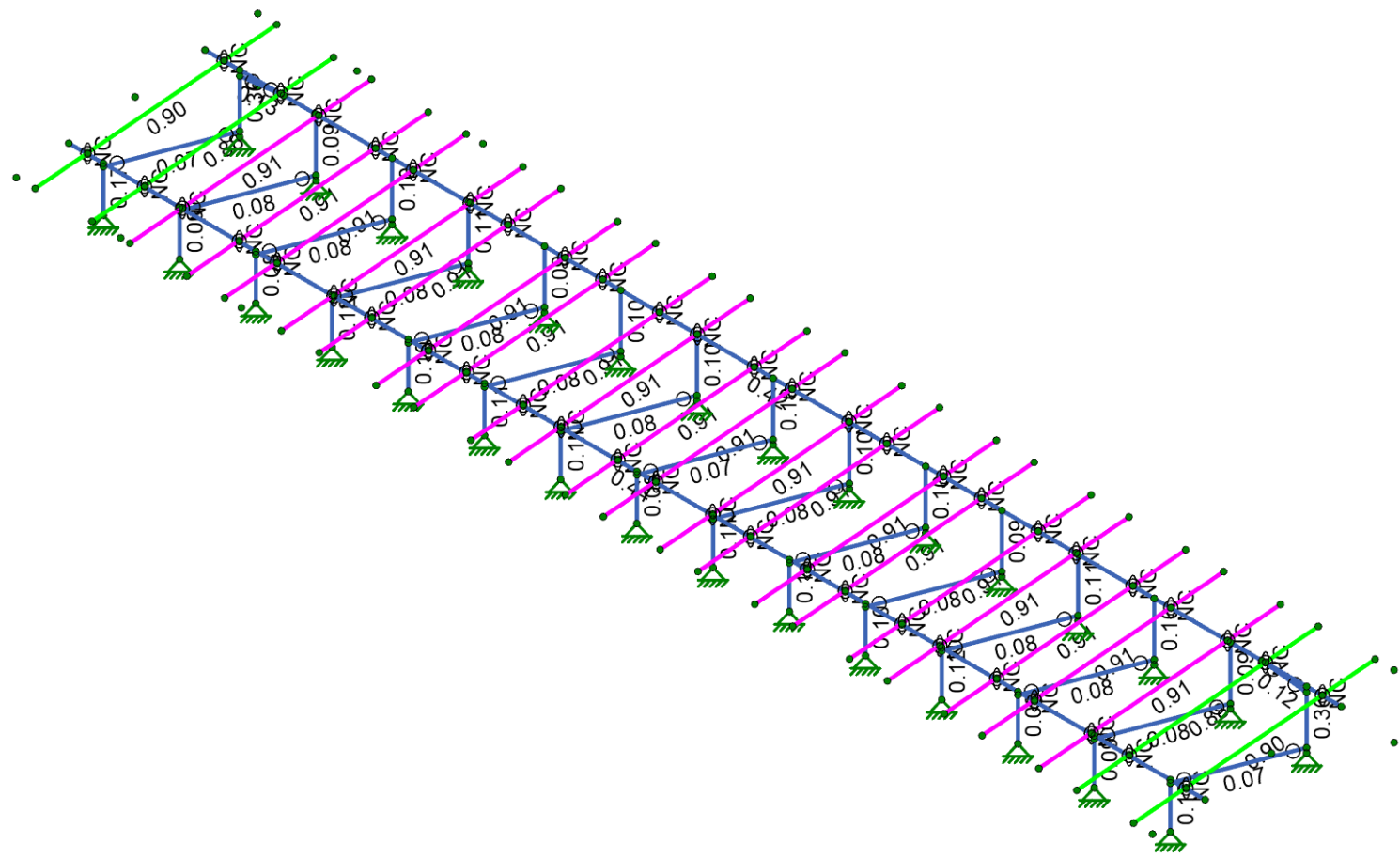

Member Code Checks Displayed (Enveloped)		
Vector Structural Engineering	Sunturf Ground Mount B7 SF 5°	SK-7
LKN		Feb 02, 2023
U2716.0366.231		Sunturf Ground Mount B7 82x42 5deg.r3d

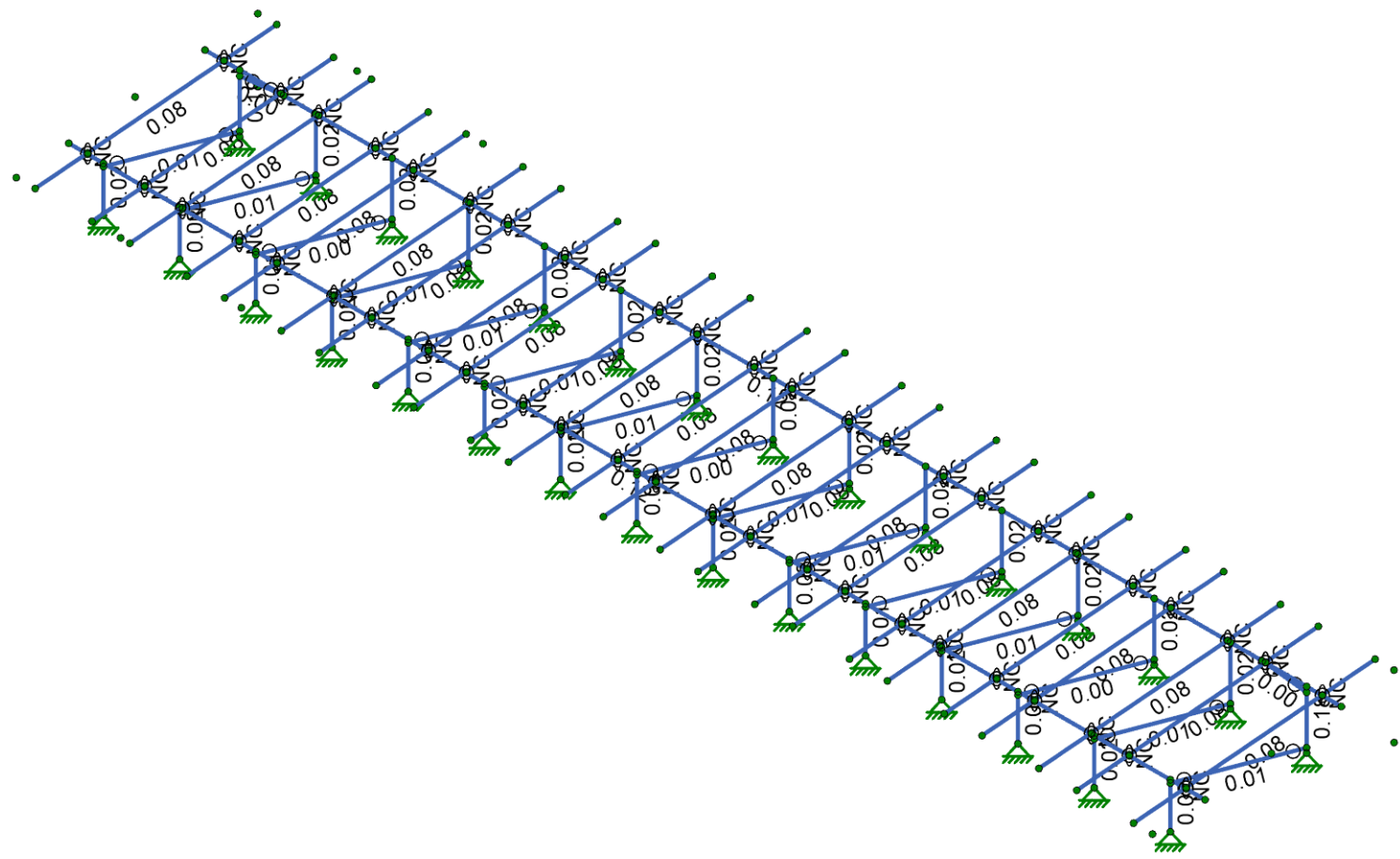
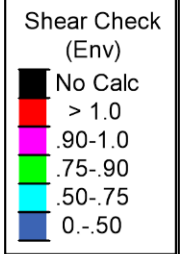
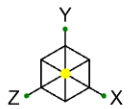

Member Shear Checks Displayed (Enveloped)	Sunturf Ground Mount B7 SF 5°	SK-8
Vector Structural Engineering		Feb 02, 2023
LKN		Sunturf Ground Mount B7 82x42 5deg.r3d
U2716.0366.231		

Basic Load Cases

	BLC Description	Category	Y Gravity	Distributed	Area(Member)
1	Self Weight	DL	-1.05		
2	Solar Panel Weight	DL			1
3	Roof Live/Snow	RLL			1
4	Wind A 0 deg	OL1			2
5	Wind B 0 deg	OL2			2
6	Wind A 180 deg	OL3			2
7	Wind B 180 deg	OL4			2
8	Wind Z	WLZ			1
9	BLC 2 Transient Area Loads	None		52	
10	BLC 3 Transient Area Loads	None		52	
11	BLC 4 Transient Area Loads	None		160	
12	BLC 5 Transient Area Loads	None		80	
13	BLC 6 Transient Area Loads	None		160	
14	BLC 7 Transient Area Loads	None		160	
15	BLC 8 Transient Area Loads	None		104	

Member Area Loads (BLC 2 : Solar Panel Weight)

	Node A	Node B	Node C	Node D	Direction	Load Direction	Magnitude [psf]
1	N197	N200	N199	N196	Y	A-B	-3

Member Area Loads (BLC 3 : Roof Live/Snow)

	Node A	Node B	Node C	Node D	Direction	Load Direction	Magnitude [psf]
1	N197	N200	N199	N196	PY	A-B	-30

Member Area Loads (BLC 4 : Wind A 0 deg)

	Node A	Node B	Node C	Node D	Direction	Load Direction	Magnitude [psf]
1	N197	N200	N201	N198	Perp	A-B	-14.1
2	N198	N201	N199	N196	Perp	A-B	-20.4

Member Area Loads (BLC 5 : Wind B 0 deg)

	Node A	Node B	Node C	Node D	Direction	Load Direction	Magnitude [psf]
1	N197	N200	N201	N198	Perp	A-B	-29.4
2	N198	N201	N199	N196	Perp	A-B	0

Member Area Loads (BLC 6 : Wind A 180 deg)

	Node A	Node B	Node C	Node D	Direction	Load Direction	Magnitude [psf]
1	N197	N200	N201	N198	Perp	A-B	25.1
2	N198	N201	N199	N196	Perp	A-B	20.4

Member Area Loads (BLC 7 : Wind B 180 deg)

	Node A	Node B	Node C	Node D	Direction	Load Direction	Magnitude [psf]
1	N197	N200	N201	N198	Perp	A-B	9.4
2	N198	N201	N199	N196	Perp	A-B	28.2



Company : Vector Structural Engineering
 Designer : LKN
 Job Number : U2716.0366.231
 Model Name : Sunturf Ground Mount B7 SF 15°

2/7/2023
 12:07:54 PM
 Checked By : _____

Member Area Loads (BLC 8 : Wind Z)

	Node A	Node B	Node C	Node D	Direction	Load Direction	Magnitude [psf]
1	N200	N197	N307	N308	Z	Open Structure	18.42

Load Combinations

	Description	Solve	P-Delta	BLC	Factor	BLC	Factor	BLC	Factor	BLC	Factor
1	ASD Loads		Y								
2	1.0 D	Yes	Y	DL	1						
3	1.0 D + 1.0 S	Yes	Y	DL	1	RLL	1				
4	1.0 D + 0.6 W1	Yes	Y	DL	1	RLL		OL1	0.6	WLZ	0.6
5	1.0 D + 0.6 W2	Yes	Y	DL	1	RLL		OL2	0.6	WLZ	0.6
6	1.0 D + 0.6 W3	Yes	Y	DL	1	RLL		OL3	0.6	WLZ	-0.6
7	1.0 D + 0.6 W4	Yes	Y	DL	1	RLL		OL4	0.6	WLZ	-0.6
8	1.0 D + 0.45 W1 + 0.75 S	Yes	Y	DL	1	RLL	0.75	OL1	0.45	WLZ	0.45
9	1.0 D + 0.45 W2 + 0.75 S	Yes	Y	DL	1	RLL	0.75	OL2	0.45	WLZ	0.45
10	1.0 D + 0.45 W3 + 0.75 S	Yes	Y	DL	1	RLL	0.75	OL3	0.45	WLZ	-0.45
11	1.0 D + 0.45 W4 + 0.75 S	Yes	Y	DL	1	RLL	0.75	OL4	0.45	WLZ	-0.45
12	0.6 D + 0.6 W1	Yes	Y	DL	0.6	RLL		OL1	0.6	WLZ	0.6
13	0.6 D + 0.6 W2	Yes	Y	DL	0.6	RLL		OL2	0.6	WLZ	0.6
14	0.6 D + 0.6 W3	Yes	Y	DL	0.6	RLL		OL3	0.6	WLZ	-0.6
15	0.6 D + 0.6 W4	Yes	Y	DL	0.6	RLL		OL4	0.6	WLZ	-0.6
16			Y								
17	LRFD Loads		Y								
18	1.4 D		Y	DL	1.4	RLL					
19	1.2 D + 1.6 S + 0.5 W1		Y	DL	1.2	RLL	1.6	OL1	0.5		
20	1.2 D + 1.6 S + 0.5 W2		Y	DL	1.2	RLL	1.6	OL2	0.5		
21	1.2 D + 1.6 S + 0.5 W3		Y	DL	1.2	RLL	1.6	OL3	0.5		
22	1.2 D + 1.6 S + 0.5 W4		Y	DL	1.2	RLL	1.6	OL4	0.5		
23	1.2 D + 1.0 W1		Y	DL	1.2	RLL		OL1	1		
24	1.2 D + 1.0 W2		Y	DL	1.2	RLL		OL2	1		
25	1.2 D + 1.0 W3		Y	DL	1.2	RLL		OL3	1		
26	1.2 D + 1.0 W4		Y	DL	1.2	RLL		OL4	1		
27	0.9 D + 1.0 W1		Y	DL	0.9	RLL		OL1	1		
28	0.9 D + 1.0 W2		Y	DL	0.9	RLL		OL2	1		
29	0.9 D + 1.0 W3		Y	DL	0.9	RLL		OL3	1		
30	0.9 D + 1.0 W4		Y	DL	0.9	RLL		OL4	1		

Envelope Node Reactions

	Node Label		X [lb]	LC	Y [lb]	LC	Z [lb]	LC	MX [lb-ft]	LC	MY [lb-ft]	LC	MZ [lb-ft]	LC
1	N2	max	8.939	12	1596.042	11	13.881	4	0	15	0	15	0	15
2		min	-44.303	11	-258.882	12	-19.629	6	0	2	0	2	0	2
3	N1	max	90.783	10	2009.234	10	404.513	6	0	15	0	15	0	15
4		min	-41.784	13	-839.156	13	-319.72	4	0	2	0	2	0	2
5	N109	max	0.329	9	1752.225	10	429.058	6	0	15	0	15	0	15
6		min	-0.155	6	-755.514	13	-336.142	4	0	2	0	2	0	2
7	N110A	max	4.192	12	1679.591	11	14.403	4	0	15	0	15	0	15
8		min	-13.933	11	-283.293	12	-20.516	6	0	2	0	2	0	2
9	N151	max	41.813	13	2008.938	10	404.422	6	0	15	0	15	0	15
10		min	-90.811	10	-838.906	13	-319.65	4	0	2	0	2	0	2
11	N152	max	44.268	11	1595.877	11	13.879	4	0	15	0	15	0	15
12		min	-8.907	12	-258.741	12	-19.626	6	0	2	0	2	0	2
13	N237	max	0.392	13	1959.392	10	406.765	6	0	15	0	15	0	15
14		min	-0.872	10	-821.685	13	-323.076	4	0	2	0	2	0	2
15	N239	max	1.464	11	1696.588	11	14.228	4	0	15	0	15	0	15



Envelope Node Reactions (Continued)

Node Label		X [lb]	LC	Y [lb]	LC	Z [lb]	LC	MX [lb-ft]	LC	MY [lb-ft]	LC	MZ [lb-ft]	LC	
16		min	-0.603	12	-288.049	12	-20.164	6	0	2	0	2	0	2
17	N244	max	10.976	10	1951.483	10	441.197	6	0	15	0	15	0	15
18		min	-4.291	13	-836.344	13	-345.105	4	0	2	0	2	0	2
19	N246	max	25.97	11	1692.365	11	14.74	4	0	15	0	15	0	15
20		min	-6.407	12	-275.567	12	-20.942	6	0	2	0	2	0	2
21	N250	max	5.012	12	1655.108	11	14.276	4	0	15	0	15	0	15
22		min	-22.224	11	-275.98	12	-20.245	6	0	2	0	2	0	2
23	N253	max	7.903	10	1903.469	10	411.288	6	0	15	0	15	0	15
24		min	-3.293	13	-801.329	13	-325.567	4	0	2	0	2	0	2
25	N255	max	18.246	11	1649.243	11	14.203	4	0	15	0	15	0	15
26		min	-4.102	12	-276.082	12	-20.134	6	0	2	0	2	0	2
27	N257	max	4.102	13	1909.342	10	415.34	6	0	15	0	15	0	15
28		min	-9.797	10	-805.995	13	-328.169	4	0	2	0	2	0	2
29	N260	max	9.795	10	1909.349	10	415.342	6	0	15	0	15	0	15
30		min	-4.103	13	-805.999	13	-328.171	4	0	2	0	2	0	2
31	N264	max	21.368	11	1695.7	11	14.748	4	0	15	0	15	0	15
32		min	-5.439	12	-276.693	12	-20.945	6	0	2	0	2	0	2
33	N267	max	22.227	11	1655.105	11	14.276	4	0	15	0	15	0	15
34		min	-5.015	12	-275.979	12	-20.245	6	0	2	0	2	0	2
35	N268	max	0.002	7	1691.791	11	14.284	4	0	15	0	15	0	15
36		min	-0.002	12	-288.915	12	-20.234	6	0	2	0	2	0	2
37	N271	max	3.393	13	1958.827	10	439.759	6	0	15	0	15	0	15
38		min	-8.748	10	-838.358	13	-344.292	4	0	2	0	2	0	2
39	N273	max	5.436	12	1695.699	11	14.747	4	0	15	0	15	0	15
40		min	-21.364	11	-276.694	12	-20.945	6	0	2	0	2	0	2
41	N275	max	0	15	1925.365	10	404.768	6	0	15	0	15	0	15
42		min	-0.001	10	-808.154	13	-321.396	4	0	2	0	2	0	2
43	N281	max	8.745	10	1958.816	10	439.762	6	0	15	0	15	0	15
44		min	-3.393	13	-838.354	13	-344.294	4	0	2	0	2	0	2
45	N286	max	0.602	12	1696.582	11	14.228	4	0	15	0	15	0	15
46		min	-1.462	11	-288.039	12	-20.164	6	0	2	0	2	0	2
47	N289	max	6.404	12	1692.368	11	14.74	4	0	15	0	15	0	15
48		min	-25.966	11	-275.572	12	-20.942	6	0	2	0	2	0	2
49	N293	max	0.188	6	1752.828	10	429.151	6	0	15	0	15	0	15
50		min	-0.321	9	-755.906	13	-336.217	4	0	2	0	2	0	2
51	N297	max	13.951	11	1679.654	11	14.405	4	0	15	0	15	0	15
52		min	-4.209	12	-283.377	12	-20.518	6	0	2	0	2	0	2
53	N298	max	3.293	13	1903.462	10	411.295	6	0	15	0	15	0	15
54		min	-7.907	10	-801.326	13	-325.571	4	0	2	0	2	0	2
55	N299	max	4.099	12	1649.241	11	14.203	4	0	15	0	15	0	15
56		min	-18.243	11	-276.079	12	-20.134	6	0	2	0	2	0	2
57	N301	max	4.289	13	1951.534	10	441.191	6	0	15	0	15	0	15
58		min	-10.976	10	-836.371	13	-345.103	4	0	2	0	2	0	2
59	N306	max	0.858	10	1959.145	10	406.743	6	0	15	0	15	0	15
60		min	-0.387	13	-821.549	13	-323.057	4	0	2	0	2	0	2
61	Totals:	max	0.001	13	51361.859	10	5995.211	6						
62		min	-0.001	10	-10728.094	12	-4750.292	12						

Envelope AISC 15TH (360-16): ASD Member Steel Code Checks

Member	Shape	Code Check	Loc[in]	LC	Shear Check	Loc[in]	Dir	LC	Pnc/om [lb]	Pnt/om [lb]	Mnny/om [lb-ft]	Mnzz/om [lb-ft]	Cb	Eqn
1	M72	PIPE2.5A21168	0.489	30.75	11	0.132	358.75	11	20336.2	28358.413	2081.747	2081.747	1	H1-1b
2	M71	PIPE2.5A21168	0.454	358.75	10	0.135	625.25	10	20336.2	28358.413	2081.747	2081.747	1	H1-1b
3	M116	1.5X1.5X0.083	0.347	63.562	6	0.009	124.529	y 10	1531.167	14085.15	624.421	624.421	1.136	H1-1a
4	M138	1.5X1.5X0.083	0.347	63.562	6	0.009	124.529	y 10	1531.167	14085.15	624.421	624.421	1.136	H1-1a
5	M133	1.5X1.5X0.083	0.346	63.562	6	0.008	124.529	y 10	1531.167	14085.15	624.421	624.421	1.136	H1-1a

Envelope AISC 15TH (360-16): ASD Member Steel Code Checks (Continued)

Member	Shape	Code Check	Loc[in]	Lc	Shear Check	Loc[in]	Dir	Lc	Pnc/om [lb]	Pnt/om [lb]	Mny/om [lb-ft]	Mnz/om [lb-ft]	Cb	Eqn	
6	M127	1.5X1.5X0.083	0.346	63.562	6	0.008	124.529	y	10	1531.167	14085.15	624.421	624.421	1.136	H1-1a
7	M143	1.5X1.5X0.083	0.338	63.562	6	0.004	124.529	y	11	1531.167	14085.15	624.421	624.421	1.136	H1-1a
8	M52	1.5X1.5X0.083	0.338	63.562	6	0.004	124.529	y	11	1531.167	14085.15	624.421	624.421	1.136	H1-1a
9	M130	1.5X1.5X0.083	0.327	63.562	6	0.008	124.529	y	3	1531.167	14085.15	624.421	624.421	1.136	H1-1a
10	M118	1.5X1.5X0.083	0.327	63.562	6	0.008	124.529	y	3	1531.167	14085.15	624.421	624.421	1.136	H1-1a
11	M140	1.5X1.5X0.083	0.324	63.562	6	0.007	124.529	y	3	1531.167	14085.15	624.421	624.421	1.136	H1-1a
12	M121	1.5X1.5X0.083	0.324	63.562	6	0.007	124.529	y	3	1531.167	14085.15	624.421	624.421	1.136	H1-1a
13	M112	1.5X1.5X0.083	0.321	63.562	6	0.002	124.529	y	8	1531.167	14085.15	624.421	624.421	1.136	H1-1a
14	M146	1.5X1.5X0.083	0.321	63.562	6	0.002	124.529	y	8	1531.167	14085.15	624.421	624.421	1.136	H1-1a
15	M124	1.5X1.5X0.083	0.32	63.562	6	0.002	124.529	y	10	1531.167	14085.15	624.421	624.421	1.136	H1-1a
16	M15	1.5X1.5X0.083	0.319	63.562	6	0.007	124.529	y	5	1531.161	14085.15	624.421	624.421	1.136	H1-1a
17	M75	1.5X1.5X0.083	0.319	63.562	6	0.007	124.529	y	5	1531.167	14085.15	624.421	624.421	1.136	H1-1a
18	M6	PIPE2.0A21165	0.316	78.413	10	0.06	0		6	11550.536	23232.186	1397.505	1397.505	1	H1-1b
19	M74	PIPE2.0A21165	0.315	78.413	10	0.06	0		6	11550.536	23232.186	1397.505	1397.505	1	H1-1b
20	M114	PIPE2.0A21165	0.17	0	10	0.06	0		6	11550.536	23232.186	1397.505	1397.505	1	H1-1b*
21	M145	PIPE2.0A21165	0.17	0	10	0.06	0		6	11550.536	23232.186	1397.505	1397.505	1	H1-1b*
22	M126	PIPE2.0A21165	0.17	0	10	0.064	0		6	11550.536	23232.186	1397.505	1397.505	1	H1-1b*
23	M132	PIPE2.0A21165	0.17	0	10	0.064	0		6	11550.536	23232.186	1397.505	1397.505	1	H1-1b*
24	M142	PIPE2.0A21165	0.169	0	10	0.065	0		6	11550.536	23232.186	1397.505	1397.505	1	H1-1b*
25	M115	PIPE2.0A21165	0.169	0	10	0.065	0		6	11550.536	23232.186	1397.505	1397.505	1	H1-1b*
26	M5	PIPE2.0A21165	0.168	43.929	11	0.057	43.929		6	18200.463	23232.186	1397.505	1397.505	1	H1-1b
27	M73	PIPE2.0A21165	0.168	43.929	11	0.057	43.929		6	18200.463	23232.186	1397.505	1397.505	1	H1-1b
28	M129	PIPE2.0A21165	0.167	0	10	0.059	0		6	11550.536	23232.186	1397.505	1397.505	1	H1-1b*
29	M135	PIPE2.0A21165	0.165	0	10	0.061	0		6	11550.536	23232.186	1397.505	1397.505	1	H1-1b*
30	M123	PIPE2.0A21165	0.165	0	10	0.061	0		6	11550.536	23232.186	1397.505	1397.505	1	H1-1b*
31	M120	PIPE2.0A21165	0.165	0	10	0.06	0		6	11550.536	23232.186	1397.505	1397.505	1	H1-1b*
32	M137	PIPE2.0A21165	0.165	0	10	0.06	0		6	11550.536	23232.186	1397.505	1397.505	1	H1-1b*
33	M136	PIPE2.0A21165	0.152	0	10	0.063	0		6	11550.536	23232.186	1397.505	1397.505	1	H1-1b*
34	M51	PIPE2.0A21165	0.152	0	10	0.063	0		6	11550.536	23232.186	1397.505	1397.505	1	H1-1b*
35	M117	PIPE2.0A21165	0.129	43.929	11	0.062	43.929		6	18200.463	23232.186	1397.505	1397.505	1	H1-1b
36	M139	PIPE2.0A21165	0.129	43.929	11	0.062	43.929		6	18200.463	23232.186	1397.505	1397.505	1	H1-1b
37	M131	PIPE2.0A21165	0.119	43.929	11	0.058	43.929		6	18200.463	23232.186	1397.505	1397.505	1	H1-1b
38	M119	PIPE2.0A21165	0.119	43.929	11	0.058	43.929		6	18200.463	23232.186	1397.505	1397.505	1	H1-1b
39	M134	PIPE2.0A21165	0.118	43.929	11	0.062	43.929		6	18200.463	23232.186	1397.505	1397.505	1	H1-1b
40	M128	PIPE2.0A21165	0.118	43.929	11	0.062	43.929		6	18200.463	23232.186	1397.505	1397.505	1	H1-1b
41	M122	PIPE2.0A21165	0.11	43.929	11	0.058	43.929		6	18200.463	23232.186	1397.505	1397.505	1	H1-1b
42	M141	PIPE2.0A21165	0.11	43.929	11	0.058	43.929		6	18200.463	23232.186	1397.505	1397.505	1	H1-1b
43	M144	PIPE2.0A21165	0.101	43.929	11	0.06	43.929		6	18200.463	23232.186	1397.505	1397.505	1	H1-1b
44	M50	PIPE2.0A21165	0.101	43.929	11	0.06	43.929		6	18200.463	23232.186	1397.505	1397.505	1	H1-1b
45	M113	PIPE2.0A21165	0.097	43.929	11	0.057	43.929		6	18200.463	23232.186	1397.505	1397.505	1	H1-1b*
46	M147	PIPE2.0A21165	0.097	43.929	11	0.057	43.929		6	18200.463	23232.186	1397.505	1397.505	1	H1-1b*
47	M125	PIPE2.0A21165	0.097	43.929	11	0.056	43.929		6	18200.463	23232.186	1397.505	1397.505	1	H1-1b*
48	M19	1.5X1.5X0.083	0.064	63.992	10	0.012	63.992	y	6	5774.53	14085.15	624.421	624.421	1.136	H1-1b*
49	M75B	1.5X1.5X0.083	0.064	64.142	10	0.012	64.142	y	6	5750.533	14085.15	624.421	624.421	1.136	H1-1b*

Envelope AA ADM1-15: ASD - BUILDING Member Aluminum Code Checks

Member	Shape	Code Check	Loc[in]	Lc	Shear Check	Loc[in]	Dir	Lc	Pnc/Om [lb]	Pnt/Om [lb]	Mny/Om [lb-ft]	Mnz/Om [lb-ft]	Vny/Om [lb]	Vnz/Om [lb]	Cb	Eqn	
1	M107	HR300 ALA	0.905	43.75	11	0.083	45.938	y	11	6230.805	14342.564	533.921	934.619	7307.692	3206.154	2.349	H.1-1
2	M35	HR300 ALA	0.905	43.75	11	0.083	45.938	y	11	6230.805	14342.564	533.921	934.619	7307.692	3206.154	2.349	H.1-1
3	M103	HR300 ALA	0.897	43.75	11	0.084	45.938	y	11	6230.805	14342.564	533.921	934.619	7307.692	3206.154	2.324	H.1-1
4	M29	HR300 ALA	0.897	43.75	11	0.084	45.938	y	11	6230.805	14342.564	533.921	934.619	7307.692	3206.154	2.324	H.1-1
5	M41	HR300 ALA	0.897	43.75	11	0.082	45.938	y	11	6230.805	14342.564	533.921	934.619	7307.692	3206.154	2.324	H.1-1
6	M95	HR300 ALA	0.897	43.75	11	0.082	45.938	y	11	6230.805	14342.564	533.921	934.619	7307.692	3206.154	2.324	H.1-1
7	M77	HR300 ALA	0.897	43.75	11	0.082	45.938	y	11	6230.805	14342.564	533.921	934.619	7307.692	3206.154	2.324	H.1-1
8	M60	HR300 ALA	0.897	43.75	11	0.082	45.938	y	11	6230.805	14342.564	533.921	934.619	7307.692	3206.154	2.324	H.1-1



Envelope AA ADM1-15: ASD - BUILDING Member Aluminum Code Checks (Continued)

Member	Shape	Code	Check	Loc[in]	Lc	Shear	Check	Loc[in]	Dir	Lc	Pnc/Om[lb]	Pnt/Om[lb]	Mny/Om[lb-ft]	Mnz/Om[lb-ft]	Vny/Om[lb]	Vnz/Om[lb]	Cb	Eqn
9	M85	HR300	ALA	0.897	43.75	11	0.083	45.938	y	11	6230.805	14342.564	533.921	934.619	7307.692	3206.154	2.324	H.1-1
10	M54	HR300	ALA	0.897	43.75	11	0.083	45.938	y	11	6230.805	14342.564	533.921	934.619	7307.692	3206.154	2.324	H.1-1
11	M47	HR300	ALA	0.897	43.75	11	0.083	45.938	y	11	6230.805	14342.564	533.921	934.619	7307.692	3206.154	2.324	H.1-1
12	M89	HR300	ALA	0.897	43.75	11	0.083	45.938	y	11	6230.805	14342.564	533.921	934.619	7307.692	3206.154	2.324	H.1-1
13	M32	HR300	ALA	0.897	43.75	11	0.083	164.063	y	10	6230.805	14342.564	533.921	934.619	7307.692	3206.154	2.324	H.1-1
14	M101	HR300	ALA	0.897	43.75	11	0.083	164.063	y	10	6230.805	14342.564	533.921	934.619	7307.692	3206.154	2.324	H.1-1
15	M38	HR300	ALA	0.897	43.75	11	0.083	45.938	y	11	6230.805	14342.564	533.921	934.619	7307.692	3206.154	2.324	H.1-1
16	M97	HR300	ALA	0.897	43.75	11	0.083	45.938	y	11	6230.805	14342.564	533.921	934.619	7307.692	3206.154	2.324	H.1-1
17	M66	HR300	ALA	0.897	43.75	11	0.082	45.938	y	11	6230.805	14342.564	533.921	934.619	7307.692	3206.154	2.324	H.1-1
18	M63	HR300	ALA	0.897	43.75	11	0.082	45.938	y	11	6230.805	14342.564	533.921	934.619	7307.692	3206.154	2.324	H.1-1
19	M57	HR300	ALA	0.897	43.75	11	0.082	45.938	y	11	6230.805	14342.564	533.921	934.619	7307.692	3206.154	2.324	H.1-1
20	M83	HR300	ALA	0.897	43.75	11	0.082	45.938	y	11	6230.805	14342.564	533.921	934.619	7307.692	3206.154	2.324	H.1-1
21	M91	HR300	ALA	0.897	43.75	11	0.082	45.938	y	11	6230.805	14342.564	533.921	934.619	7307.692	3206.154	2.324	H.1-1
22	M44	HR300	ALA	0.897	43.75	11	0.082	45.938	y	11	6230.805	14342.564	533.921	934.619	7307.692	3206.154	2.324	H.1-1
23	M16	HR300	ALA	0.889	43.75	11	0.081	164.063	y	10	6230.805	14342.564	533.921	934.619	7307.692	3206.154	2.349	H.1-1
24	M109	HR300	ALA	0.888	43.75	11	0.081	164.063	y	10	6230.805	14342.564	533.921	934.619	7307.692	3206.154	2.349	H.1-1



JOB NO.: U2716.0366.231

PROJECT: Sunturf Package B7

SUBJECT: CALCULATIONS

DESIGN APPROACH ASD

CONNECTION CAPACITY

Location: Column Base (set screws)

Connection Type: M16 Conical Set Screws

Tensile Capacity: 2603 lbs (AISC Equation J3-1)

Tension Load: 1560 lbs

Check Connection: 59.9%

Result: **Select M16 Conical Set Screws**

Note: Uplift capacity. FOS of (2)

CONNECTION CAPACITY

Location: Column to Cross Beam

Connection Type: K10341-002

Tensile Capacity: 2195 lbs

Tension Load: 1195 lbs

Check Connection: 54.4%

Result: **Select K10341-002**

Note: Uplift capacity. FOS of (2)



JOB NO.: U2716.0366.231

PROJECT: Sunturf Package B7

SUBJECT: CALCULATIONS

CONNECTION CAPACITY

Location: Brace to Column

Connection Type: K10219-001

Capacity: 1335 lbs (AISC Equation J3-1)

Tension Load: 1269 lbs

Check Connection: 95.1%

Result: **Select K10219-001**

Note: Axial capacity. FOS of (2)

BOLTED TENSION CONNECTION

Location: Rail to Cross Beam

Bolt Grade: A304 SS (A2-70)

Bolt Diameter: 0.375 in

Number of Bolts: 2

Bolt Capacity: 8410 lbs (AISC Equation J3-1)

Tension Load: 798 lbs

Check Bolt: 9.5%

Result: **Select (2) 0.375 in. dia. A304 SS (A2-70) bolts.**

Note:



PROJECT: Sunturf Package B7 Ground Mount

DRILLED CONCRETE PIER DESIGN

Column Reactions:

Max. Shear, V [k]:	1.1	Max. Down, P _d [k]:	2.2
Max. Moment, M [k-ft]:	0.0	Max. Uplift, P _u [k]:	1.6

Pier Properties:

Pier Shape:	Round	Volume of Concrete [ft ³]:	8
Pier Diameter, b [ft]:	1.5	Volume of Concrete [yd ³]:	0.3
Top of Pier Elevation [ft]:	0.00	Weight of Concrete [k]:	1.2
Pier Depth, d [ft]:	4.5		

Soil Properties:

Allow. Bearing Pressure [psf]:	1,500
1/3 increase for short term loads?	No
Lateral Bearing, S [pcf]:	150
Max. Lateral Bearing (opt'l) [psf]:	
Top Depth to Ignore [ft]:	0
1/3 increase for short term loads?	No
1/2" deflection at t/o pier allowed:	Yes

Optional Parameters for Uplift:

Skin Friction* [psf]:	250
Top Length to Ignore [ft]:	0
1/3 increase for short term loads?	No
Combine w/ Bearing:	No

*per IBC Section 1810.3.3.1.4

Check Bearing:

Bearing Capacity [k]:	5.3
-----------------------	-----

Bearing capacity OK.

Check Uplift:

Uplift Capacity [k]:	6.4
----------------------	-----

Uplift capacity OK.

Check Lateral Bearing:

Top of Pier Constrained?:	No
Applied Lateral Force, P [lb]:	1,123
Point of Application, h [ft]:	0.0
S _{max} [psf]:	
S [psf]:	450
A = 2.34*P/(Sb):	3.89
Required Pier Depth, d _{reqd} [ft]:	3.90

IBC Section 1807.3.2.1

IBC Eq. 18-1

Result: **Lateral bearing capacity OK.**



Vector Structural Engineeri..	Ground Mount	SK - 1
LKN		Feb 2, 2023 at 5:22 PM
U2716.0366.231		Sunturf Ground Mount B7 LF 30de...

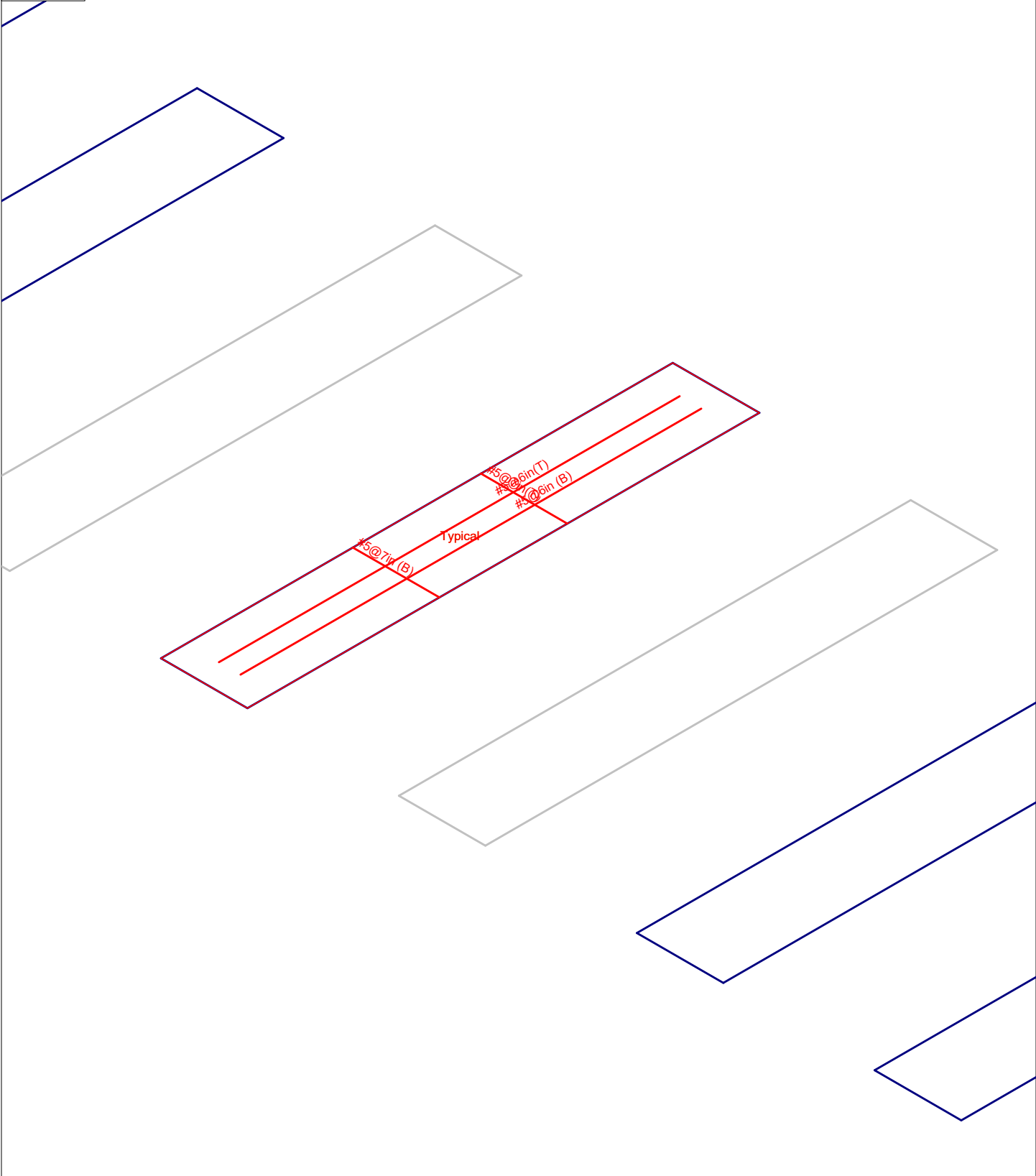
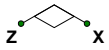

Results for LC 2, 1.0 D

Vector Structural Engineeri...	Ground Mount	SK - 1
LKN		Feb 2, 2023 at 5:23 PM
U2716.0366.231		Sunturf Ground Mount B7 LF 30de...

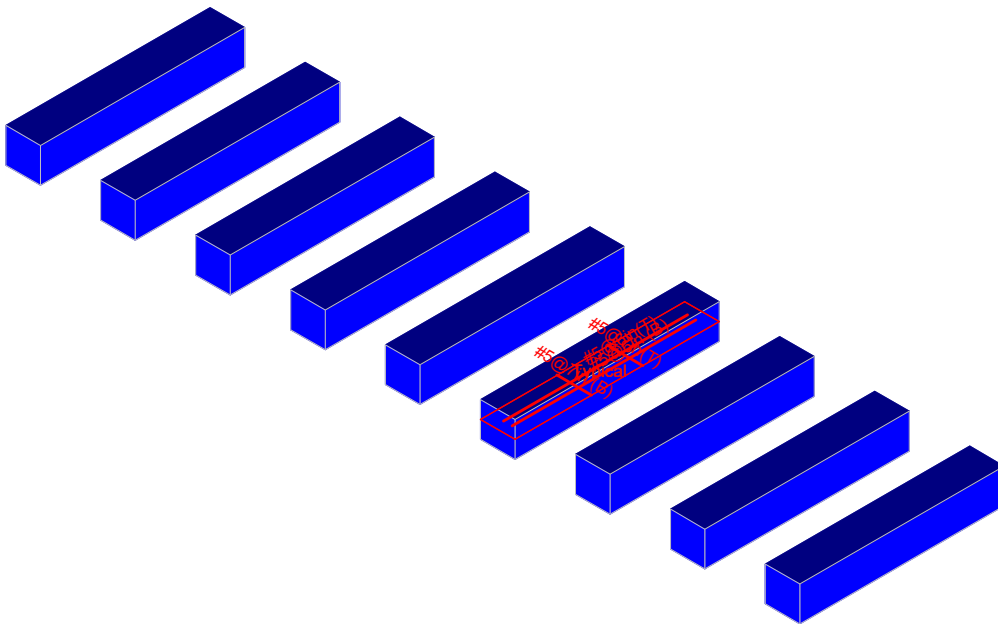
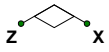

Results for LC 2, 1.0 D

Vector Structural Engineeri...
LKN
U2716.0366.231

Ground Mount

SK - 2

Feb 2, 2023 at 5:23 PM

Sunturf Ground Mount B7 LF 30de...

(Global) Model Settings

Display Sections for Member Calcs	5
Max Internal Sections for Member Calcs	100
Mesh Size (in)	12
Max Iterations	10
Merge Tolerance (in)	0.12
Solver	Sparse Accelerated
Coefficient of Friction	0.3
No. of Shear Regions	4
Shear Region Spacing Increment (in)	4
Min 1 Bar Dia Spacing for Beams?	No
Optimize footings for OTM / Sliding?	Yes
Parme Beta Factor	0.65
Pile Safety Factor	3
Min % Steel for Pedestal	Auto
Concrete Stress Block	Rectangular
Concrete Rebar Set	ASTM A615
Include WWR	No
Concrete Code	ACI 318-14
HR Steel Pile Code	AISC 14th (360-10): ASD
Wood Pile Code	AWC NDS-15: ASD

Concrete Properties

	Label	E [ksi]	G [ksi]	Nu	Therm (/1E...	Density[lb/f...	f'c[psi]	Lambda	Flex Steel[...	Shear Stee...
1	Conc3000NW	3156	1372	0.15	0.6	145	3000	1	60000	60000
2	Conc3500NW	3409	1482	0.15	0.6	145	3500	1	60000	60000
3	Conc4000NW	3644	1584	0.15	0.6	145	4000	1	60000	60000
4	Conc3000LW	2085	907	0.15	0.6	109.999	3000	0.75	60000	60000
5	Conc3500LW	2252	979	0.15	0.6	109.999	3500	0.75	60000	60000
6	Conc4000LW	2408	1047	0.15	0.6	109.999	4000	0.75	60000	60000
7	Conc2500NW	3156	1372	0.15	0.6	145	2500	1	60000	60000

General Design Parameters

	Label	Max Bending Chk	Max Shear Chk	Top Cover[in]	Bottom Cover[in]
1	Typical	1	1	3	3

Slab Rebar Parameters

	Label	Top BarBottom ...	Max Top Bar...	Min Top Bar ...	Max Bot Bar ...	Min Bot Bar ...	Spacing I...	Side Cove...	Rebar Options	
1	Typical	#5	#5	7	3	7	3	1	0	Optimize

Soil Definitions

	Label	Subgrade Modulus[lb/ft^3]	Allowable Bearing[psf]	Depth Properties	Default?
1	Default	1e+5	1500	None	Yes

Slabs

	Label	Thickness [in]	Material	Local Axis Angle...	Analysis Offset [in]	Passive Pressur...	Soil Overburden ...	lcr Factor
1	S1	24	Conc2500NW	0	0	0	0	1
2	S2	24	Conc2500NW	0	0	0	0	1
3	S3	24	Conc2500NW	0	0	0	0	1
4	S4	24	Conc2500NW	0	0	0	0	1
5	S5	24	Conc2500NW	0	0	0	0	1
6	S6	24	Conc2500NW	0	0	0	0	1
7	S7	24	Conc2500NW	0	0	0	0	1



Slabs (Continued)

	Label	Thickness [in]	Material	Local Axis Angle...	Analysis Offset [in]	Passive Pressur...	Soil Overburden ...	lcr Factor
8	S8	24	Conc2500NW	0	0	0	0	1
9	S9	24	Conc2500NW	0	0	0	0	1

Load Combinations

Label	So..	Se..	A...	SF	Cat...	Fac...	Cat...	Fac...	Cat...	Fac...	Cat...	Fac...	Cat...	Fac...	Cat...	Fac...	Cat...	Fac...	Cat...	Fac...
1	ASD Loa...																			
2	1.0 D	Yes	Yes		1.5	DL	1													
3	1.0 D + 1...	Yes	Yes		1.5	DL	1	RLL	1											
4	1.0 D + 0...	Yes	Yes		1.5	DL	1	RLL		OL1	0.6	WLZ	0.6							
5	1.0 D + 0...	Yes	Yes		1.5	DL	1	RLL		OL2	0.6	WLZ	0.6							
6	1.0 D + 0...	Yes	Yes		1.5	DL	1	RLL		OL3	0.6	WLZ	-0.6							
7	1.0 D + 0...	Yes	Yes		1.5	DL	1	RLL		OL4	0.6	WLZ	-0.6							
8	1.0 D + 0...	Yes	Yes		1.5	DL	1	RLL	0.75	OL1	0.45	WLZ	0.45							
9	1.0 D + 0...	Yes	Yes		1.5	DL	1	RLL	0.75	OL2	0.45	WLZ	0.45							
10	1.0 D + 0...	Yes	Yes		1.5	DL	1	RLL	0.75	OL3	0.45	WLZ	-0.45							
11	1.0 D + 0...	Yes	Yes		1.5	DL	1	RLL	0.75	OL4	0.45	WLZ	-0.45							
12	0.9 D + 0...	Yes	Yes			DL	0.9	RLL		OL1	0.6	WLZ	0.6							
13	0.9 D + 0...	Yes	Yes			DL	0.9	RLL		OL2	0.6	WLZ	0.6							
14	0.9 D + 0...	Yes	Yes			DL	0.9	RLL		OL3	0.6	WLZ	-0.6							
15	0.9 D + 0...	Yes	Yes			DL	0.9	RLL		OL4	0.6	WLZ	-0.6							
16																				
17	LRFD Lo...																			
18	1.4 D	Yes				DL	1.4	RLL												
19	1.2 D + 1...	Yes				DL	1.2	RLL	1.6	OL1	0.5	WLZ	0.5							
20	1.2 D + 1...	Yes				DL	1.2	RLL	1.6	OL2	0.5	WLZ	0.5							
21	1.2 D + 1...	Yes				DL	1.2	RLL	1.6	OL3	0.5	WLZ	-0.5							
22	1.2 D + 1...	Yes				DL	1.2	RLL	1.6	OL4	0.5	WLZ	-0.5							
23	1.2 D + 1...	Yes				DL	1.2	RLL		OL1	1	WLZ	1							
24	1.2 D + 1...	Yes				DL	1.2	RLL		OL2	1	WLZ	1							
25	1.2 D + 1...	Yes				DL	1.2	RLL		OL3	1	WLZ	-1							
26	1.2 D + 1...	Yes				DL	1.2	RLL		OL4	1	WLZ	-1							
27	0.9 D + 1...	Yes				DL	0.9	RLL		OL1	1	WLZ	1							
28	0.9 D + 1...	Yes				DL	0.9	RLL		OL2	1	WLZ	1							
29	0.9 D + 1...	Yes				DL	0.9	RLL		OL3	1	WLZ	-1							
30	0.9 D + 1...	Yes				DL	0.9	RLL		OL4	1	WLZ	-1							

Design Strips

Label	Rebar Angle from Pl...	No. of Design Cuts	Design Rule
DS1	0	50	Typical
DS2	90	50	Typical

Strip Reinforcing

Label	UC Top	LC	Top Bars	Governin...	UC Bot	LC	Bot Bars/...	Governin...	UC Shear	LC	Governin...
DS1	0.028	21	#5@6in	DS1-X25	0.021	28	#5@6in	DS1-X21	0.042	21	DS1-X13
DS2	0	27	#5@7in	DS2-X25	0.001	21	#5@7in	DS2-X25	0.003	21	DS2-X50

Slab Overturning Safety Factors

LC	Slab	Angle[deg]	Mo-xx[lb-ft]	Ms-xx[lb-ft]	Mo-zz[lb-ft]	Ms-zz[lb-ft]	Ms-xx/Mo-xx	Ms-zz/Mo-zz
1	2	S1	0	43070.596	0	7380.793	9.99+	9.99+
2	2	S2	0	43052.994	0	7377.903	9.99+	9.99+
3	2	S3	0	43058.055	0	7379.253	9.99+	9.99+
4	2	S4	0	43024.336	0	7372.366	9.99+	9.99+
5	2	S5	0	43058.037	0	7379.26	9.99+	9.99+
6	2	S6	0	43052.907	0	7377.855	9.99+	9.99+
7	2	S7	0	43070.872	0	7385.538	9.99+	9.99+



Company : Vector Structural Engineering
 Designer : LKN
 Job Number : U2716.0366.231
 Model Name : Ground Mount

Feb 7, 2023
 11:50 AM
 Checked By: _____

Slab Overturning Safety Factors (Continued)

	LC	Slab	Angle[deg]	Mo-xx[lb-ft]	Ms-xx[lb-ft]	Mo-zz[lb-ft]	Ms-zz[lb-ft]	Ms-xx/Mo-xx	Ms-zz/Mo-zz
8	2	S8	0	0	42852.472	0	7327.032	9.99+	9.99+
9	2	S9	0	0	43441.896	0	7480.473	9.99+	9.99+
10	3	S1	0	0	54213.889	0	9653.704	9.99+	9.99+
11	3	S2	0	0	54104.378	0	9634.007	9.99+	9.99+
12	3	S3	0	0	54142.021	0	9652.15	9.99+	9.99+
13	3	S4	0	0	53926.283	0	9603.005	9.99+	9.99+
14	3	S5	0	0	54141.901	0	9643.089	9.99+	9.99+
15	3	S6	0	0	54103.818	0	9641.927	9.99+	9.99+
16	3	S7	0	0	54215.532	0	9691.447	9.99+	9.99+
17	3	S8	0	0	52878.03	0	9301.624	9.99+	9.99+
18	3	S9	0	0	56407.4	0	10211.836	9.99+	9.99+
19	4	S1	0	16906.709	43193.483	1749.69	7380.793	2.555	4.218
20	4	S2	0	16853.9	43161.131	1736.843	7377.963	2.561	4.248
21	4	S3	0	17018.593	43169.186	1748.687	7379.293	2.537	4.22
22	4	S4	0	16467.792	43136.013	1715.253	7372.407	2.619	4.298
23	4	S5	0	17018.939	43169.268	1739.252	7379.299	2.537	4.243
24	4	S6	0	16852.375	43160.754	1739.672	7377.918	2.561	4.241
25	4	S7	0	16917.467	43195.518	1769.023	7385.538	2.553	4.175
26	4	S8	0	15144.706	42908.927	1535.924	7327.2	2.833	4.771
27	4	S9	0	19937.601	43698.132	2087.919	7480.473	2.192	3.583
28	5	S1	0	18400.002	43193.483	1478.628	7380.793	2.347	4.992
29	5	S2	0	18298.392	43161.131	1459.129	7377.963	2.359	5.056
30	5	S3	0	18514.094	43169.186	1468.959	7379.293	2.332	5.023
31	5	S4	0	17857.684	43136.013	1441.714	7372.407	2.416	5.114
32	5	S5	0	18514.553	43169.268	1462.53	7379.299	2.332	5.046
33	5	S6	0	18296.431	43160.754	1456.969	7377.918	2.359	5.064
34	5	S7	0	18413.029	43195.518	1489.139	7385.538	2.346	4.96
35	5	S8	0	16385.475	42908.927	1275.174	7327.2	2.619	5.746
36	5	S9	0	21708.378	43698.132	1750.097	7480.473	2.013	4.274
37	6	S1	0	697.742	44089.527	0	9422.077	9.99+	9.99+
38	6	S2	0	704.258	43908.367	0.06	9404.22	9.99+	9.99+
39	6	S3	0	715.347	43798.834	0.04	9419.389	9.99+	9.99+
40	6	S4	0	684.176	44046.084	0.041	9373.495	9.99+	9.99+
41	6	S5	0	715.339	43798.781	0.039	9408.388	9.99+	9.99+
42	6	S6	0	704.247	43907.829	0.063	9407.472	9.99+	9.99+
43	6	S7	0	698.094	44088.993	0	9449.374	9.99+	9.99+
44	6	S8	0	655.88	43570.589	0.167	9118.944	9.99+	9.99+
45	6	S9	0	800.204	44458.868	0	9916.355	9.99+	9.99+
46	7	S1	0	697.742	47157.604	0	9110.693	9.99+	9.99+
47	7	S2	0	704.258	47014.981	0.06	9103.805	9.99+	9.99+
48	7	S3	0	715.347	46965.468	0.04	9117.115	9.99+	9.99+
49	7	S4	0	684.176	47014.486	0.041	9075.337	9.99+	9.99+
50	7	S5	0	715.339	46965.343	0.039	9105.544	9.99+	9.99+
51	7	S6	0	704.247	47014.616	0.063	9108.248	9.99+	9.99+
52	7	S7	0	698.094	47156.784	0	9141.045	9.99+	9.99+
53	7	S8	0	655.88	46467.991	0.167	8864.585	9.99+	9.99+
54	7	S9	0	800.204	48027.535	0	9557.335	9.99+	9.99+
55	8	S1	0	12680.032	51509.177	1312.267	9085.476	4.062	6.923
56	8	S2	0	12640.425	51337.154	1302.632	9070.026	4.061	6.963
57	8	S3	0	12763.945	51380.153	1311.515	9083.956	4.025	6.926
58	8	S4	0	12350.844	51208.753	1286.44	9045.376	4.146	7.031
59	8	S5	0	12764.204	51380.51	1304.439	9077.161	4.025	6.959
60	8	S6	0	12639.281	51335.566	1304.754	9075.956	4.062	6.956
61	8	S7	0	12688.1	51518.001	1326.767	9114.969	4.06	6.87
62	8	S8	0	11358.53	49991.425	1151.943	8808.102	4.401	7.646
63	8	S9	0	14953.201	53592.798	1565.939	9528.995	3.584	6.085
64	9	S1	0	13800.002	51509.177	1108.971	9085.476	3.733	8.193



Company : Vector Structural Engineering
 Designer : LKN
 Job Number : U2716.0366.231
 Model Name : Ground Mount

Feb 7, 2023
 11:50 AM
 Checked By: _____

Slab Overturning Safety Factors (Continued)

	LC	Slab	Angle[deg]	Mo-xx[lb-ft]	Ms-xx[lb-ft]	Mo-zz[lb-ft]	Ms-zz[lb-ft]	Ms-xx/Mo-xx	Ms-zz/Mo-zz
122	15	S5	0	715.339	42659.539	0.039	8367.618	9.99+	9.99+
123	15	S6	0	704.247	42709.325	0.063	8370.462	9.99+	9.99+
124	15	S7	0	698.094	42849.697	0	8402.491	9.99+	9.99+
125	15	S8	0	655.88	42182.743	0.167	8131.882	9.99+	9.99+
126	15	S9	0	800.204	43683.346	0	8809.288	9.99+	9.99+

Slab Sliding Safety Factors

	LC	Slab	Angle[deg]	Va-xx[lb]	Vr-xx[lb]	Va-zz[lb]	Vr-zz[lb]	SR-xx	SR-zz
1	2	S1	0	1.126	2186.974	0	2186.974	9.99+	9.99+
2	2	S2	0	0	2185.707	0	2185.707	9.99+	9.99+
3	2	S3	0	0	2186.04	0	2186.04	9.99+	9.99+
4	2	S4	0	0	2184.344	0	2184.344	9.99+	9.99+
5	2	S5	0	0	2186.041	0	2186.041	9.99+	9.99+
6	2	S6	0	0	2185.695	0	2185.695	9.99+	9.99+
7	2	S7	0	1.127	2187.032	0	2187.032	9.99+	9.99+
8	2	S8	0	2.13	2174.23	0	2174.23	9.99+	9.99+
9	2	S9	0	3.621	2209.181	0	2209.181	9.99+	9.99+
10	3	S1	0	9.09	2750.573	1.092	2750.573	9.99+	9.99+
11	3	S2	0	2.049	2742.255	1.161	2742.255	9.99+	9.99+
12	3	S3	0	2.272	2744.595	0	2744.595	9.99+	9.99+
13	3	S4	0	0	2733.612	0	2733.612	9.99+	9.99+
14	3	S5	0	2.276	2744.603	0	2744.603	9.99+	9.99+
15	3	S6	0	2.042	2742.19	1.186	2742.19	9.99+	9.99+
16	3	S7	0	9.126	2750.895	1.145	2750.895	9.99+	9.99+
17	3	S8	0	17.069	2667.806	0	2667.806	9.99+	9.99+
18	3	S9	0	22.699	2872.35	0	2872.35	9.99+	9.99+
19	4	S1	0	3.407	1753.901	903.737	1753.901	9.99+	1.941
20	4	S2	0	0.715	1757.693	910.737	1757.693	9.99+	1.93
21	4	S3	0	2.366	1756.621	919.172	1756.621	9.99+	1.911
22	4	S4	0	0	1761.993	886.488	1761.993	9.99+	1.988
23	4	S5	0	2.368	1756.615	919.184	1756.615	9.99+	1.911
24	4	S6	0	0.795	1757.729	910.775	1757.729	9.99+	1.93
25	4	S7	0	3.506	1753.713	903.891	1753.713	9.99+	1.94
26	4	S8	0	7.546	1791.303	839.814	1791.303	9.99+	2.133
27	4	S9	0	10.295	1701.909	1061.47	1701.909	9.99+	1.603
28	5	S1	0	1.114	1821.776	771.324	1821.776	9.99+	2.362
29	5	S2	0	0.526	1826.688	778.786	1826.688	9.99+	2.346
30	5	S3	0	1.936	1825.289	789.747	1825.289	9.99+	2.311
31	5	S4	0	0	1829.349	752.266	1829.349	9.99+	2.432
32	5	S5	0	1.307	1825.277	789.756	1825.277	9.99+	2.311
33	5	S6	0	0.432	1826.737	778.829	1826.737	9.99+	2.345
34	5	S7	0	1.239	1821.515	771.444	1821.515	9.99+	2.361
35	5	S8	0	3.103	1857.697	720.035	1857.697	9.99+	2.58
36	5	S9	0	2.846	1778.622	906.53	1778.622	9.99+	1.962
37	6	S1	0	6.415	2692.22	1040.181	2692.22	9.99+	2.588
38	6	S2	0	0.835	2685.06	1048.284	2685.06	9.99+	2.561
39	6	S3	0	2.76	2687.03	1057.995	2687.03	9.99+	2.54
40	6	S4	0	0	2677.088	1020.259	2677.088	9.99+	2.624
41	6	S5	0	2.763	2687.041	1058.008	2687.041	9.99+	2.54
42	6	S6	0	0.928	2684.992	1048.327	2684.992	9.99+	2.561
43	6	S7	0	6.533	2692.565	1040.356	2692.565	9.99+	2.588
44	6	S8	0	13.418	2620.984	966.377	2620.984	9.99+	2.712
45	6	S9	0	19.856	2800.992	1222.45	2800.992	9.99+	2.291
46	7	S1	0	7.338	2616	899.357	2616	9.99+	2.909
47	7	S2	0	1.155	2611.244	905.1	2611.244	9.99+	2.885
48	7	S3	0	2.897	2612.531	910.486	2612.531	9.99+	2.869



Company : Vector Structural Engineering
 Designer : LKN
 Job Number : U2716.0366.231
 Model Name : Ground Mount

Feb 7, 2023
 11:50 AM
 Checked By: _____

Slab Sliding Safety Factors (Continued)

	LC	Slab	Angle[deg]	Va-xx[lb]	Vr-xx[lb]	Va-zz[lb]	Vr-zz[lb]	SR-xx	SR-zz
49	7	S4	0	0	2603.67	885.71	2603.67	9.99+	2.94
50	7	S5	0	2.897	2612.535	910.498	2612.535	9.99+	2.869
51	7	S6	0	1.153	2611.201	905.129	2611.201	9.99+	2.885
52	7	S7	0	7.404	2616.213	899.522	2616.213	9.99+	2.908
53	7	S8	0	14.052	2558.664	833.32	2558.664	9.99+	3.07
54	7	S9	0	26.16	2709.483	1055.278	2709.483	9.99+	2.568
55	8	S1	0	3.699	2284.868	678.621	2284.868	9.99+	3.367
56	8	S2	0	1	2282.107	682.182	2282.107	9.99+	3.345
57	8	S3	0	0.071	2282.892	689.379	2282.892	9.99+	3.312
58	8	S4	0	0	2279.532	664.866	2279.532	9.99+	3.429
59	8	S5	0	0.069	2282.892	689.388	2282.892	9.99+	3.311
60	8	S6	0	0.935	2282.092	682.192	2282.092	9.99+	3.345
61	8	S7	0	3.651	2284.94	678.777	2284.94	9.99+	3.366
62	8	S8	0	6.077	2257.217	629.861	2257.217	9.99+	3.584
63	8	S9	0	7.493	2326.104	796.103	2326.104	9.99+	2.922
64	9	S1	0	5.419	2335.775	579.312	2335.775	9.99+	4.032
65	9	S2	0	1.931	2333.853	583.219	2333.853	9.99+	4.002
66	9	S3	0	0.252	2334.393	592.31	2334.393	9.99+	3.941
67	9	S4	0	0	2330.049	564.2	2330.049	9.99+	4.13
68	9	S5	0	0.727	2334.389	592.317	2334.389	9.99+	3.941
69	9	S6	0	1.856	2333.848	583.232	2333.848	9.99+	4.002
70	9	S7	0	5.351	2335.792	579.442	2335.792	9.99+	4.031
71	9	S8	0	9.409	2307.013	540.026	2307.013	9.99+	4.272
72	9	S9	0	17.348	2383.639	679.898	2383.639	9.99+	3.506
73	10	S1	0	11.066	2988.608	779.317	2988.608	9.99+	3.835
74	10	S2	0	2.163	2977.632	787.084	2977.632	9.99+	3.783
75	10	S3	0	3.774	2980.698	793.497	2980.698	9.99+	3.756
76	10	S4	0	0	2965.853	765.195	2965.853	9.99+	3.876
77	10	S5	0	3.779	2980.712	793.506	2980.712	9.99+	3.756
78	10	S6	0	2.227	2977.539	787.135	2977.539	9.99+	3.783
79	10	S7	0	11.18	2989.079	779.408	2989.079	9.99+	3.835
80	10	S8	0	21.8	2879.478	724.783	2879.478	9.99+	3.973
81	10	S9	0	30.106	3150.417	916.837	3150.417	9.99+	3.436
82	11	S1	0	11.758	2931.443	673.699	2931.443	9.99+	4.351
83	11	S2	0	2.403	2922.271	679.696	2922.271	9.99+	4.299
84	11	S3	0	3.876	2924.824	682.865	2924.824	9.99+	4.283
85	11	S4	0	0	2910.789	664.282	2910.789	9.99+	4.382
86	11	S5	0	3.88	2924.833	682.874	2924.833	9.99+	4.283
87	11	S6	0	2.396	2922.195	679.736	2922.195	9.99+	4.299
88	11	S7	0	11.834	2931.816	673.783	2931.816	9.99+	4.351
89	11	S8	0	22.276	2832.738	624.99	2832.738	9.99+	4.532
90	11	S9	0	34.834	3081.785	791.458	3081.785	9.99+	3.894
91	12	S1	0	3.52	1535.203	903.737	1535.203	9.99+	1.699
92	12	S2	0	0.715	1539.122	910.737	1539.122	9.99+	1.69
93	12	S3	0	2.366	1538.017	919.172	1538.017	9.99+	1.673
94	12	S4	0	0	1543.559	886.488	1543.559	9.99+	1.741
95	12	S5	0	2.368	1538.01	919.184	1538.01	9.99+	1.673
96	12	S6	0	0.795	1539.159	910.775	1539.159	9.99+	1.69
97	12	S7	0	3.619	1535.01	903.891	1535.01	9.99+	1.698
98	12	S8	0	7.759	1573.88	839.814	1573.88	9.99+	1.874
99	12	S9	0	10.657	1480.991	1061.47	1480.991	9.99+	1.395
100	13	S1	0	1.227	1603.078	771.324	1603.078	9.99+	2.078
101	13	S2	0	0.526	1608.117	778.786	1608.117	9.99+	2.065
102	13	S3	0	1.936	1606.685	789.747	1606.685	9.99+	2.034
103	13	S4	0	0	1610.915	752.266	1610.915	9.99+	2.141
104	13	S5	0	1.307	1606.673	789.756	1606.673	9.99+	2.034
105	13	S6	0	0.432	1608.167	778.829	1608.167	9.99+	2.065



Company : Vector Structural Engineering
 Designer : LKN
 Job Number : U2716.0366.231
 Model Name : Ground Mount

Feb 7, 2023
 11:50 AM
 Checked By: _____

Slab Sliding Safety Factors (Continued)

	LC	Slab	Angle[deg]	Va-xx[lb]	Vr-xx[lb]	Va-zz[lb]	Vr-zz[lb]	SR-xx	SR-zz
106	13	S7	0	1.352	1602.812	771.444	1602.812	9.99+	2.078
107	13	S8	0	3.316	1640.274	720.035	1640.274	9.99+	2.278
108	13	S9	0	2.484	1557.704	906.53	1557.704	9.99+	1.718
109	14	S1	0	6.302	2473.522	1040.181	2473.522	9.99+	2.378
110	14	S2	0	0.835	2466.489	1048.284	2466.489	9.99+	2.353
111	14	S3	0	2.76	2468.426	1057.995	2468.426	9.99+	2.333
112	14	S4	0	0	2458.653	1020.259	2458.653	9.99+	2.41
113	14	S5	0	2.763	2468.437	1058.008	2468.437	9.99+	2.333
114	14	S6	0	0.928	2466.422	1048.327	2466.422	9.99+	2.353
115	14	S7	0	6.42	2473.862	1040.356	2473.862	9.99+	2.378
116	14	S8	0	13.205	2403.561	966.377	2403.561	9.99+	2.487
117	14	S9	0	19.494	2580.074	1222.45	2580.074	9.99+	2.111
118	15	S1	0	7.225	2397.302	899.357	2397.302	9.99+	2.666
119	15	S2	0	1.155	2392.673	905.1	2392.673	9.99+	2.644
120	15	S3	0	2.897	2393.927	910.486	2393.927	9.99+	2.629
121	15	S4	0	0	2385.235	885.71	2385.235	9.99+	2.693
122	15	S5	0	2.897	2393.931	910.498	2393.931	9.99+	2.629
123	15	S6	0	1.153	2392.631	905.129	2392.631	9.99+	2.643
124	15	S7	0	7.291	2397.51	899.522	2397.51	9.99+	2.665
125	15	S8	0	13.839	2341.241	833.32	2341.241	9.99+	2.81
126	15	S9	0	25.798	2488.565	1055.278	2488.565	9.99+	2.358

Envelope Slab Soil Pressures

	Label	Max UC	Max LC	Soil Pressure[psf]	Allowable Bearing[psf]	Point
1	S1	0.402	10	602.362	1500	N1
2	S2	0.4	10	599.723	1500	N36
3	S3	0.402	10	602.733	1500	N40
4	S4	0.396	10	593.327	1500	N44
5	S5	0.402	10	602.744	1500	N48
6	S6	0.4	10	599.679	1500	N52
7	S7	0.402	10	602.643	1500	N56
8	S8	0.375	10	563.118	1500	N60
9	S9	0.442	10	662.274	1500	N64



Company:		Date:	2/2/2023
Engineer:		Page:	1/6
Project:			
Address:			
Phone:			
E-mail:			

1. Project information

Customer company:
Customer contact name:
Customer e-mail:
Comment:

Project description:
Location:
Fastening description:

2. Input Data & Anchor Parameters

General

Design method: ACI 318-14
Units: Imperial units

Anchor Information:

Anchor type: Bonded anchor
Material: F1554 Grade 36
Diameter (inch): 0.375
Effective Embedment depth, h_{ef} (inch): 2.375
Code report: ICC-ES ESR-4057
Anchor category: -
Anchor ductility: Yes
 h_{min} (inch): 3.63
 c_{ac} (inch): 3.81
 C_{min} (inch): 1.75
 S_{min} (inch): 1.00

Base Material

Concrete: Normal-weight
Concrete thickness, h (inch): 24.00
State: Cracked
Compressive strength, f'_c (psi): 2500
 $\Psi_{c,v}$: 1.0
Reinforcement condition: B tension, B shear
Supplemental reinforcement: Not applicable
Reinforcement provided at corners: No
Ignore concrete breakout in tension: No
Ignore concrete breakout in shear: No
Hole condition: Dry concrete
Inspection: Periodic
Temperature range, Short/Long: 150/110°F
Ignore 6do requirement: Not applicable
Build-up grout pad: No

Base Plate

Length x Width x Thickness (inch): 4.75 x 4.75 x 0.25

Recommended Anchor

Anchor Name: SET-3G - SET-3G w/ 3/8"Ø F1554 Gr. 36
Code Report: ICC-ES ESR-4057





Company:		Date:	2/2/2023
Engineer:		Page:	2/6
Project:			
Address:			
Phone:			
E-mail:			

Load and Geometry

Load factor source: ACI 318 Section 5.3

Load combination: not set

Seismic design: No

Anchors subjected to sustained tension: No

Apply entire shear load at front row: No

Anchors only resisting wind and/or seismic loads: No

Strength level loads:

N_{ua} [lb]: 3028

V_{uax} [lb]: 2035

V_{uay} [lb]: 73

M_{ux} [ft-lb]: 0

M_{uy} [ft-lb]: 0

M_{uz} [ft-lb]: 0

<Figure 1>

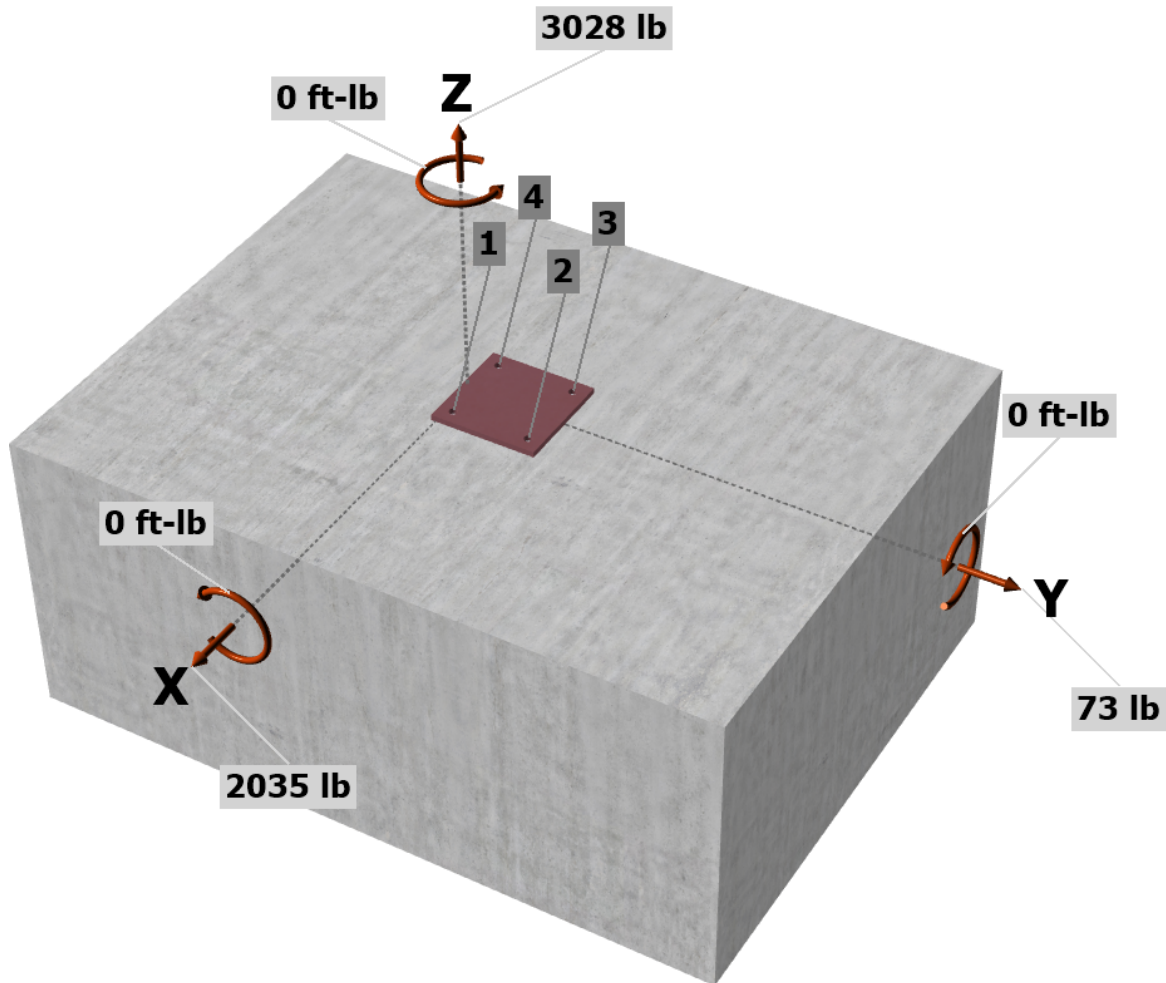

Input data and results must be checked for agreement with the existing circumstances, the standards and guidelines must be checked for plausibility.



Company:		Date:	2/2/2023
Engineer:		Page:	3/6
Project:			
Address:			
Phone:			
E-mail:			

<Figure 2>

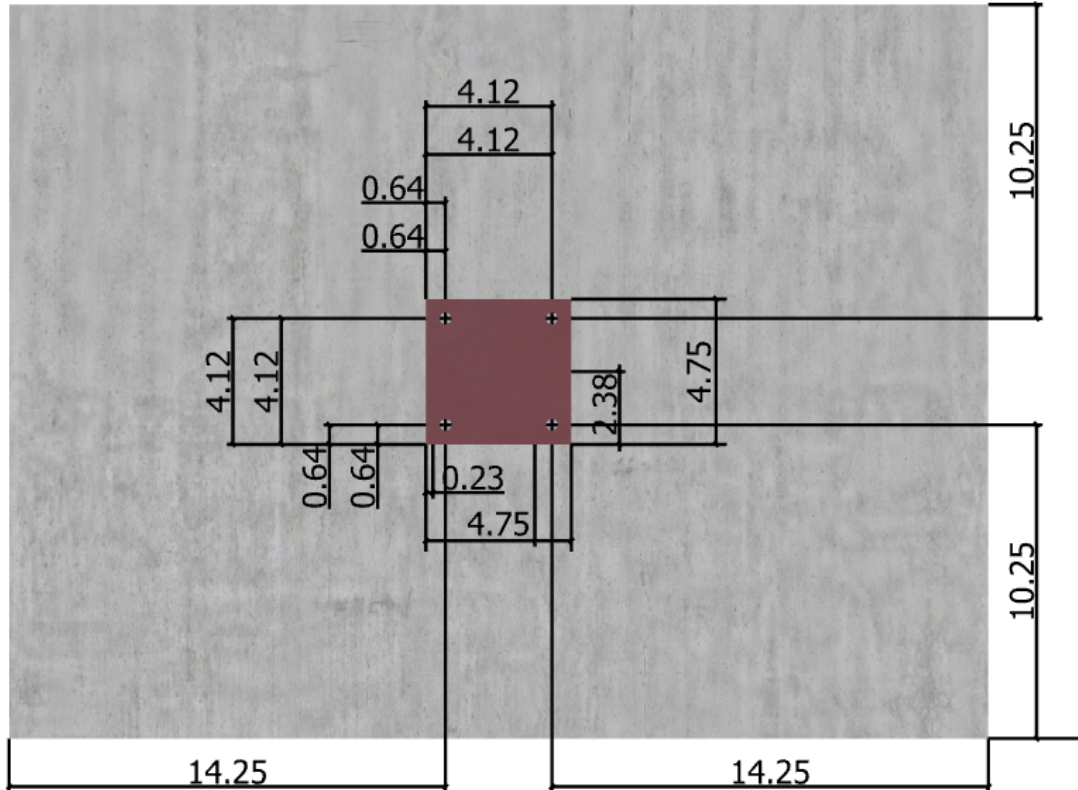



Company:		Date:	2/2/2023
Engineer:		Page:	4/6
Project:			
Address:			
Phone:			
E-mail:			

3. Resulting Anchor Forces

Anchor	Tension load, N_{ua} (lb)	Shear load x, V_{uax} (lb)	Shear load y, V_{uay} (lb)	Shear load combined, $\sqrt{(V_{uax})^2 + (V_{uay})^2}$ (lb)
1	1666.6	823.1	332.6	887.7
2	45.3	194.4	332.6	385.2
3	45.3	194.4	-296.1	354.2
4	1666.6	823.1	-296.1	874.7
Sum	3423.8	2035.0	73.0	2501.9

Maximum concrete compression strain (%): 0.07
 Maximum concrete compression stress (psi): 313
 Resultant tension force (lb): 3424
 Resultant compression force (lb): 396
 Eccentricity of resultant tension forces in x-axis, e'_{Nx} (inch): 1.65
 Eccentricity of resultant tension forces in y-axis, e'_{Ny} (inch): 0.00
 Eccentricity of resultant shear forces in x-axis, e'_{Vx} (inch): 0.00
 Eccentricity of resultant shear forces in y-axis, e'_{Vy} (inch): 0.00

<Figure 3>

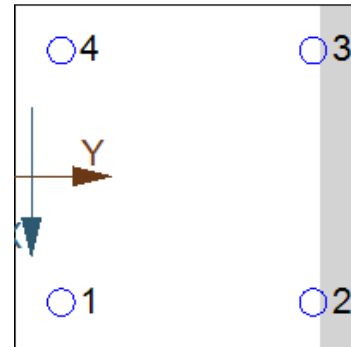

4. Steel Strength of Anchor in Tension (Sec. 17.4.1)

N_{sa} (lb)	ϕ	ϕN_{sa} (lb)
4525	0.75	3394

5. Concrete Breakout Strength of Anchor in Tension (Sec. 17.4.2)

$$N_b = K_c \lambda_a \sqrt{f'_c} h_{ef}^{1.5} \text{ (Eq. 17.4.2.2a)}$$

K_c	λ_a	f'_c (psi)	h_{ef} (in)	N_b (lb)
17.0	1.00	2500	2.375	3111

$$\phi N_{cbg} = \phi (A_{Nc} / A_{Nco}) \psi_{ec,N} \psi_{ed,N} \psi_{c,N} \psi_{cp,N} N_b \text{ (Sec. 17.3.1 \& Eq. 17.4.2.1b)}$$

A_{Nc} (in ²)	A_{Nco} (in ²)	$C_{a,min}$ (in)	$\psi_{ec,N}$	$\psi_{ed,N}$	$\psi_{c,N}$	$\psi_{cp,N}$	N_b (lb)	ϕ	ϕN_{cbg} (lb)
112.47	50.77	10.25	0.684	1.000	1.00	1.000	3111	0.65	3063

6. Adhesive Strength of Anchor in Tension (Sec. 17.4.5)

$$\tau_{k,cr} = \tau_{k,cr,short-term} K_{sat} (f'_c / 2,500)^0$$

$\tau_{k,cr}$ (psi)	$f_{short-term}$	K_{sat}	f'_c (psi)	n	$\tau_{k,cr}$ (psi)
1346	1.00	1.00	2500	0.24	1346

$$N_{ba} = \lambda_a \tau_{cr} \pi d_a h_{ef} \text{ (Eq. 17.4.5.2)}$$

λ_a	τ_{cr} (psi)	d_a (in)	h_{ef} (in)	N_{ba} (lb)
1.00	1346	0.38	2.375	3766

$$\phi N_{ag} = \phi (A_{Na} / A_{Na0}) \psi_{ec,Na} \psi_{ed,Na} \psi_{cp,Na} N_{ba} \text{ (Sec. 17.3.1 \& Eq. 17.4.5.1b)}$$

A_{Na} (in ²)	A_{Na0} (in ²)	C_{Na} (in)	$C_{a,min}$ (in)	$\psi_{ec,Na}$	$\psi_{ed,Na}$	$\psi_{cp,Na}$	N_{ba} (lb)	ϕ	ϕN_{ag} (lb)
197.89	112.09	5.29	10.25	0.763	1.000	1.000	3766	0.55	2789



Company:		Date:	2/2/2023
Engineer:		Page:	5/6
Project:			
Address:			
Phone:			
E-mail:			

8. Steel Strength of Anchor in Shear (Sec. 17.5.1)

V_{sa} (lb)	ϕ_{grout}	ϕ	$\phi_{grout}\phi V_{sa}$ (lb)
2715	1.0	0.65	1765

9. Concrete Breakout Strength of Anchor in Shear (Sec. 17.5.2)

Shear perpendicular to edge in y-direction:

$V_{by} = \min[7(l_e / d_a)^{0.2} \sqrt{d_a} \lambda_a \sqrt{f_c} c_{a1}^{1.5}; 9 \lambda_a \sqrt{f_c} c_{a1}^{1.5}]$ (Eq. 17.5.2.2a & Eq. 17.5.2.2b)

l_e (in)	d_a (in)	λ_a	f_c (psi)	c_{a1} (in)	V_{by} (lb)
2.38	0.375	1.00	2500	16.00	19842

$\phi V_{cbgy} = \phi (A_{vc} / A_{vco}) \psi_{ec,v} \psi_{ed,v} \psi_{c,v} \psi_{h,v} V_{by}$ (Sec. 17.3.1 & Eq. 17.5.2.1b)

A_{vc} (in ²)	A_{vco} (in ²)	$\psi_{ec,v}$	$\psi_{ed,v}$	$\psi_{c,v}$	$\psi_{h,v}$	V_{by} (lb)	ϕ	ϕV_{cbgy} (lb)
575.52	1152.00	1.000	0.828	1.000	1.000	19842	0.70	5746

Shear perpendicular to edge in x-direction:

$V_{bx} = \min[7(l_e / d_a)^{0.2} \sqrt{d_a} \lambda_a \sqrt{f_c} c_{a1}^{1.5}; 9 \lambda_a \sqrt{f_c} c_{a1}^{1.5}]$ (Eq. 17.5.2.2a & Eq. 17.5.2.2b)

l_e (in)	d_a (in)	λ_a	f_c (psi)	c_{a1} (in)	V_{bx} (lb)
2.38	0.375	1.00	2500	13.73	15773

$\phi V_{cbgx} = \phi (A_{vc} / A_{vco}) \psi_{ec,v} \psi_{ed,v} \psi_{c,v} \psi_{h,v} V_{bx}$ (Sec. 17.3.1 & Eq. 17.5.2.1b)

A_{vc} (in ²)	A_{vco} (in ²)	$\psi_{ec,v}$	$\psi_{ed,v}$	$\psi_{c,v}$	$\psi_{h,v}$	V_{bx} (lb)	ϕ	ϕV_{cbgx} (lb)
658.63	848.31	0.950	0.908	1.000	1.000	15773	0.70	7394

Shear parallel to edge in x-direction:

$V_{by} = \min[7(l_e / d_a)^{0.2} \sqrt{d_a} \lambda_a \sqrt{f_c} c_{a1}^{1.5}; 9 \lambda_a \sqrt{f_c} c_{a1}^{1.5}]$ (Eq. 17.5.2.2a & Eq. 17.5.2.2b)

l_e (in)	d_a (in)	λ_a	f_c (psi)	c_{a1} (in)	V_{by} (lb)
2.38	0.375	1.00	2500	10.25	10174

$\phi V_{cbgx} = \phi (2)(A_{vc} / A_{vco}) \psi_{ec,v} \psi_{ed,v} \psi_{c,v} \psi_{h,v} V_{by}$ (Sec. 17.3.1, 17.5.2.1(c) & Eq. 17.5.2.1b)

A_{vc} (in ²)	A_{vco} (in ²)	$\psi_{ec,v}$	$\psi_{ed,v}$	$\psi_{c,v}$	$\psi_{h,v}$	V_{by} (lb)	ϕ	ϕV_{cbgx} (lb)
491.69	472.78	1.000	1.000	1.000	1.000	10174	0.70	14813

Shear parallel to edge in y-direction:

$V_{bx} = \min[7(l_e / d_a)^{0.2} \sqrt{d_a} \lambda_a \sqrt{f_c} c_{a1}^{1.5}; 9 \lambda_a \sqrt{f_c} c_{a1}^{1.5}]$ (Eq. 17.5.2.2a & Eq. 17.5.2.2b)

l_e (in)	d_a (in)	λ_a	f_c (psi)	c_{a1} (in)	V_{bx} (lb)
2.38	0.375	1.00	2500	14.25	16678

$\phi V_{cbgy} = \phi (2)(A_{vc} / A_{vco}) \psi_{ec,v} \psi_{ed,v} \psi_{c,v} \psi_{h,v} V_{bx}$ (Sec. 17.3.1, 17.5.2.1(c) & Eq. 17.5.2.1b)

A_{vc} (in ²)	A_{vco} (in ²)	$\psi_{ec,v}$	$\psi_{ed,v}$	$\psi_{c,v}$	$\psi_{h,v}$	V_{bx} (lb)	ϕ	ϕV_{cbgy} (lb)
512.57	913.78	1.000	1.000	1.000	1.000	16678	0.70	13097

10. Concrete Pryout Strength of Anchor in Shear (Sec. 17.5.3)

$\phi V_{cp} = \phi \min[k_{cp} N_a; k_{cp} N_{cb}] = \phi \min[k_{cp} (A_{Na} / A_{Na0}) \psi_{ed,Na} \psi_{cp,Na} N_{ba}; k_{cp} (A_{Nc} / A_{Nco}) \psi_{ed,N} \psi_{c,N} \psi_{cp,N} N_b]$ (Sec. 17.3.1 & Eq. 17.5.3.1a)

k_{cp}	A_{Na} (in ²)	A_{Na0} (in ²)	$\psi_{ed,Na}$	$\psi_{cp,Na}$	N_{ba} (lb)	N_a (lb)
1.0	49.47	112.09	1.000	1.000	3766	1662

A_{Nc} (in ²)	A_{Nco} (in ²)	$\psi_{ed,N}$	$\psi_{c,N}$	$\psi_{cp,N}$	N_b (lb)	N_{cb} (lb)	ϕ	ϕV_{cp} (lb)
28.12	50.77	1.000	1.000	1.000	3111	1723	0.70	1164

Input data and results must be checked for agreement with the existing circumstances, the standards and guidelines must be checked for plausibility.



Company:		Date:	2/2/2023
Engineer:		Page:	6/6
Project:			
Address:			
Phone:			
E-mail:			

11. Results

Interaction of Tensile and Shear Forces (Sec. 17.6.)

Tension	Factored Load, N_{ua} (lb)	Design Strength, ϕN_n (lb)	Ratio	Status	
Steel	1667	3394	0.49	Pass	
Concrete breakout	3424	3063	1.12	Fail	
Adhesive	3424	2789	1.23	Fail (Governs)	
Shear	Factored Load, V_{ua} (lb)	Design Strength, ϕV_n (lb)	Ratio	Status	
Steel	888	1765	0.50	Pass	
T Concrete breakout y+	665	5746	0.12	Pass	
T Concrete breakout x+	2035	7394	0.28	Pass	
Concrete breakout x+	665	14813	0.04	Pass	
Concrete breakout y-	1646	13097	0.13	Pass	
Concrete breakout, combined	-	-	0.30	Pass	
Pryout	888	1164	0.76	Pass (Governs)	
Interaction check	$N_{ua}/\phi N_n$	$V_{ua}/\phi V_n$	Combined Ratio	Permissible	Status
Sec. 17.6..3	1.23	0.76	199.1%	1.2	Fail

FAIL! Selected anchor type and embedment do not meet the selected design criteria.

12. Warnings

- Designer must exercise own judgement to determine if this design is suitable.
- Refer to manufacturer's product literature for hole cleaning and installation instructions.