



Project Number: U2716-0366-231

April 24, 2024

Sunmodo
14800 NE 65th Street
Vancouver, WA 98682

**REFERENCE: Sunmodo Sunturf Ground Mount B7 – Large Format Panels
Ground Mount PV Array Installation**

To Whom It May Concern:

Per request of Sunmodo, we have been asked to prepare the structural design of a ground-mounted PV solar array system with several foundation options as shown in the attached calculations. Vector Structural Engineering requires that we review each site-specific install, and we are not liable for installs at site specific locations we have not reviewed. This document does not address site-specific installations. The following design parameters are used in our analysis:

- Code: 2021 Arkansas Fire Prevention Code (2021 IBC)
- Minimum Design Loads for Buildings and Other Structures (ASCE 7-16)
- Design wind speed for risk category I structures: 105 mph
- Wind exposure: C
- Ground snow load: 50 psf
- The ground screws and helical piers must be tested to 1.5 times uplift and 2.0 times lateral reactions found in the table below. A minimum of one ground screw or helical pier must be tested.

Load (ASD)	Value (lbs)	Factor of Safety	Test Value (lbs)
UPLIFT	1801	1.5	2702
LATERAL	1221	2	2442

Foundation concrete shall have a minimum compressive strength of 2500 psi at 28 days. Cement for all concrete shall be Type I or II with a minimum of 6% entrained air with a water/cement ratio of 0.50. Maximum aggregate size shall be 3/4". No special inspection of concrete strength is required.

Footings are designed based on an allowable soil bearing pressure of 1500 psf an allowable skin friction of 250 psf, an allowable lateral bearing pressure of 150 pcf, and a coefficient of friction of 0.3. Vector Structural Engineering strongly recommends independent soils testing be performed by a licensed geotechnical engineer to verify the assumed soil parameters.

All ground mounts are to be installed per manufacturer’s recommendations. The use of solar panel support span tables provided by the manufacturer is allowed only where the site conditions and solar panel configuration match the description of the span tables. Electrical engineering is beyond our scope. All work performed must be in accordance with accepted industry-wide methods and applicable safety standards. Vector Structural Engineering assumes no responsibility for improper installation of the solar panels.

Very truly yours,

VECTOR STRUCTURAL ENGINEERING, LLC

Russell Emery, P.E.
Project Engineer

Enclosures

RNE/mih

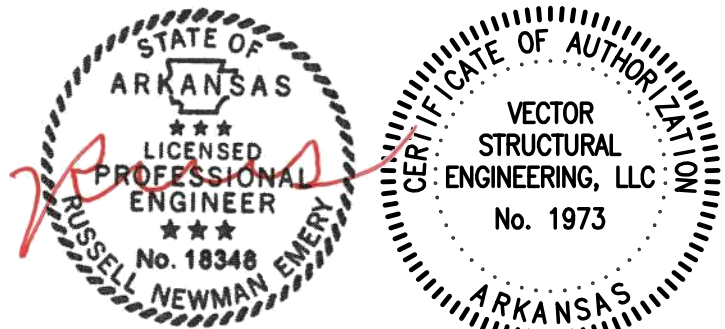

04/24/2024



JOB NO. U2716-0366-231
 PROJECT SUNMODO SUNTURF GROUND MOUNTS B7
 SUBJECT ALL OPTIONS

651 W GALENA PARK BLVD. #101 (801) 990-1775
 DRAPER, UTAH 84020 (801) 990-1776 FAX

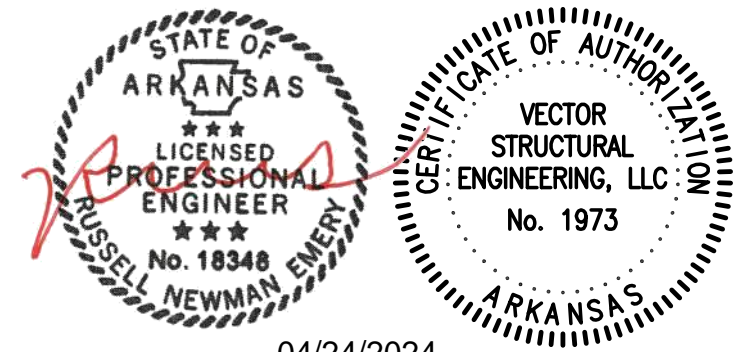

04/24/2024

Vector Structural Engineering requires that we review each site-specific install, and we are not liable for installs at site-specific locations we have not reviewed. This document does not address site-specific installations.

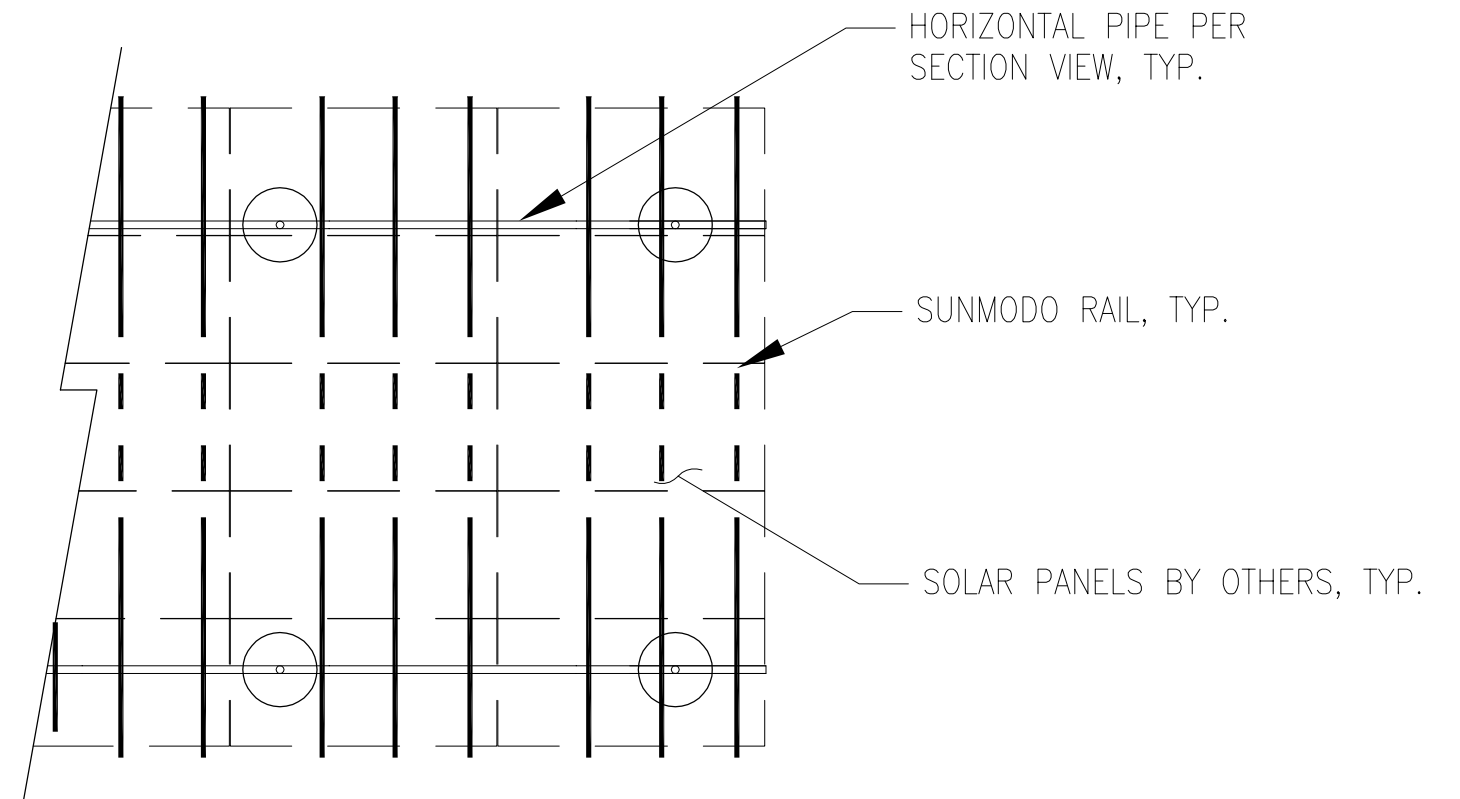
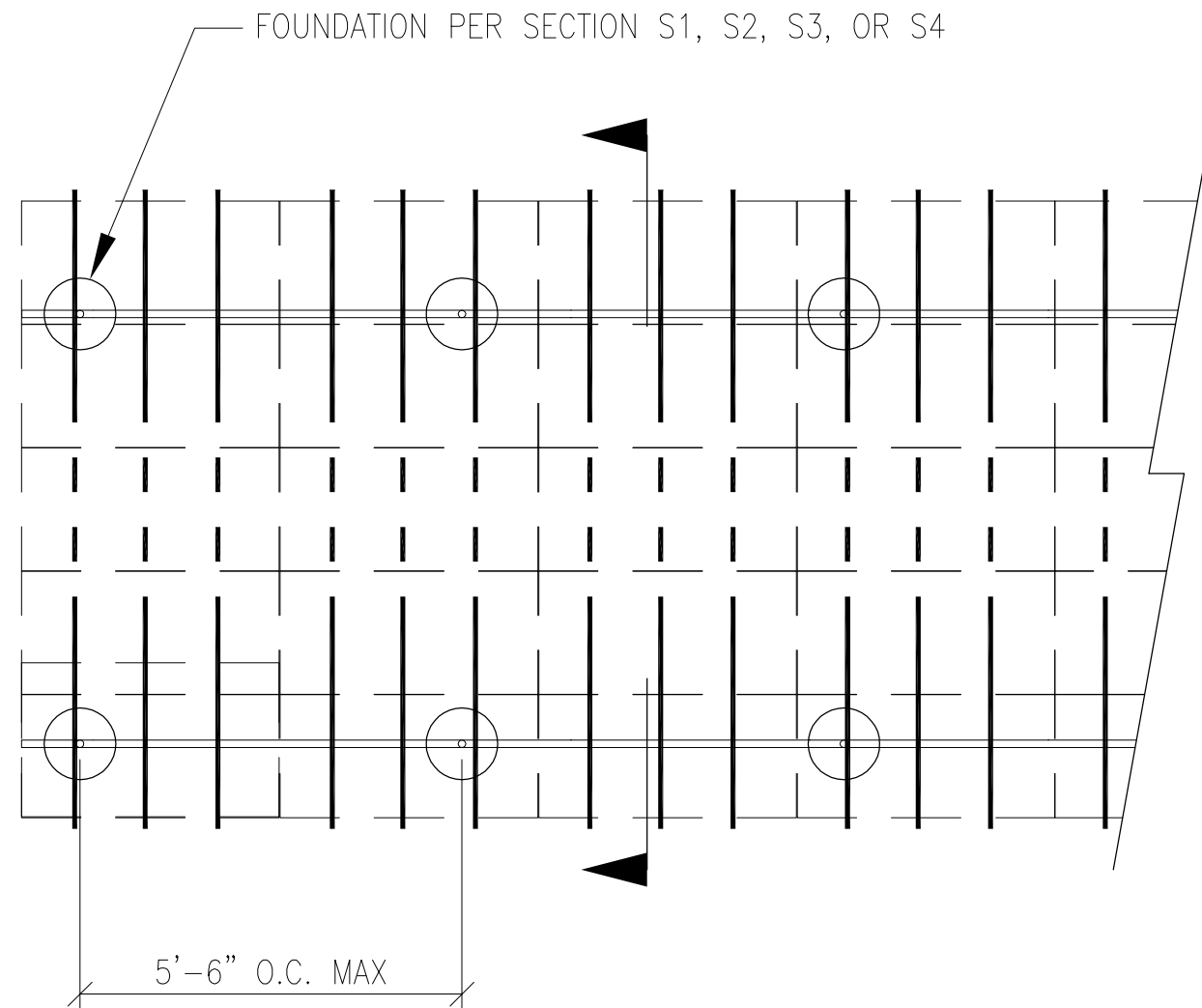

PV ARRAY PLAN

N.T.S.

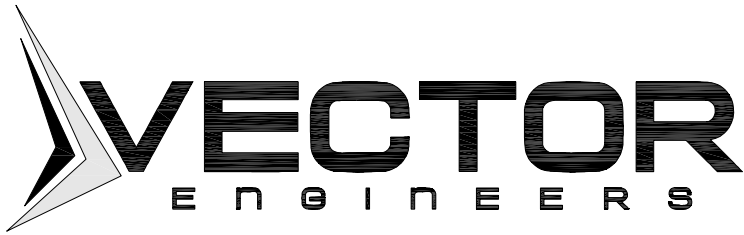

JOB NO. U2716-0366-231

PROJECT SUNMODO SUNTURF GROUND MOUNTS B7

SUBJECT DRILLED PIER OPTION

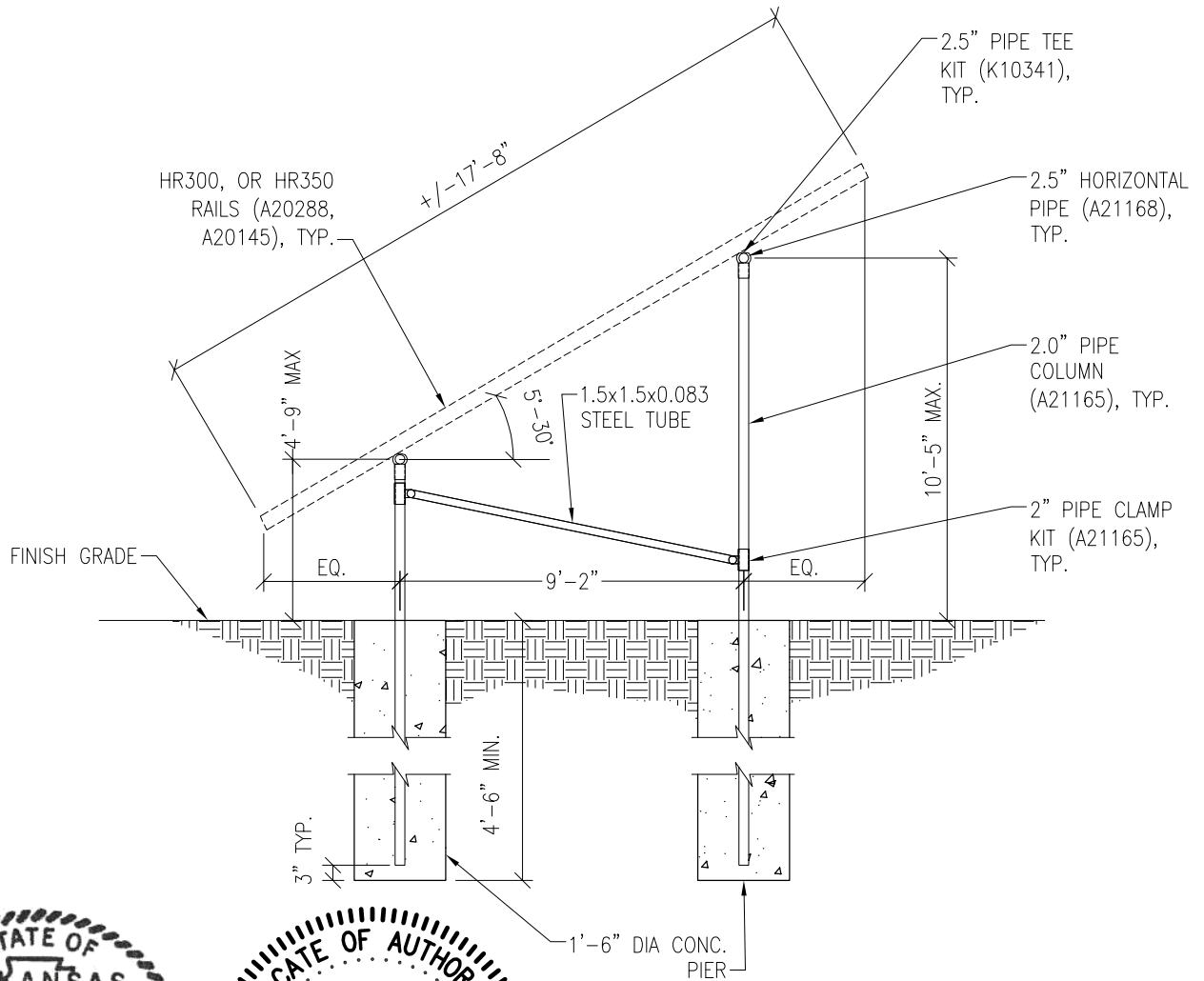

Vector Structural Engineering requires that we review each site-specific install, and we are not liable for installs at site-specific locations we have not reviewed. This document does not address site-specific installations.

PV ARRAY SECTION

N.T.S.

S1

04/24/2024

651 W GALENA PARK BLVD. #101
DRAPER, UTAH 84020

(801) 990-1775

(801) 990-1776 FAX

WWW.VECTORSE.COM

PROJECT SUNMODO SUNTURF GROUND MOUNTS B7

SUBJECT HELICAL PIER OPTION

NOTES:

1. For ground mount components see Section S1.
2. A minimum of (1) installed helical pier must be tested as follows:
 - 2.1. Safety factor for uplift to be 1.5
 - 2.2. S.F. for lateral loads to be 2.0
 - 2.3. Upward deflection limit = 1/2"
 - 2.4. Lateral deflection limit = 1"
 - 2.5. The load tests must be performed by an approved contractor

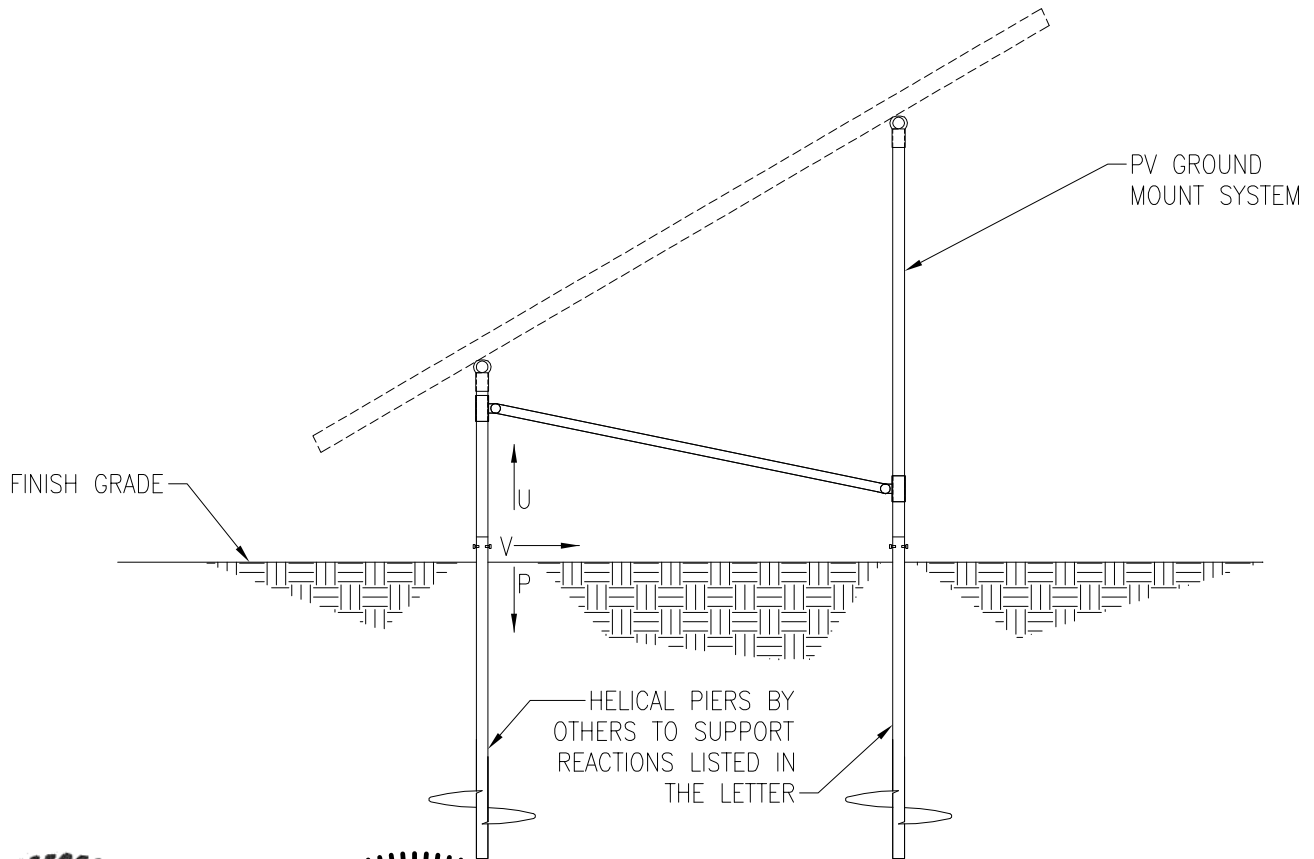

Vector Structural Engineering requires that we review each site-specific install, and we are not liable for installs at site-specific locations we have not reviewed. This document does not address site-specific installations.

PV ARRAY SECTION

N.T.S.

S2

04/24/2024

651 W GALENA PARK BLVD. #101
 DRAPER, UTAH 84020

(801) 990-1775

(801) 990-1776 FAX

WWW.VECTORSE.COM

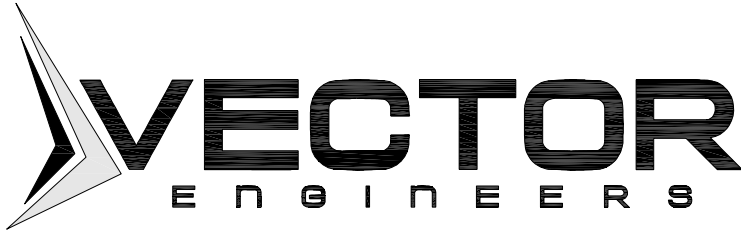

JOB NO. U2716-0366-231

PROJECT SUNMODO SUNTURF GROUND MOUNTS B7

SUBJECT GROUND SCREW OPTION

NOTES:

1. For ground mount components see Section S1.
2. A minimum of (1) installed ground screw must be tested as follows:
 - 2.1. Safety factor for uplift to be 1.5
 - 2.2. S.F. for lateral loads to be 2.0
 - 2.3. Upward deflection limit = 1/2"
 - 2.4. Lateral deflection limit = 1"
 - 2.5. The load tests must be performed by an approved contractor



04/24/2024

Vector Structural Engineering requires that we review each site-specific install, and we are not liable for installs at site-specific locations we have not reviewed. This document does not address site-specific installations.

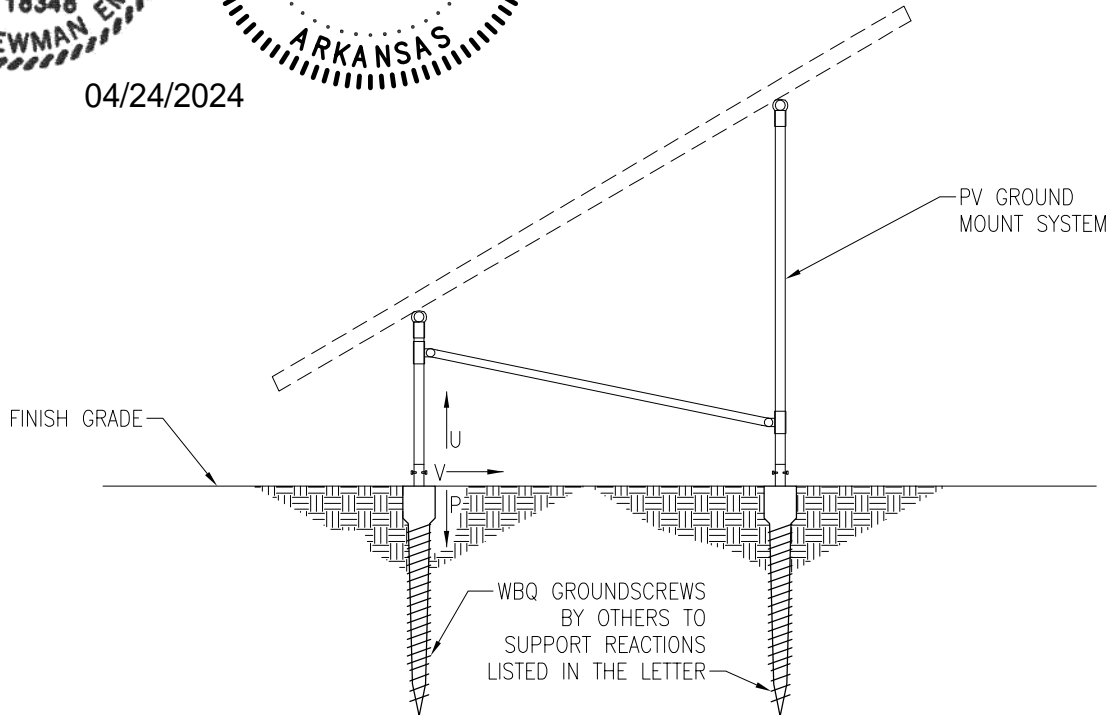

PV ARRAY SECTION

N.T.S.

S3



JOB NO. U2716-0366-231

PROJECT SUNMODO SUNTURF GROUND MOUNTS B6

SUBJECT BALLASTED BLOCK OPTION

NOTES:

1. For ground mount components see Section S1.

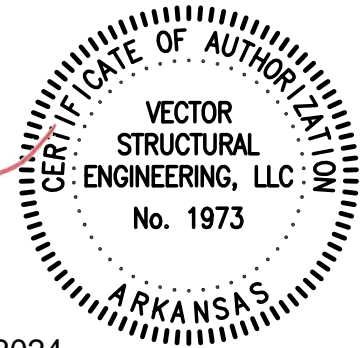

04/24/2024

Vector Structural Engineering requires that we review each site-specific install, and we are not liable for installs at site-specific locations we have not reviewed. This document does not address site-specific installations.

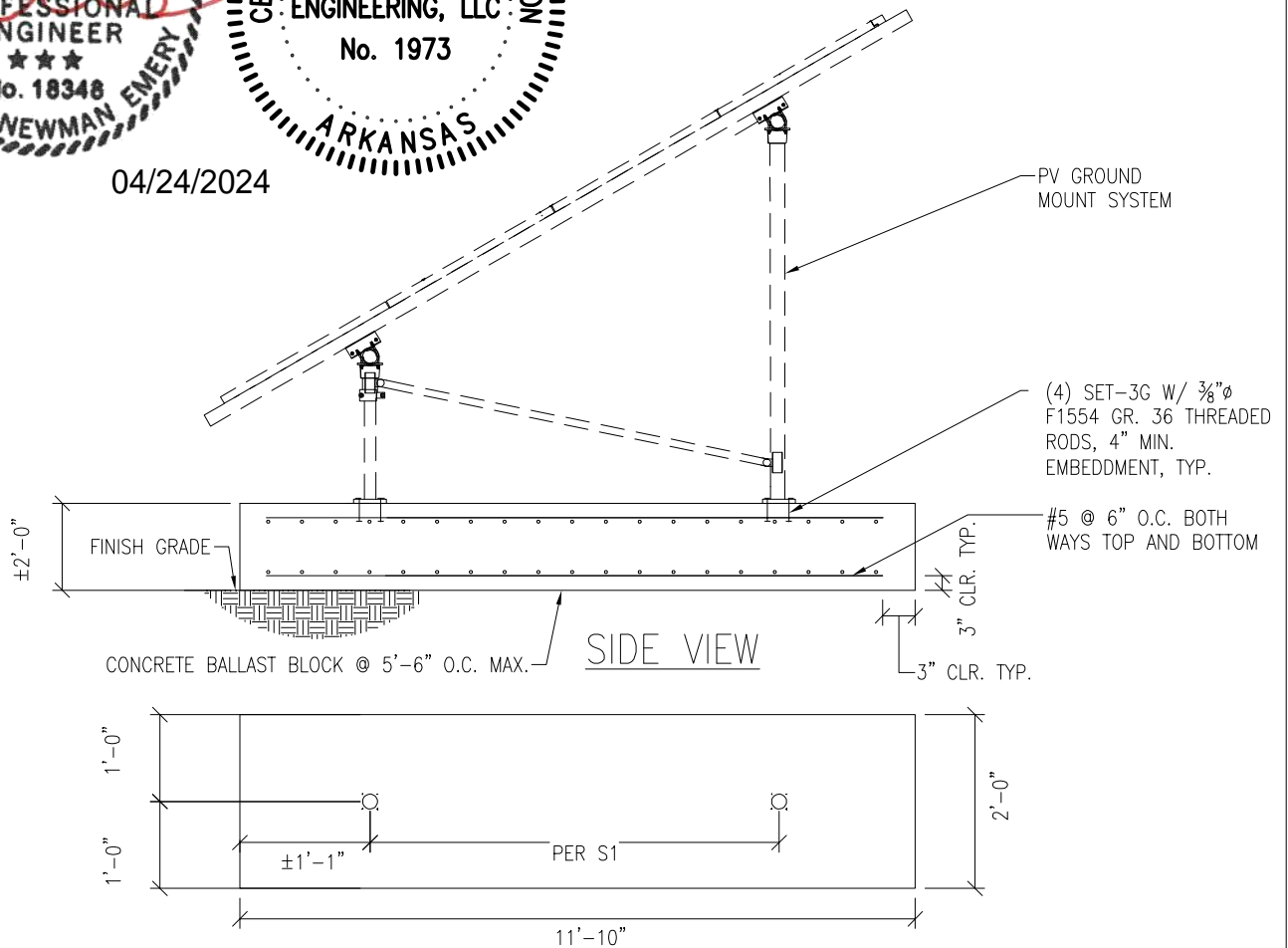

PV ARRAY SECTION

N.T.S.

S4



JOB NO.: U2716.0366.231
SUBJECT: SNOW LOADS

PROJECT: Sunturf Package B7

SNOW LOADS

Calculations Per:	ASCE 7-16	
Snow Ground Load, p_g [psf]:	50.0	(Section 7.2)
Risk Category:	I	(Table 1.5-1)
Importance Factor, I_s :	0.8	(Table 1.5-2)
Terrain Category:	C	(Section 26.7)
Exposure of Roof:	Fully Exposed	(Table 7-3.1)
Exposure Factor, C_e :	0.9	(Table 7-3.1)
Thermal Factor, C_t :	1.2	(Table 7-3.2)
Flat Roof Snow Load, p_f [psf]:	30	(Equation 7.3-1)
Min. Roof Snow Load, p_m [psf]:	0	(Section 7.3.4)
Panel Slope from Horizontal [°]:	30.0	
Unobstructed Slippery Surface?	Yes	(Section 7.4)
Slope Factor Figure:	Figure 7-2c	(of Figure 7.4-1 - See Section 7.4)
Roof Slope Factor, C_s :	0.73	
Sloped Roof Snow Load, p_s [psf]:	22	(Equation 7.4-1)
Design Snow Load, S [psf]:	22	(1.0 Snow)



JOB NO.: U2716.0366.231
SUBJECT: SNOW LOADS

PROJECT: Sunturf Package B7

SNOW LOADS

Calculations Per:	ASCE 7-16	
Snow Ground Load, p_g [psf]:	50.0	(Section 7.2)
Risk Category:	I	(Table 1.5-1)
Importance Factor, I_s :	0.8	(Table 1.5-2)
Terrain Category:	C	(Section 26.7)
Exposure of Roof:	Fully Exposed	(Table 7-3.1)
Exposure Factor, C_e :	0.9	(Table 7-3.1)
Thermal Factor, C_t :	1.2	(Table 7-3.2)
Flat Roof Snow Load, p_f [psf]:	30	(Equation 7.3-1)
Min. Roof Snow Load, p_m [psf]:	0	(Section 7.3.4)
Panel Slope from Horizontal [°]:	15.0	
Unobstructed Slippery Surface?	Yes	(Section 7.4)
Slope Factor Figure:	Figure 7-2c	(of Figure 7.4-1 - See Section 7.4)
Roof Slope Factor, C_s :	1.00	
Sloped Roof Snow Load, p_s [psf]:	30	(Equation 7.4-1)
Design Snow Load, S [psf]:	30	(1.0 Snow)



JOB NO.: U2716.0366.231
SUBJECT: SNOW LOADS

PROJECT: Sunturf Package B7

SNOW LOADS

Calculations Per:	ASCE 7-16	
Snow Ground Load, p_g [psf]:	50.0	(Section 7.2)
Risk Category:	I	(Table 1.5-1)
Importance Factor, I_s :	0.8	(Table 1.5-2)
Terrain Category:	C	(Section 26.7)
Exposure of Roof:	Fully Exposed	(Table 7-3.1)
Exposure Factor, C_e :	0.9	(Table 7-3.1)
Thermal Factor, C_t :	1.2	(Table 7-3.2)
Flat Roof Snow Load, p_f [psf]:	30	(Equation 7.3-1)
Min. Roof Snow Load, p_m [psf]:	16	(Section 7.3.4)
Panel Slope from Horizontal [°]:	5.0	
Unobstructed Slippery Surface?	Yes	(Section 7.4)
Slope Factor Figure:	Figure 7-2c	(of Figure 7.4-1 - See Section 7.4)
Roof Slope Factor, C_s :	1.00	
Sloped Roof Snow Load, p_s [psf]:	30	(Equation 7.4-1)
Design Snow Load, S [psf]:	30	(1.0 Snow)



PROJECT: Sunturf Package B7 Ground Mount

WIND PRESSURES

Calculations per:	ASCE 7-16	
Design Wind Speed, V [mph]:	105	
Risk Category:	I	(Table 1.5-1)
Exposure Category:	C	(Section 26.7)
Elevation [ft]:	2769.9	
Ground Elevation Factor, K_e :	0.90	(Table 26.9-1)
α :	9.5	(Table 26.11-1)
z_g [ft]:	900	(Table 26.11-1)
Velocity Pressure Exposure Coefficient, K_h :	0.85	(Table 26.10-1)
Topographic Factor, K_{ht} :	1.0	(Section 26.8)
Wind Directionality Factor, K_d :	0.85	(Table 26.6-1)
Internal Pressure Coefficient, GC_{pi} :	0.00	(Figure 26.13-1)
Velocity Pressure, q_h [psf]:	18.42	(Equation 26.10-1)
Gust Effect Factor, G:	0.85	(Section 26.11.4)
Panel Slope [degrees]:	30.0	
Wind Flow:	Clear	
Roof Configuration:	Monoslope	

Wind Pressures in Transverse (N-S) Direction

Net Pressure Coefficients per Figure 27.3-4

Clear Wind Flow	C_{NW}	C_{NL}
Case 1 ($\gamma = 0^\circ$, Load Case A)	-1.8	-1.8
Case 2 ($\gamma = 0^\circ$, Load Case B)	-2.5	-0.5
Case 3 ($\gamma = 180^\circ$, Load Case A)	2.1	2.1
Case 4 ($\gamma = 180^\circ$, Load Case B)	2.6	1.0

Design Wind Pressures per Equation 27.3-2 [psf]

Clear Wind Flow	$q_h GC_{NW}$	$q_h GC_{NL}$
Case 1 ($\gamma = 0^\circ$, Load Case A)	-28.2	-28.2
Case 2 ($\gamma = 0^\circ$, Load Case B)	-39.1	-7.8
Case 3 ($\gamma = 180^\circ$, Load Case A)	32.9	32.9
Case 4 ($\gamma = 180^\circ$, Load Case B)	40.7	15.7
Case 5 ($\gamma = 0^\circ$, 16 psf Min. Horiz.)	-16.0	-16.0
Case 6 ($\gamma = 180^\circ$, 16 psf Min. Horiz)	16.0	16.0



PROJECT: Sunturf Package B7 Ground Mount

WIND PRESSURES

Calculations per:	ASCE 7-16	
Design Wind Speed, V [mph]:	105	
Risk Category:	I	(Table 1.5-1)
Exposure Category:	C	(Section 26.7)
Elevation [ft]:	2769.9	
Ground Elevation Factor, K_e :	0.90	(Table 26.9-1)
α :	9.5	(Table 26.11-1)
z_g [ft]:	900	(Table 26.11-1)
Velocity Pressure Exposure Coefficient, K_h :	0.85	(Table 26.10-1)
Topographic Factor, K_{ht} :	1.0	(Section 26.8)
Wind Directionality Factor, K_d :	0.85	(Table 26.6-1)
Internal Pressure Coefficient, GC_{pi} :	0.00	(Figure 26.13-1)
Velocity Pressure, q_h [psf]:	18.42	(Equation 26.10-1)
Gust Effect Factor, G:	0.85	(Section 26.11.4)
Panel Slope [degrees]:	15.0	
Wind Flow:	Clear	
Roof Configuration:	Monoslope	

Wind Pressures in Transverse (N-S) Direction

Net Pressure Coefficients per Figure 27.3-4

Clear Wind Flow	C_{NW}	C_{NL}
Case 1 ($\gamma = 0^\circ$, Load Case A)	-0.9	-1.3
Case 2 ($\gamma = 0^\circ$, Load Case B)	-1.9	0.0
Case 3 ($\gamma = 180^\circ$, Load Case A)	1.3	1.6
Case 4 ($\gamma = 180^\circ$, Load Case B)	1.8	0.6

Design Wind Pressures per Equation 27.3-2 [psf]

Clear Wind Flow	$q_h GC_{NW}$	$q_h GC_{NL}$
Case 1 ($\gamma = 0^\circ$, Load Case A)	-14.1	-20.4
Case 2 ($\gamma = 0^\circ$, Load Case B)	-29.8	0.0
Case 3 ($\gamma = 180^\circ$, Load Case A)	20.4	25.1
Case 4 ($\gamma = 180^\circ$, Load Case B)	28.2	9.4
Case 5 ($\gamma = 0^\circ$, 16 psf Min. Horiz.)	-16.0	-16.0
Case 6 ($\gamma = 180^\circ$, 16 psf Min. Horiz)	16.0	16.0



PROJECT: Sunturf Package B7 Ground Mount

WIND PRESSURES

Calculations per:	ASCE 7-16	
Design Wind Speed, V [mph]:	105	
Risk Category:	I	(Table 1.5-1)
Exposure Category:	C	(Section 26.7)
Elevation [ft]:	2769.9	
Ground Elevation Factor, K_e :	0.90	(Table 26.9-1)
α :	9.5	(Table 26.11-1)
z_g [ft]:	900	(Table 26.11-1)
Velocity Pressure Exposure Coefficient, K_h :	0.85	(Table 26.10-1)
Topographic Factor, K_{ht} :	1.0	(Section 26.8)
Wind Directionality Factor, K_d :	0.85	(Table 26.6-1)
Internal Pressure Coefficient, GC_{pi} :	0.00	(Figure 26.13-1)
Velocity Pressure, q_h [psf]:	18.42	(Equation 26.10-1)
Gust Effect Factor, G:	0.85	(Section 26.11.4)
Panel Slope [degrees]:	5.0	
Wind Flow:	Clear	
Roof Configuration:	Monoslope	

Wind Pressures in Transverse (N-S) Direction

Net Pressure Coefficients per Figure 27.3-4

Clear Wind Flow	C_{NW}	C_{NL}
Case 1 ($\gamma = 0^\circ$, Load Case A)	1.2	0.3
Case 2 ($\gamma = 0^\circ$, Load Case B)	-1.1	-0.1
Case 3 ($\gamma = 180^\circ$, Load Case A)	1.2	0.3
Case 4 ($\gamma = 180^\circ$, Load Case B)	-1.1	-0.1

Design Wind Pressures per Equation 27.3-2 [psf]

Clear Wind Flow	$q_h GC_{NW}$	$q_h GC_{NL}$
Case 1 ($\gamma = 0^\circ$, Load Case A)	18.8	4.7
Case 2 ($\gamma = 0^\circ$, Load Case B)	-17.2	-1.6
Case 3 ($\gamma = 180^\circ$, Load Case A)	18.8	4.7
Case 4 ($\gamma = 180^\circ$, Load Case B)	-17.2	-1.6
Case 5 ($\gamma = 0^\circ$, 16 psf Min. Horiz.)	-16.0	-16.0
Case 6 ($\gamma = 180^\circ$, 16 psf Min. Horiz)	16.0	16.0

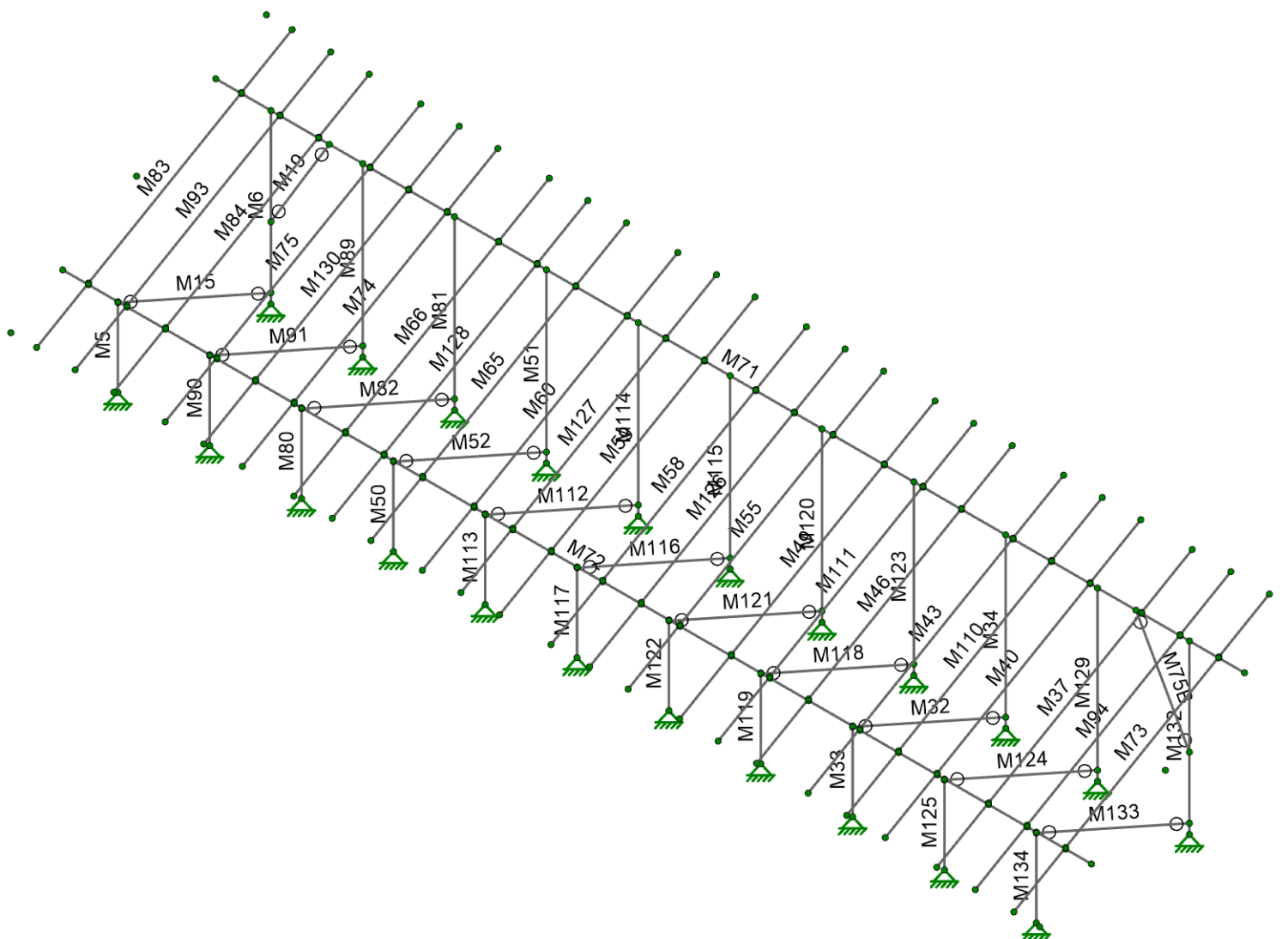
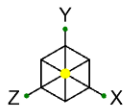

Vector Structural Engineering

LKN

U2716.0366.231

Sunturf Ground Mount B7 LF 30°

SK-1

Feb 02, 2023

Sunturf Ground Mount B7 LF 30deg 3R.r3d

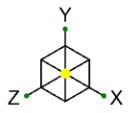

Section Sets	
█	Post
█	Cross Beam
█	Diagonal Brace
█	RIGID
█	AL Rails

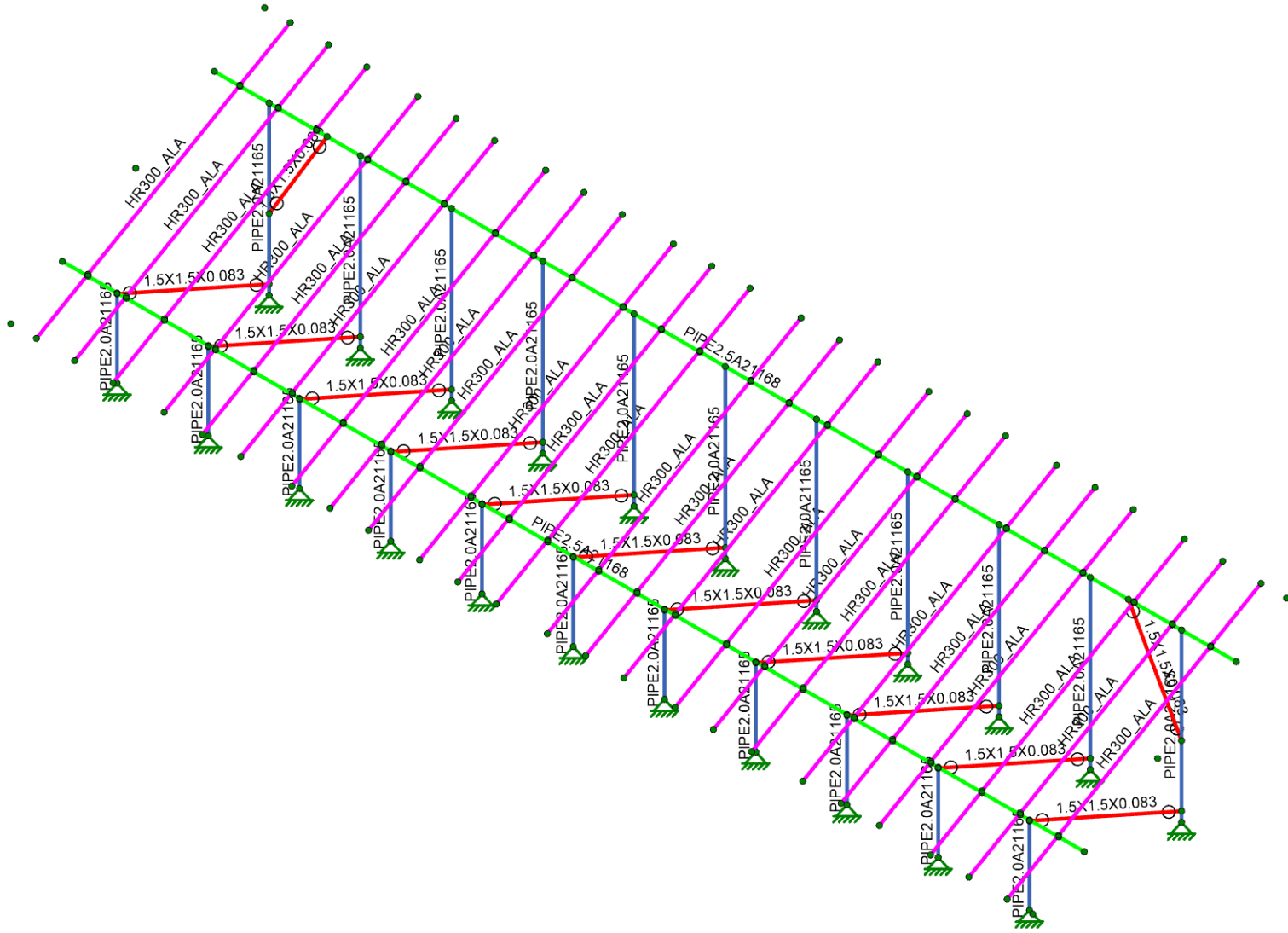

Vector Structural Engineering	Sunturf Ground Mount B7 LF 30°	SK-2
LKN		Feb 02, 2023
U2716.0366.231		Sunturf Ground Mount B7 LF 30deg 3R.r3d

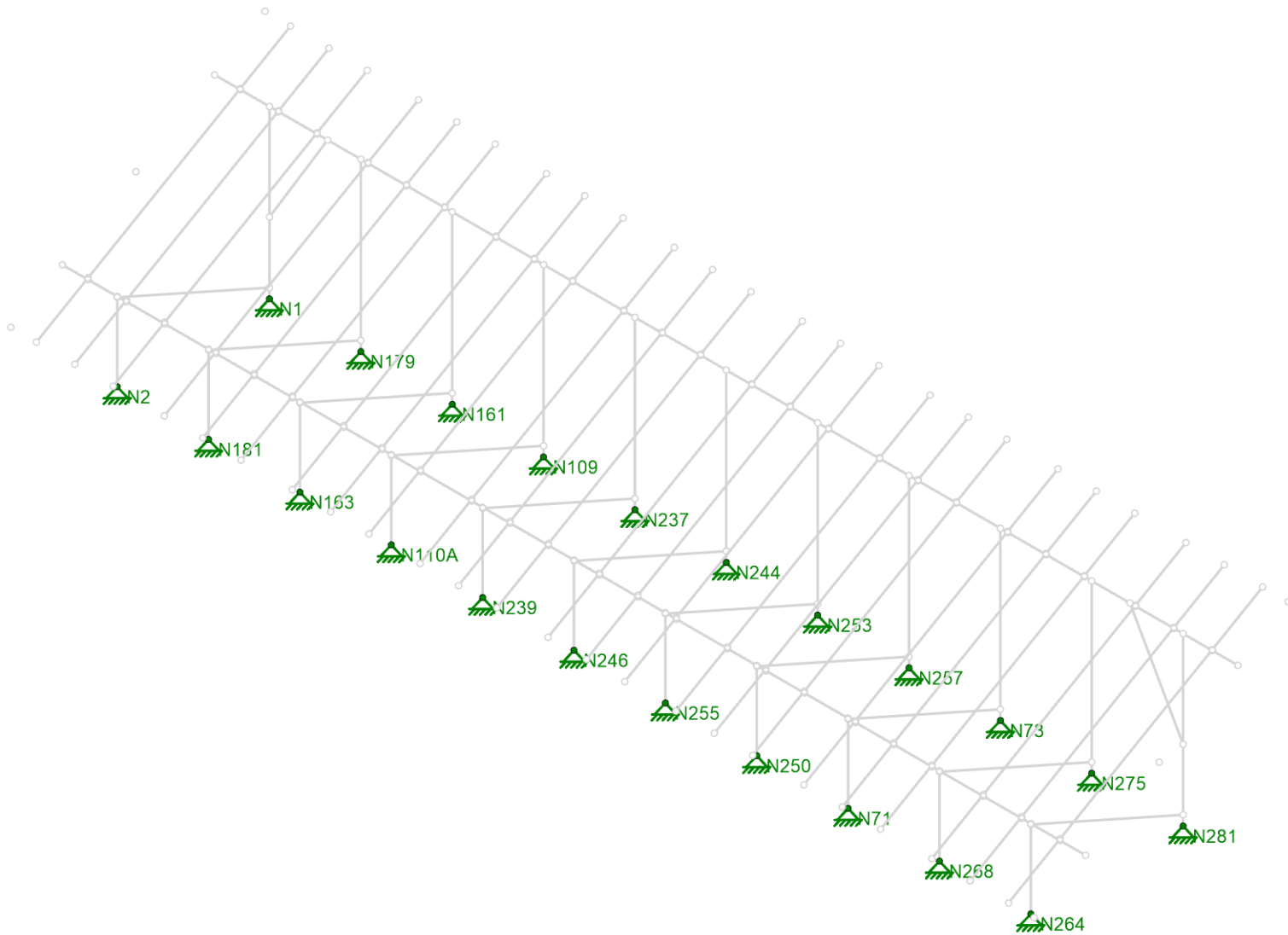
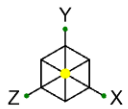

Vector Structural Engineering

LKN

U2716.0366.231

Sunturf Ground Mount B7 LF 30°

SK-3

Feb 02, 2023

Sunturf Ground Mount B7 LF 30deg 3R.r3d

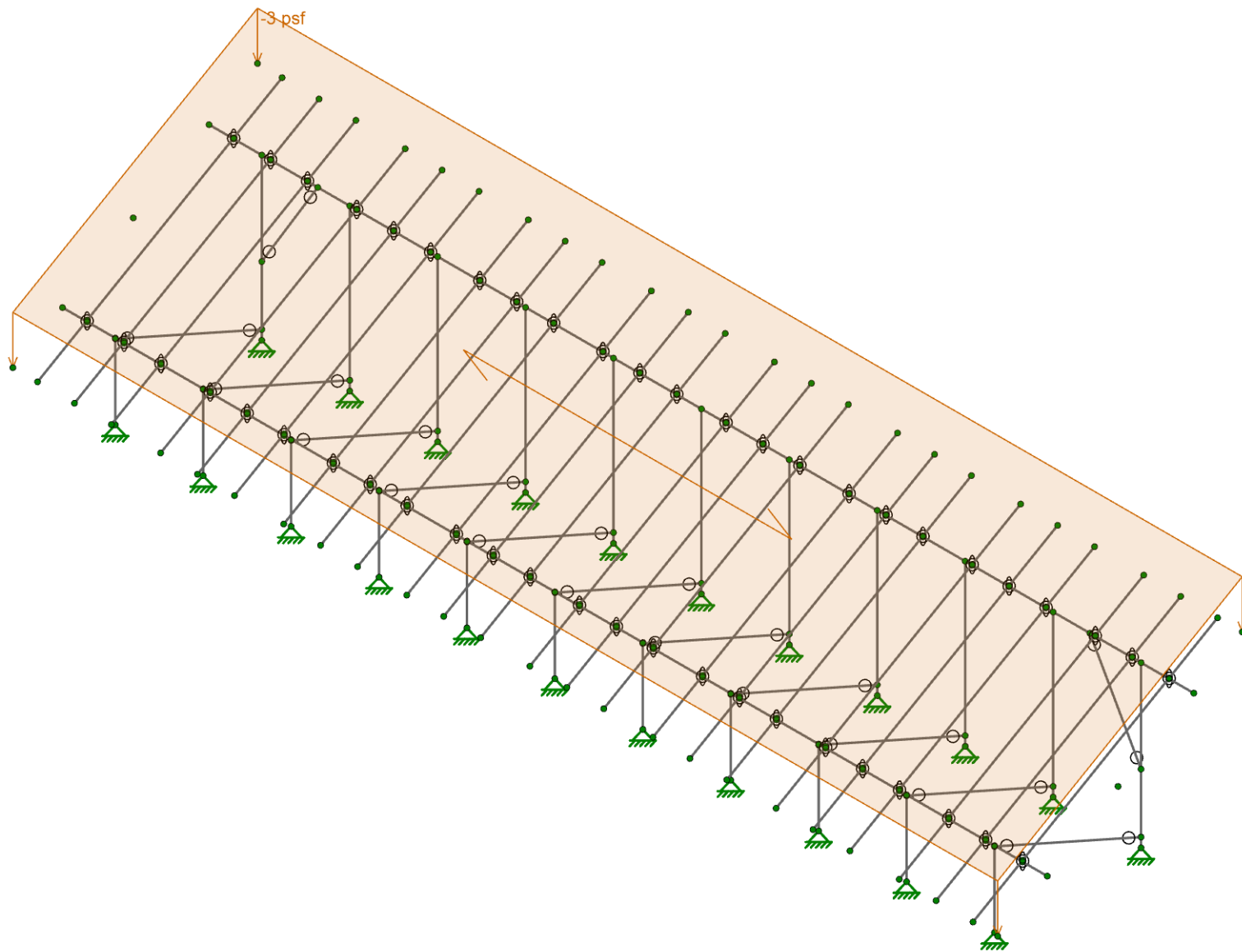
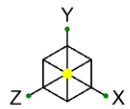

Loads: BLC 2, Solar Panel Weight

Vector Structural Engineering

LKN

U2716.0366.231

Sunturf Ground Mount B7 LF 30°

SK-4

Feb 02, 2023

Sunturf Ground Mount B7 LF 30deg 3R.r3d

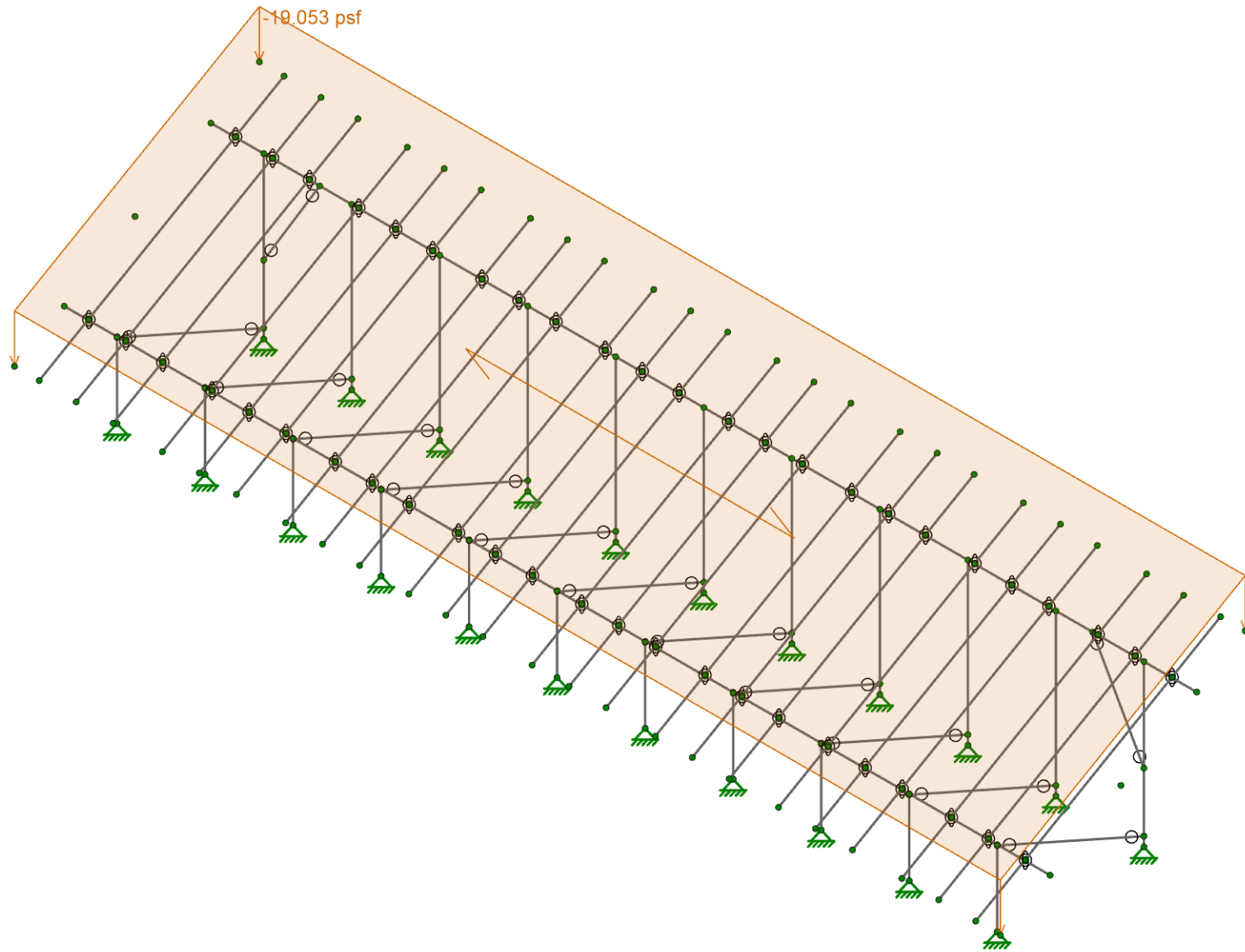
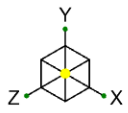

Loads: BLC 3, Roof Live/Snow

Vector Structural Engineering
LKN
U2716.0366.231

Sunturf Ground Mount B7 LF 30°

SK-5
Feb 02, 2023
Sunturf Ground Mount B7 LF 30deg 3R.r3d

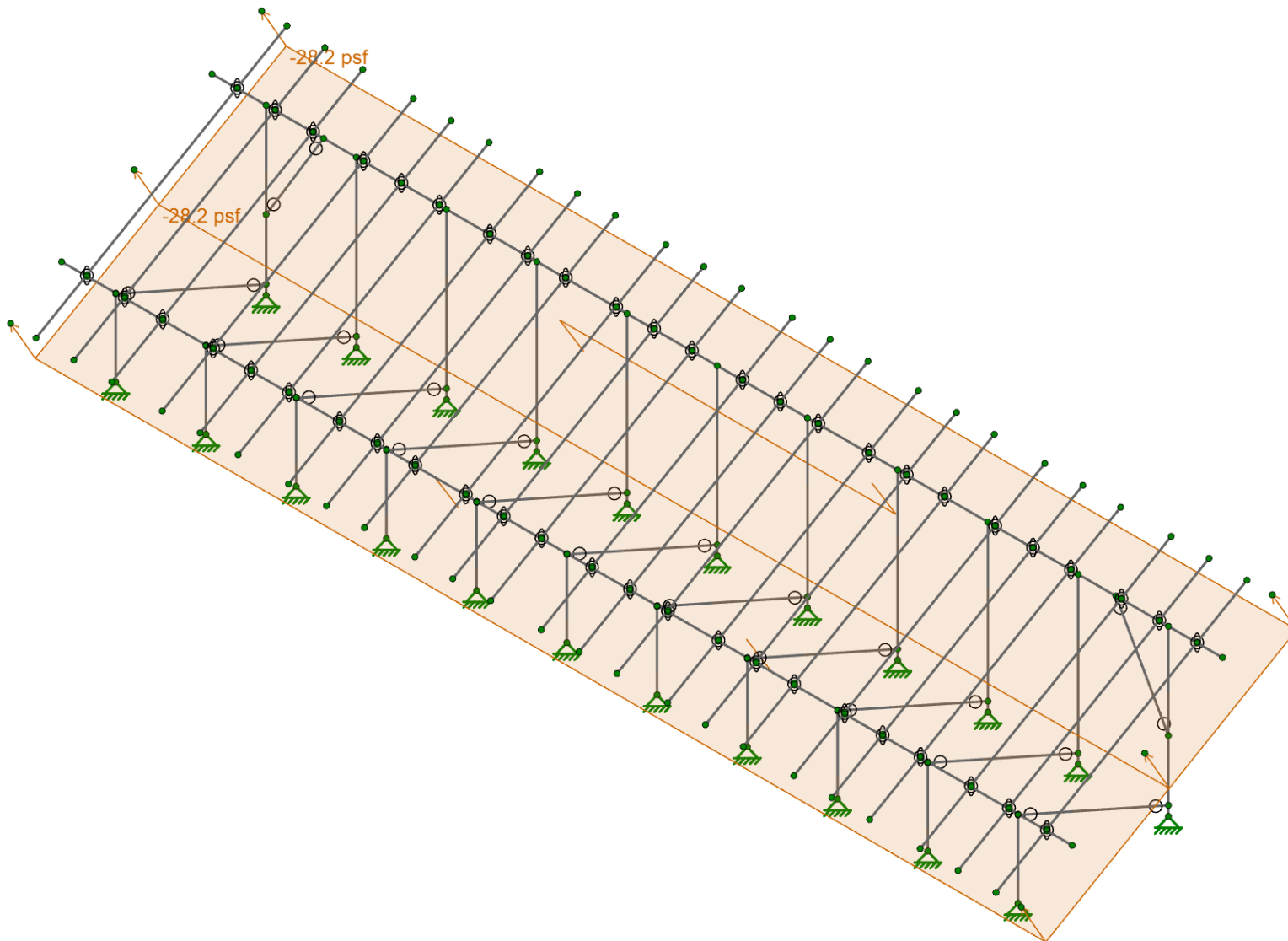
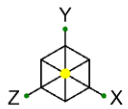

Loads: BLC 4, Wind A 0 deg		Sunturf Ground Mount B7 LF 30°	SK-6
Vector Structural Engineering			Feb 02, 2023
LKN			Sunturf Ground Mount B7 LF 30deg 3R.r3d
U2716.0366.231			

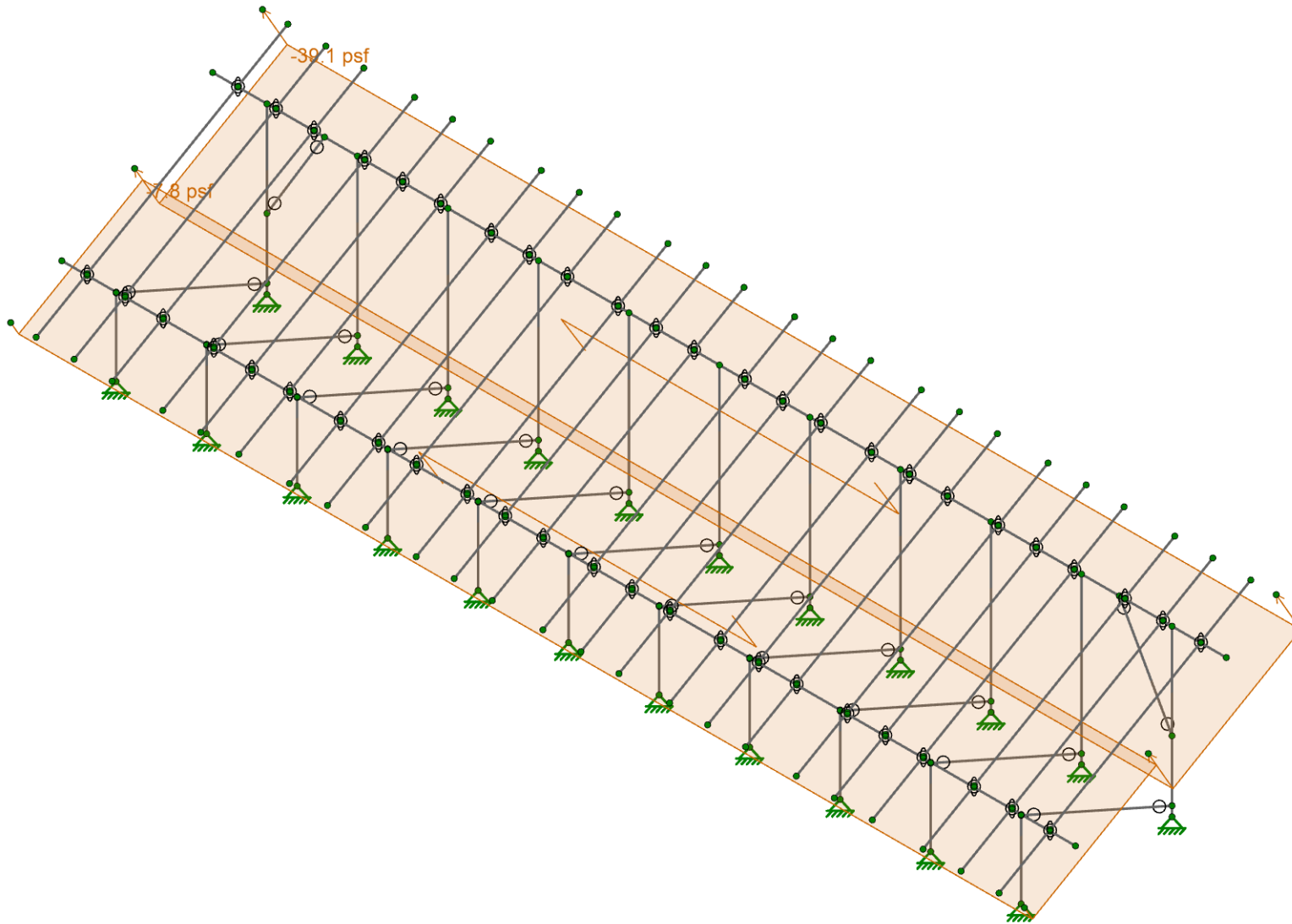
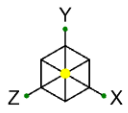

Loads: BLC 5, Wind B 0 deg

Vector Structural Engineering
LKN
U2716.0366.231

Sunturf Ground Mount B7 LF 30°

SK-7
Feb 02, 2023
Sunturf Ground Mount B7 LF 30deg 3R.r3d

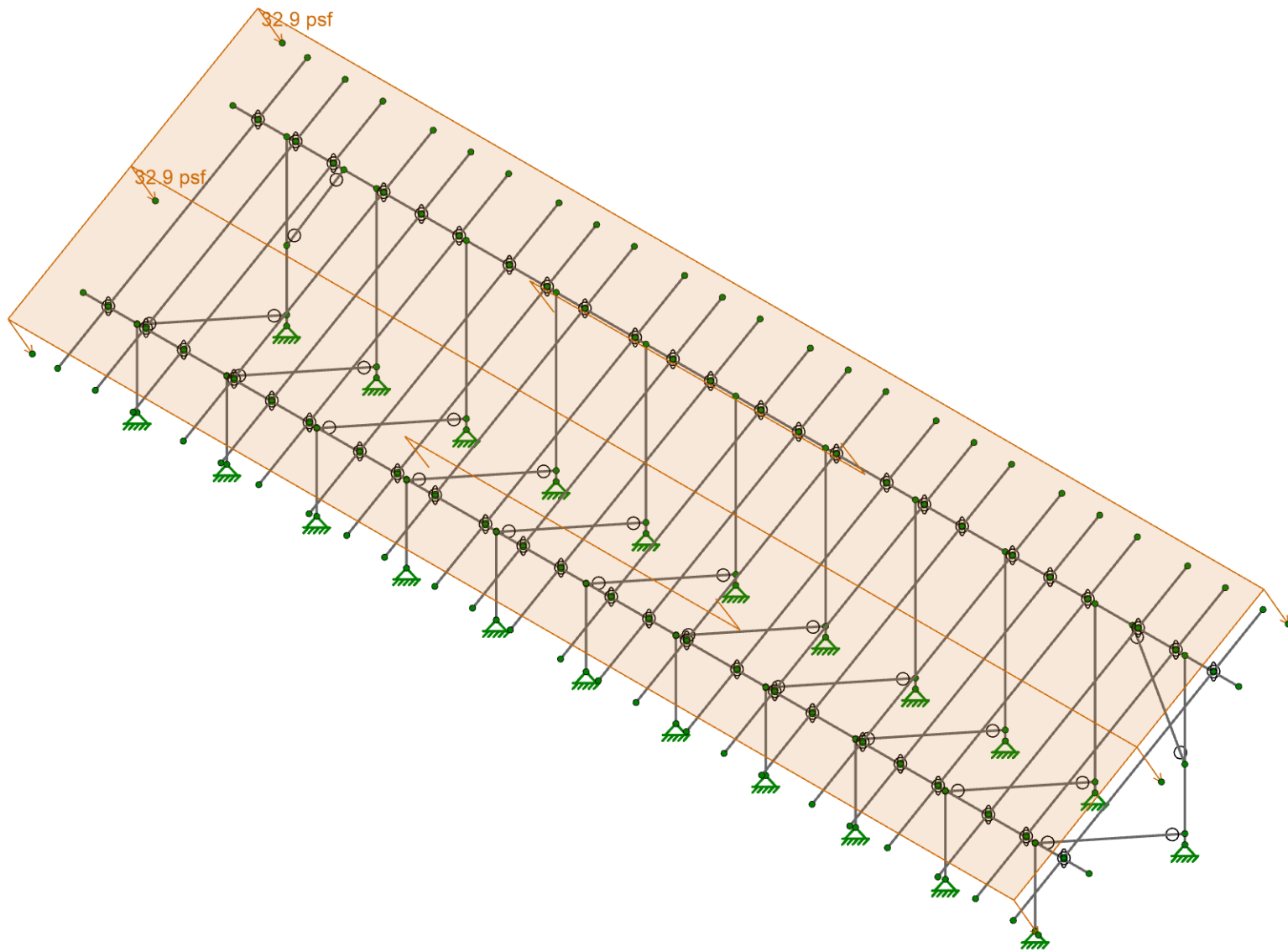
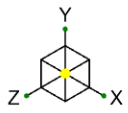

Loads: BLC 6, Wind A 180 deg

Vector Structural Engineering
LKN
U2716.0366.231

Sunturf Ground Mount B7 LF 30°

SK-8
Feb 02, 2023
Sunturf Ground Mount B7 LF 30deg 3R.r3d

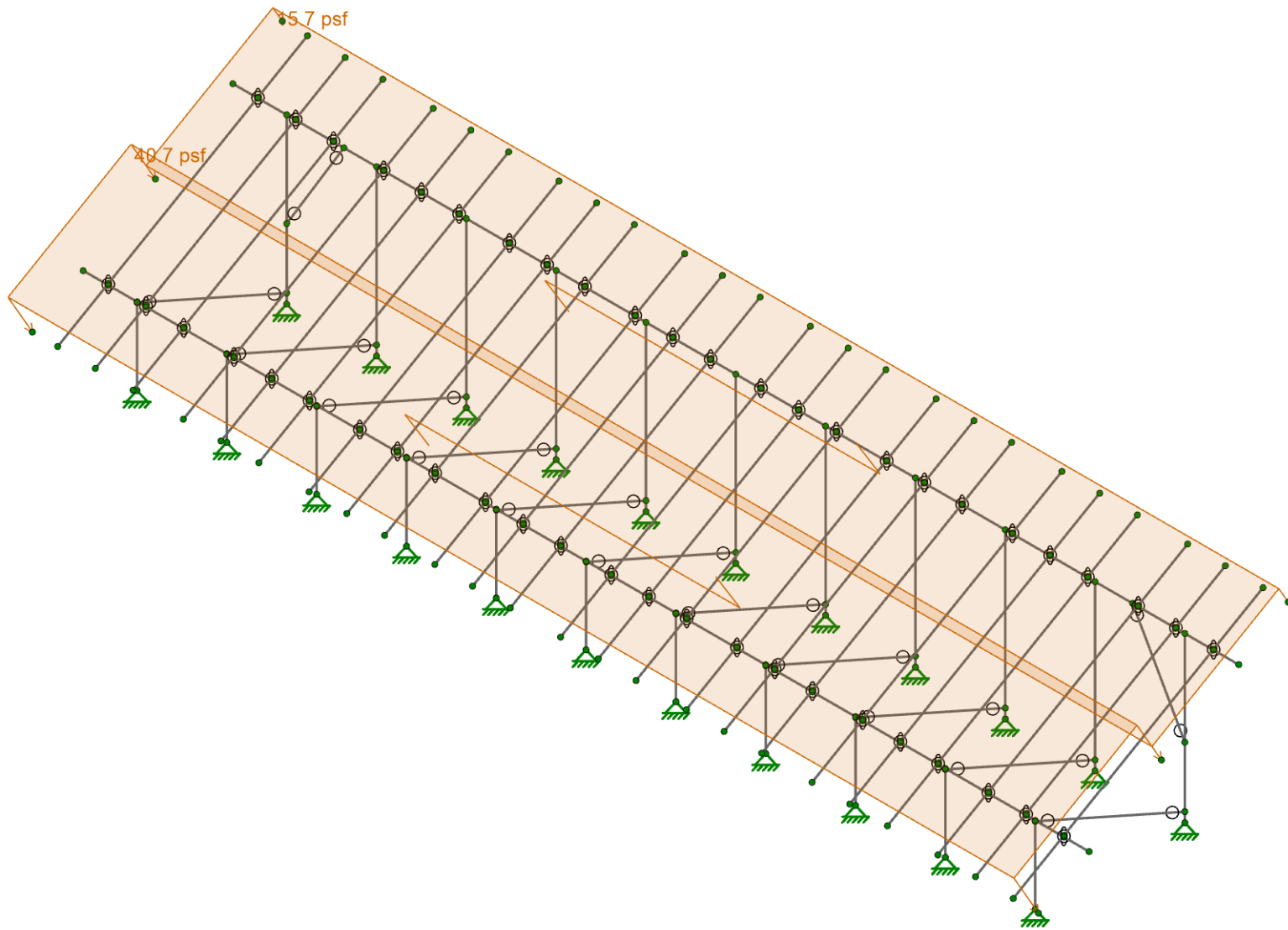
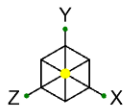

Loads: BLC 7, Wind B 180 deg

Vector Structural Engineering
LKN
U2716.0366.231

Sunturf Ground Mount B7 LF 30°

SK-9
Feb 02, 2023
Sunturf Ground Mount B7 LF 30deg 3R.r3d

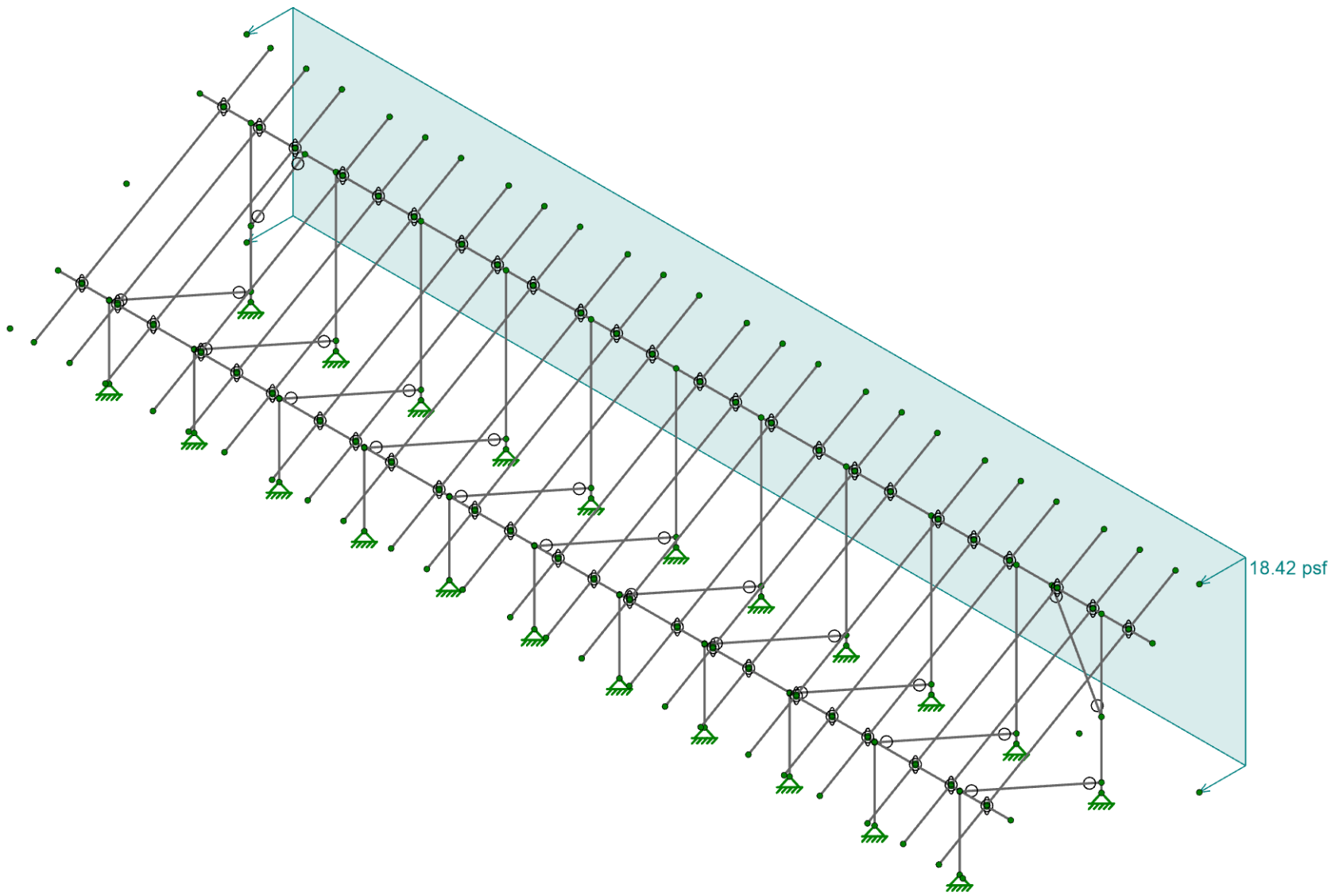
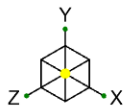

Loads: BLC 8, Wind Z

Vector Structural Engineering
LKN
U2716.0366.231

Sunturf Ground Mount B7 LF 30°

SK-10
Feb 02, 2023
Sunturf Ground Mount B7 LF 30deg 3R.r3d

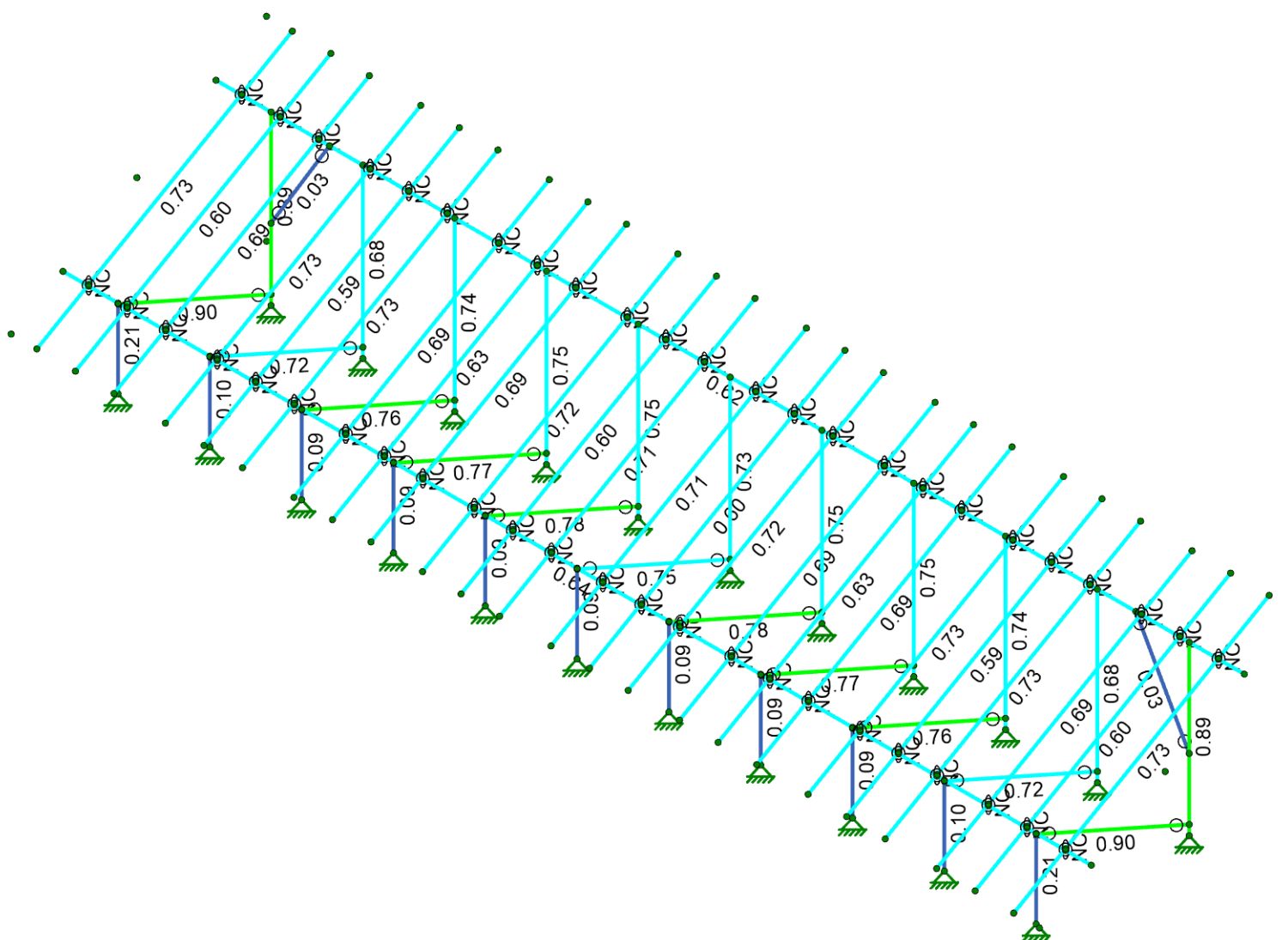
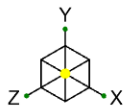

Code Check (Env)	
Black	No Calc
Red	> 1.0
Magenta	.90-1.0
Green	.75-90
Cyan	.50-.75
Blue	0.-.50

Member Code Checks Displayed (Enveloped)		
Vector Structural Engineering	Sunturf Ground Mount B7 LF 30°	SK-11
LKN		Feb 02, 2023
U2716.0366.231		Sunturf Ground Mount B7 LF 30deg 3R.r3d

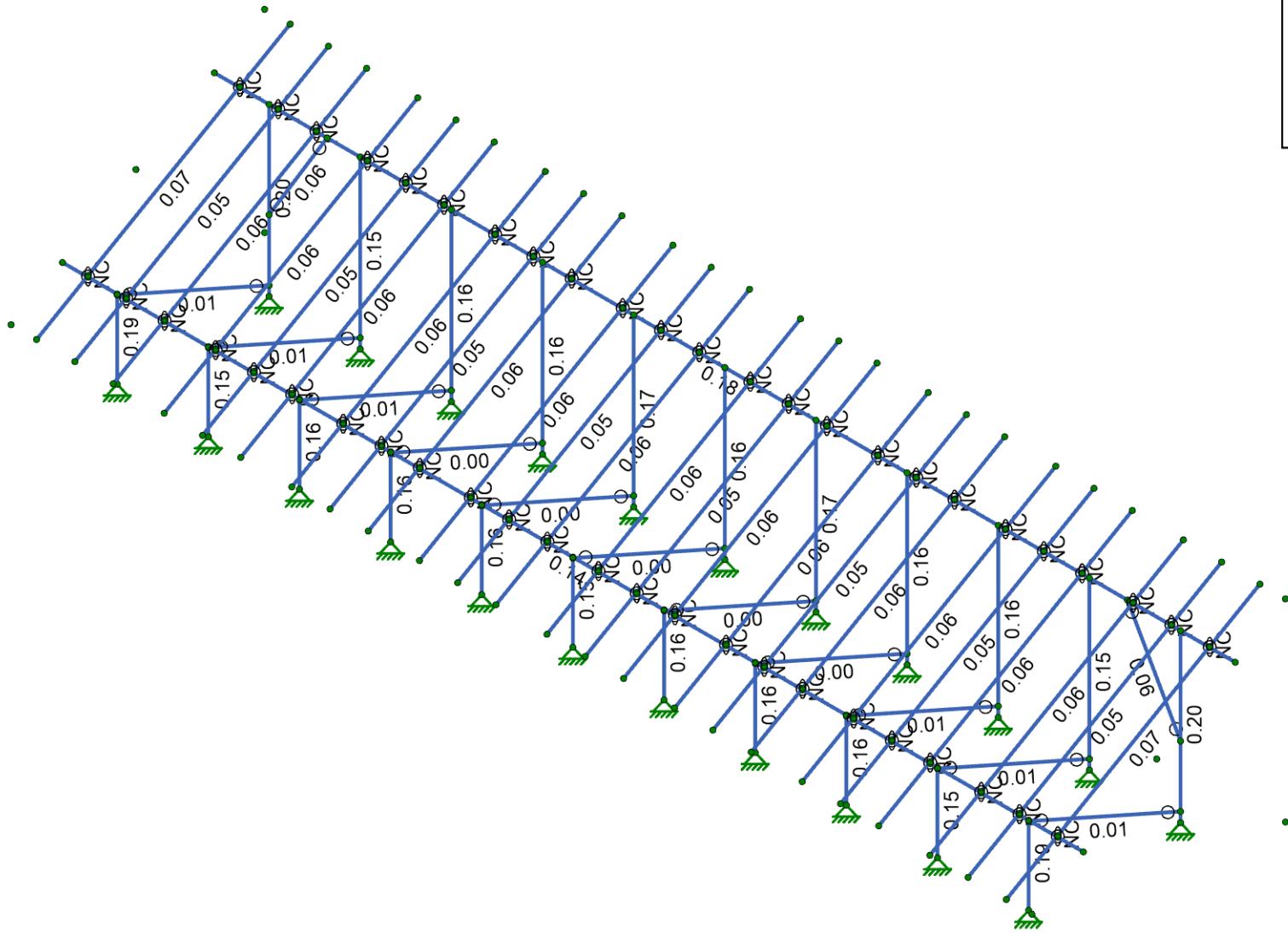
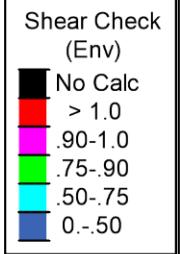
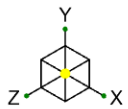

Member Shear Checks Displayed (Enveloped)		
Vector Structural Engineering	Sunturf Ground Mount B7 LF 30°	SK-12
LKN		Feb 02, 2023
U2716.0366.231		Sunturf Ground Mount B7 LF 30deg 3R.r3d

Model Settings

Number of Reported Sections	5
Number of Internal Sections	100
Member Area Load Mesh Size (in ²)	144
Consider Shear Deformation	Yes
Consider Torsional Warping	Yes
Approximate Mesh Size (in)	24
Transfer Forces Between Intersecting Wood Walls	Yes
Increase Wood Wall Nailing Capacity for Wind Loads	Yes
Include P-Delta for Walls	Yes
Optimize Masonry and Wood Walls	Yes
Maximum Number of Iterations	3
Single	No
Multiple (Optimum)	Yes
Maximum	No

Global Axis corresponding to vertical direction	Y
Convert Existing Data	Yes
Default Global Plane for z-axis	XZ
Plate Local Axis Orientation	Nodal

Hot Rolled Steel	AISC 15th (360-16): ASD
Stiffness Adjustment	Yes (Iterative)
Notional Annex	None
Connections	None
Cold Formed Steel	None
Stiffness Adjustment	Yes (Iterative)
Wood	None
Temperature	< 100F
Concrete	ACI 318-14
Masonry	None
Aluminum	AA ADM1-15: ASD
Structure Type	Building
Stiffness Adjustment	Yes (Iterative)
Stainless	None
Stiffness Adjustment	Yes (Iterative)

Analysis Methodology	Exact Integration Method
Parame Beta Factor	0.65

Compression Stress Block	Rectangular Stress Block
Analyze using Cracked Sections	No
Leave room for horizontal rebar splices (2*d bar spacing)	Yes
List forces which were ignored for design in the Detail Report	Yes

Column Min Steel	1
Column Max Steel	8
Rebar Material Spec	ASTM A615
Warn if beam-column framing arrangement is not understood	No
Number of Shear Regions	4
Region 2 & 3 Spacing Increase Increment (in)	3.999992

Code	None
------	------



Company : Vector Structural Engineering
Designer : LKN
Job Number : U2716.0366.231
Model Name : Sunturf Ground Mount B7 LF 30°

2/7/2023
11:52:57 AM
Checked By : _____

Model Settings (Continued)

Base Elevation (ft)	15600
Include the weight of the structure in base shear calcs	Yes
T Z (sec)	
T X (sec)	
CZ	0.02
CX	0.02
R Z	3
R X	3

Hot Rolled Steel Properties

	Label	E [ksi]	G [ksi]	Nu	Therm. Coeff. [1e ⁵ F ⁻¹]	Density [lb/ft ³]	Yield [psi]	Ry	Fu [psi]	Rt
1	A992	29000	11154	0.3	0.65	490	50000	1.1	65000	1.1
2	A36 Gr.36	29000	11154	0.3	0.65	490	36000	1.5	58000	1.2
3	A572 Gr.50	29000	11154	0.3	0.65	490	50000	1.1	65000	1.1
4	A500 Gr.B RND	29000	11154	0.3	0.65	527	42000	1.4	58000	1.3
5	A500 Gr.B Rect	29000	11154	0.3	0.65	527	46000	1.4	58000	1.3
6	A53 Gr.B	29000	11154	0.3	0.65	490	35000	1.6	60000	1.2
7	A1085	29000	11154	0.3	0.65	490	50000	1.4	65000	1.3

Aluminum Properties

	Label	E [ksi]	G [ksi]	Nu	Therm. Coeff. [1e ⁵ F ⁻¹]	Density [lb/ft ³]	Table B.4	kt	Ftu [psi]	Fty [psi]	Fcy [psi]	Fsu [psi]	Ct
1	3003-H14	10100	3787.5	0.33	1.3	172.8	Table B.4-1	1	19000	16000	13000	12000	141
2	6061-T6	10100	3787.5	0.33	1.3	172.8	Table B.4-2	1	38000	35000	35000	24000	141
3	6063-T5	10100	3787.5	0.33	1.3	172.8	Table B.4-2	1	22000	16000	16000	13000	141
4	6063-T6	10100	3787.5	0.33	1.3	172.8	Table B.4-2	1	30000	25000	25000	19000	141
5	5052-H34	10200	3787.5	0.33	1.3	172.8	Table B.4-1	1	34000	26000	24000	20000	141
6	6061-T6 W	10100	3787.5	0.33	1.3	172.8	Table B.4-1	1	24000	15000	15000	15000	141
7	6005-T5	10100	3787.5	0.33	1.3	172.8	Table B.4-1	1	38000	35000	35000	24000	141

Hot Rolled Steel Section Sets

	Label	Shape	Type	Design List	Material	Design Rule	Area [in ²]	Iyy [in ⁴]	Izz [in ⁴]	J [in ⁴]
1	Post	PIPE2.0A21165	Column	Pipe	A572 Gr.50	Typical	0.776	0.499	0.499	0.998
2	Cross Beam	PIPE2.5A21168	Beam	Wide Flange	A572 Gr.50	Typical	0.947	0.907	0.907	1.814
3	Diagonal Brace	1.5X1.5X0.083	HBrace	SquareTube	A572 Gr.50	Typical	0.47	0.158	0.158	0.236

Aluminum Section Sets

	Label	Shape	Type	Design List	Material	Design Rule	Area [in ²]	Iyy [in ⁴]	Izz [in ⁴]	J [in ⁴]
1	AL Posts	2.375ODX0.188	Column	Pipe	6005-T5	Typical	1.29	0.778	0.778	1.54
2	AL Brace	RT1.5X2X0.15625	VBrace	Rectangular Tubes	6005-T5	Typical	0.996	0.327	0.524	0.602
3	AL Rails	HR300 ALA	Beam	Rectangular Tubes	6005-T5	Typical	0.736	0.214	0.727	0.734
4	AL Cross Beam	CROSSRAIL	Beam	Rectangular Tubes	6005-T5	Typical	1.909	1.97	4.366	4.017

Basic Load Cases

	BLC Description	Category	Y Gravity	Distributed	Area(Member)
1	Self Weight	DL	-1.05		
2	Solar Panel Weight	DL			1
3	Roof Live/Snow	RLL			1
4	Wind A 0 deg	OL1			2
5	Wind B 0 deg	OL2			2
6	Wind A 180 deg	OL3			2
7	Wind B 180 deg	OL4			2
8	Wind Z	WLZ			1
9	BLC 2 Transient Area Loads	None		52	
10	BLC 3 Transient Area Loads	None		52	
11	BLC 4 Transient Area Loads	None		160	
12	BLC 5 Transient Area Loads	None		160	
13	BLC 6 Transient Area Loads	None		160	
14	BLC 7 Transient Area Loads	None		160	
15	BLC 8 Transient Area Loads	None		96	

Member Area Loads (BLC 2 : Solar Panel Weight)

	Node A	Node B	Node C	Node D	Direction	Load Direction	Magnitude [psf]
1	N197	N200	N199	N196	Y	A-B	-3

Member Area Loads (BLC 3 : Roof Live/Snow)

	Node A	Node B	Node C	Node D	Direction	Load Direction	Magnitude [psf]
1	N197	N200	N199	N196	PY	A-B	-22

Member Area Loads (BLC 4 : Wind A 0 deg)

	Node A	Node B	Node C	Node D	Direction	Load Direction	Magnitude [psf]
1	N197	N200	N201	N198	Perp	A-B	-28.2
2	N198	N201	N199	N196	Perp	A-B	-28.2

Member Area Loads (BLC 5 : Wind B 0 deg)

	Node A	Node B	Node C	Node D	Direction	Load Direction	Magnitude [psf]
1	N197	N200	N201	N198	Perp	A-B	-39.1
2	N198	N201	N199	N196	Perp	A-B	-7.8

Member Area Loads (BLC 6 : Wind A 180 deg)

	Node A	Node B	Node C	Node D	Direction	Load Direction	Magnitude [psf]
1	N197	N200	N201	N198	Perp	A-B	32.9
2	N198	N201	N199	N196	Perp	A-B	32.9

Member Area Loads (BLC 7 : Wind B 180 deg)

	Node A	Node B	Node C	Node D	Direction	Load Direction	Magnitude [psf]
1	N197	N200	N201	N198	Perp	A-B	15.7
2	N198	N201	N199	N196	Perp	A-B	40.7

Member Area Loads (BLC 8 : Wind Z)

	Node A	Node B	Node C	Node D	Direction	Load Direction	Magnitude [psf]
1	N200	N197	N269	N270	Z	Open Structure	18.42

Load Combinations

	Description	Solve	P-Delta	BLC	Factor	BLC	Factor	BLC	Factor	BLC	Factor
1	ASD Loads		Y								
2	1.0 D	Yes	Y	DL	1						
3	1.0 D + 1.0 S	Yes	Y	DL	1	RLL	1				
4	1.0 D + 0.6 W1	Yes	Y	DL	1	RLL		OL1	0.6	WLZ	0.6
5	1.0 D + 0.6 W2	Yes	Y	DL	1	RLL		OL2	0.6	WLZ	0.6
6	1.0 D + 0.6 W3	Yes	Y	DL	1	RLL		OL3	0.6	WLZ	-0.6
7	1.0 D + 0.6 W4	Yes	Y	DL	1	RLL		OL4	0.6	WLZ	-0.6
8	1.0 D + 0.45 W1 + 0.75 S	Yes	Y	DL	1	RLL	0.75	OL1	0.45	WLZ	0.45
9	1.0 D + 0.45 W2 + 0.75 S	Yes	Y	DL	1	RLL	0.75	OL2	0.45	WLZ	0.45
10	1.0 D + 0.45 W3 + 0.75 S	Yes	Y	DL	1	RLL	0.75	OL3	0.45	WLZ	-0.45
11	1.0 D + 0.45 W4 + 0.75 S	Yes	Y	DL	1	RLL	0.75	OL4	0.45	WLZ	-0.45
12	0.6 D + 0.6 W1	Yes	Y	DL	0.6	RLL		OL1	0.6	WLZ	0.6
13	0.6 D + 0.6 W2	Yes	Y	DL	0.6	RLL		OL2	0.6	WLZ	0.6

Load Combinations (Continued)

	Description	Solve	P-Delta	BLC	Factor	BLC	Factor	BLC	Factor	BLC	Factor
14	0.6 D + 0.6 W3	Yes	Y	DL	0.6	RLL		OL3	0.6	WLZ	-0.6
15	0.6 D + 0.6 W4	Yes	Y	DL	0.6	RLL		OL4	0.6	WLZ	-0.6
16			Y								
17	LRFD Loads		Y								
18	1.4 D		Y	DL	1.4	RLL					
19	1.2 D + 1.6 S + 0.5 W1		Y	DL	1.2	RLL	1.6	OL1	0.5	WLZ	0.5
20	1.2 D + 1.6 S + 0.5 W2		Y	DL	1.2	RLL	1.6	OL2	0.5	WLZ	0.5
21	1.2 D + 1.6 S + 0.5 W3		Y	DL	1.2	RLL	1.6	OL3	0.5	WLZ	-0.5
22	1.2 D + 1.6 S + 0.5 W4		Y	DL	1.2	RLL	1.6	OL4	0.5	WLZ	-0.5
23	1.2 D + 1.0 W1		Y	DL	1.2	RLL		OL1	1	WLZ	1
24	1.2 D + 1.0 W2		Y	DL	1.2	RLL		OL2	1	WLZ	1
25	1.2 D + 1.0 W3		Y	DL	1.2	RLL		OL3	1	WLZ	-1
26	1.2 D + 1.0 W4		Y	DL	1.2	RLL		OL4	1	WLZ	-1
27	0.9 D + 1.0 W1		Y	DL	0.9	RLL		OL1	1	WLZ	1
28	0.9 D + 1.0 W2		Y	DL	0.9	RLL		OL2	1	WLZ	1
29	0.9 D + 1.0 W3		Y	DL	0.9	RLL		OL3	1	WLZ	-1
30	0.9 D + 1.0 W4		Y	DL	0.9	RLL		OL4	1	WLZ	-1

Envelope Node Reactions

	Node Label		X [lb]	LC	Y [lb]	LC	Z [lb]	LC	MX [lb-ft]	LC	MY [lb-ft]	LC	MZ [lb-ft]	LC
1	N2	max	18.627	12	1453.443	9	7.558	8	0	15	0	15	0	15
2		min	-46.3	11	134.976	14	-9.062	10	0	2	0	2	0	2
3	N1	max	13.838	10	2588.464	10	1221.171	6	0	15	0	15	0	15
4		min	-9.616	13	-1799.335	13	-1069.067	4	0	2	0	2	0	2
5	N109	max	0.827	13	2159.406	10	1056.453	6	0	15	0	15	0	15
6		min	-1.215	10	-1519.101	13	-915.679	4	0	2	0	2	0	2
7	N110A	max	-0.067	14	1250.53	9	6.96	8	0	15	0	15	0	15
8		min	-3.065	9	119.173	14	-9.138	10	0	2	0	2	0	2
9	N237	max	1.057	10	2177.027	10	1064.869	6	0	15	0	15	0	15
10		min	-0.566	13	-1539.17	13	-924.781	4	0	2	0	2	0	2
11	N239	max	4.368	11	1263.735	9	6.917	8	0	15	0	15	0	15
12		min	-2.144	12	107.07	14	-8.925	10	0	2	0	2	0	2
13	N244	max	0.02	15	2120.052	10	1028.239	6	0	15	0	15	0	15
14		min	-0.076	13	-1479.759	13	-891.805	4	0	2	0	2	0	2
15	N246	max	0.028	6	1218.19	9	6.917	8	0	15	0	15	0	15
16		min	-0.004	3	108.181	12	-9.122	10	0	2	0	2	0	2
17	N250	max	3.086	9	1250.517	9	6.961	8	0	15	0	15	0	15
18		min	0.121	14	119.156	14	-9.14	10	0	2	0	2	0	2
19	N253	max	0.411	13	2177.08	10	1064.879	6	0	15	0	15	0	15
20		min	-1.088	10	-1539.21	13	-924.794	4	0	2	0	2	0	2
21	N255	max	2.169	12	1263.719	9	6.917	8	0	15	0	15	0	15
22		min	-4.354	11	107.066	14	-8.926	10	0	2	0	2	0	2
23	N257	max	1.179	10	2159.154	10	1056.517	6	0	15	0	15	0	15
24		min	-0.975	13	-1518.915	13	-915.706	4	0	2	0	2	0	2
25	N264	max	46.383	11	1453.603	9	7.56	8	0	15	0	15	0	15
26		min	-18.645	12	134.454	14	-9.058	10	0	2	0	2	0	2
27	N268	max	5.224	12	1147.269	9	7.78	8	0	15	0	15	0	15
28		min	-17.837	11	100.686	14	-11.207	10	0	2	0	2	0	2
29	N275	max	3.526	13	1921.409	10	990.653	6	0	15	0	15	0	15
30		min	-6.187	10	-1352.966	13	-841.669	4	0	2	0	2	0	2
31	N281	max	10.035	13	2589.527	10	1221.388	6	0	15	0	15	0	15
32		min	-13.963	10	-1801.041	13	-1069.197	4	0	2	0	2	0	2
33	N71	max	9.371	11	1248.625	9	6.913	8	0	15	0	15	0	15
34		min	-1.923	12	116.897	12	-9.657	10	0	2	0	2	0	2
35	N73	max	3.366	10	2173.655	10	1040.127	14	0	15	0	15	0	15

Envelope Node Reactions (Continued)

Node Label		X [lb]	LC	Y [lb]	LC	Z [lb]	LC	MX [lb-ft]	LC	MY [lb-ft]	LC	MZ [lb-ft]	LC	
36		min	-2.224	13	-1531.313	13	-912.209	4	0	2	0	2	0	2
37	N161	max	2.05	13	2172.019	10	1039.946	14	0	15	0	15	0	15
38		min	-3.37	10	-1530.155	13	-912.051	4	0	2	0	2	0	2
39	N163	max	1.946	12	1248.484	9	6.913	8	0	15	0	15	0	15
40		min	-9.352	11	116.712	12	-9.659	10	0	2	0	2	0	2
41	N179	max	6.066	10	1924.468	10	991.1	6	0	15	0	15	0	15
42		min	-3.585	13	-1355.636	13	-841.976	4	0	2	0	2	0	2
43	N181	max	17.802	11	1147.564	9	7.779	8	0	15	0	15	0	15
44		min	-5.172	12	99.987	14	-11.198	10	0	2	0	2	0	2
45	Totals:	max	0	12	34237.966	10	11691.268	14						
46		min	-0.001	10	-13107.884	12	-10156.734	12						

Envelope AISC 15TH (360-16): ASD Member Steel Code Checks

Member	Shape	Code Check	Loc[in]	LC	Shear	Check	Loc[in]	Dir	LC	Pnc/om [lb]	Pnt/om [lb]	Mnny/om [lb-ft]	Mnzz/om [lb-ft]	Cb	Eqn
1	M133	1.5X1.5X0.083	0.898	62.702	6	0.012	120.387	y	11	1638.339	14085.15	624.421	624.421	1.136	H1-1a
2	M15	1.5X1.5X0.083	0.898	62.702	6	0.012	120.387	y	11	1638.33	14085.15	624.421	624.421	1.136	H1-1a
3	M132	PIPE2.0A21165	0.886	6.27	6	0.196	1.254		6	5177.033	23232.186	1397.505	1397.505	1	H1-1a
4	M6	PIPE2.0A21165	0.886	6.27	6	0.196	1.254		6	5177.033	23232.186	1397.505	1397.505	1	H1-1a
5	M121	1.5X1.5X0.083	0.78	62.702	6	0.004	120.387	y	10	1638.339	14085.15	624.421	624.421	1.136	H1-1a
6	M112	1.5X1.5X0.083	0.78	62.702	6	0.005	120.387	y	10	1638.339	14085.15	624.421	624.421	1.136	H1-1a
7	M118	1.5X1.5X0.083	0.774	62.702	6	0.003	120.387	y	9	1638.339	14085.15	624.421	624.421	1.136	H1-1a
8	M52	1.5X1.5X0.083	0.773	62.702	6	0.003	120.387	y	9	1638.339	14085.15	624.421	624.421	1.136	H1-1a
9	M32	1.5X1.5X0.083	0.761	62.702	6	0.006	120.387	y	10	1638.339	14085.15	624.421	624.421	1.136	H1-1a
10	M82	1.5X1.5X0.083	0.761	62.702	6	0.005	120.387	y	11	1638.339	14085.15	624.421	624.421	1.136	H1-1a
11	M116	1.5X1.5X0.083	0.753	62.702	6	0.002	120.387	y	10	1638.339	14085.15	624.421	624.421	1.136	H1-1a
12	M120	PIPE2.0A21165	0.752	6.27	6	0.166	1.254		6	5177.033	23232.186	1397.505	1397.505	1	H1-1a
13	M114	PIPE2.0A21165	0.752	6.27	6	0.166	1.254		6	5177.033	23232.186	1397.505	1397.505	1	H1-1a
14	M51	PIPE2.0A21165	0.745	6.27	6	0.165	1.254		6	5177.033	23232.186	1397.505	1397.505	1	H1-1a
15	M123	PIPE2.0A21165	0.745	6.27	6	0.165	1.254		6	5177.033	23232.186	1397.505	1397.505	1	H1-1a
16	M34	PIPE2.0A21165	0.74	6.27	6	0.162	1.254		6	5177.033	23232.186	1397.505	1397.505	1	H1-1a
17	M81	PIPE2.0A21165	0.74	6.27	6	0.162	1.254		6	5177.033	23232.186	1397.505	1397.505	1	H1-1a
18	M115	PIPE2.0A21165	0.727	6.27	6	0.16	1.254		6	5177.033	23232.186	1397.505	1397.505	1	H1-1a
19	M91	1.5X1.5X0.083	0.723	62.702	6	0.01	120.387	y	10	1638.339	14085.15	624.421	624.421	1.136	H1-1a
20	M124	1.5X1.5X0.083	0.723	62.702	6	0.009	120.387	y	10	1638.339	14085.15	624.421	624.421	1.136	H1-1a
21	M89	PIPE2.0A21165	0.684	6.27	6	0.154	1.254		6	5177.033	23232.186	1397.505	1397.505	1	H1-1a
22	M129	PIPE2.0A21165	0.683	6.27	6	0.153	1.254		6	5177.033	23232.186	1397.505	1397.505	1	H1-1a
23	M72	PIPE2.5A21168	0.637	700.738	11	0.138	693.038		11	20336.2	28358.413	2081.747	2081.747	1	H1-1b
24	M71	PIPE2.5A21168	0.617	38.502	10	0.184	46.203		10	20336.2	28358.413	2081.747	2081.747	1	H1-1b
25	M134	PIPE2.0A21165	0.212	56.469	11	0.187	56.469		6	16169.465	23232.186	1397.505	1397.505	1	H1-1b
26	M5	PIPE2.0A21165	0.212	56.469	11	0.187	56.469		6	16169.465	23232.186	1397.505	1397.505	1	H1-1b
27	M125	PIPE2.0A21165	0.104	56.469	11	0.148	56.469		6	16169.465	23232.186	1397.505	1397.505	1	H1-1b
28	M90	PIPE2.0A21165	0.104	56.469	11	0.148	56.469		6	16169.465	23232.186	1397.505	1397.505	1	H1-1b
29	M80	PIPE2.0A21165	0.091	56.469	11	0.156	56.469		6	16169.465	23232.186	1397.505	1397.505	1	H1-1b*
30	M33	PIPE2.0A21165	0.091	56.469	11	0.156	56.469		6	16169.465	23232.186	1397.505	1397.505	1	H1-1b*
31	M50	PIPE2.0A21165	0.09	56.469	11	0.159	56.469		6	16169.465	23232.186	1397.505	1397.505	1	H1-1b*
32	M119	PIPE2.0A21165	0.09	56.469	11	0.159	56.469		6	16169.465	23232.186	1397.505	1397.505	1	H1-1b*
33	M113	PIPE2.0A21165	0.09	56.469	11	0.16	56.469		6	16169.465	23232.186	1397.505	1397.505	1	H1-1b*
34	M122	PIPE2.0A21165	0.09	56.469	11	0.16	56.469		6	16169.465	23232.186	1397.505	1397.505	1	H1-1b*
35	M117	PIPE2.0A21165	0.089	56.469	11	0.154	56.469		6	16169.465	23232.186	1397.505	1397.505	1	H1-1b*
36	M75B	1.5X1.5X0.083	0.034	79.124	10	0.059	79.124	y	6	3792.647	14085.15	624.421	624.421	1.136	H1-1b*
37	M19	1.5X1.5X0.083	0.033	80.945	10	0.06	80.945	y	6	3623.984	14085.15	624.421	624.421	1.136	H1-1b*

Envelope AA ADM1-15: ASD - BUILDING Member Aluminum Code Checks

Member	Shape	Code Check	Loc[in]	LC Shear Check	Loc[in]	Dir	LC Pnc/Om[lb]	Pnt/Om[lb]	Mny/Om[lb-ft]	Mnz/Om[lb-ft]	Vny/Om[lb]	Vnz/Om[lb]	Cb	Eqn		
1	M43	HR300 ALA	0.73	106	10	0.061	44.167	y	112314.016	14342.564	533.921	934.619	7307.692	3206.154	1.607	H.1-1
2	M74	HR300 ALA	0.73	106	10	0.061	44.167	y	112314.016	14342.564	533.921	934.619	7307.692	3206.154	1.607	H.1-1
3	M73	HR300 ALA	0.728	103.792	10	0.065	44.167	y	112314.016	14342.564	533.921	934.619	7307.692	3206.154	1.702	H.1-1
4	M83	HR300 ALA	0.728	103.792	10	0.065	44.167	y	112314.016	14342.564	533.921	934.619	7307.692	3206.154	1.702	H.1-1
5	M75	HR300 ALA	0.727	106	10	0.061	44.167	y	112314.016	14342.564	533.921	934.619	7307.692	3206.154	1.604	H.1-1
6	M40	HR300 ALA	0.727	106	10	0.061	44.167	y	112314.016	14342.564	533.921	934.619	7307.692	3206.154	1.604	H.1-1
7	M60	HR300 ALA	0.722	106	10	0.061	44.167	y	112314.016	14342.564	533.921	934.619	7307.692	3206.154	1.601	H.1-1
8	M55	HR300 ALA	0.722	106	10	0.061	44.167	y	112314.016	14342.564	533.921	934.619	7307.692	3206.154	1.601	H.1-1
9	M59	HR300 ALA	0.712	106	10	0.062	44.167	y	112314.016	14342.564	533.921	934.619	7307.692	3206.154	1.593	H.1-1
10	M58	HR300 ALA	0.712	106	10	0.062	44.167	y	112314.016	14342.564	533.921	934.619	7307.692	3206.154	1.593	H.1-1
11	M49	HR300 ALA	0.688	106	10	0.062	44.167	y	112314.016	14342.564	533.921	934.619	7307.692	3206.154	1.581	H.1-1
12	M65	HR300 ALA	0.688	106	10	0.062	44.167	y	112314.016	14342.564	533.921	934.619	7307.692	3206.154	1.581	H.1-1
13	M84	HR300 ALA	0.686	106	10	0.062	44.167	y	112314.016	14342.564	533.921	934.619	7307.692	3206.154	1.577	H.1-1
14	M37	HR300 ALA	0.686	106	10	0.062	44.167	y	112314.016	14342.564	533.921	934.619	7307.692	3206.154	1.578	H.1-1
15	M46	HR300 ALA	0.686	106	10	0.061	44.167	y	112314.016	14342.564	533.921	934.619	7307.692	3206.154	1.577	H.1-1
16	M66	HR300 ALA	0.686	106	10	0.061	44.167	y	112314.016	14342.564	533.921	934.619	7307.692	3206.154	1.577	H.1-1
17	M128	HR300 ALA	0.63	106	10	0.053	44.167	y	112314.016	14342.564	533.921	934.619	7307.692	3206.154	1.609	H.1-1
18	M111	HR300 ALA	0.63	106	10	0.053	44.167	y	112314.016	14342.564	533.921	934.619	7307.692	3206.154	1.609	H.1-1
19	M126	HR300 ALA	0.603	106	10	0.053	44.167	y	112314.016	14342.564	533.921	934.619	7307.692	3206.154	1.585	H.1-1
20	M127	HR300 ALA	0.603	106	10	0.053	44.167	y	112314.016	14342.564	533.921	934.619	7307.692	3206.154	1.585	H.1-1
21	M93	HR300 ALA	0.597	103.792	10	0.054	44.167	y	112314.016	14342.564	533.921	934.619	7307.692	3206.154	1.593	H.1-1
22	M94	HR300 ALA	0.597	103.792	10	0.054	44.167	y	112314.016	14342.564	533.921	934.619	7307.692	3206.154	1.593	H.1-1
23	M110	HR300 ALA	0.586	106	10	0.053	44.167	y	112314.016	14342.564	533.921	934.619	7307.692	3206.154	1.57	H.1-1
24	M130	HR300 ALA	0.586	106	10	0.053	44.167	y	112314.016	14342.564	533.921	934.619	7307.692	3206.154	1.57	H.1-1

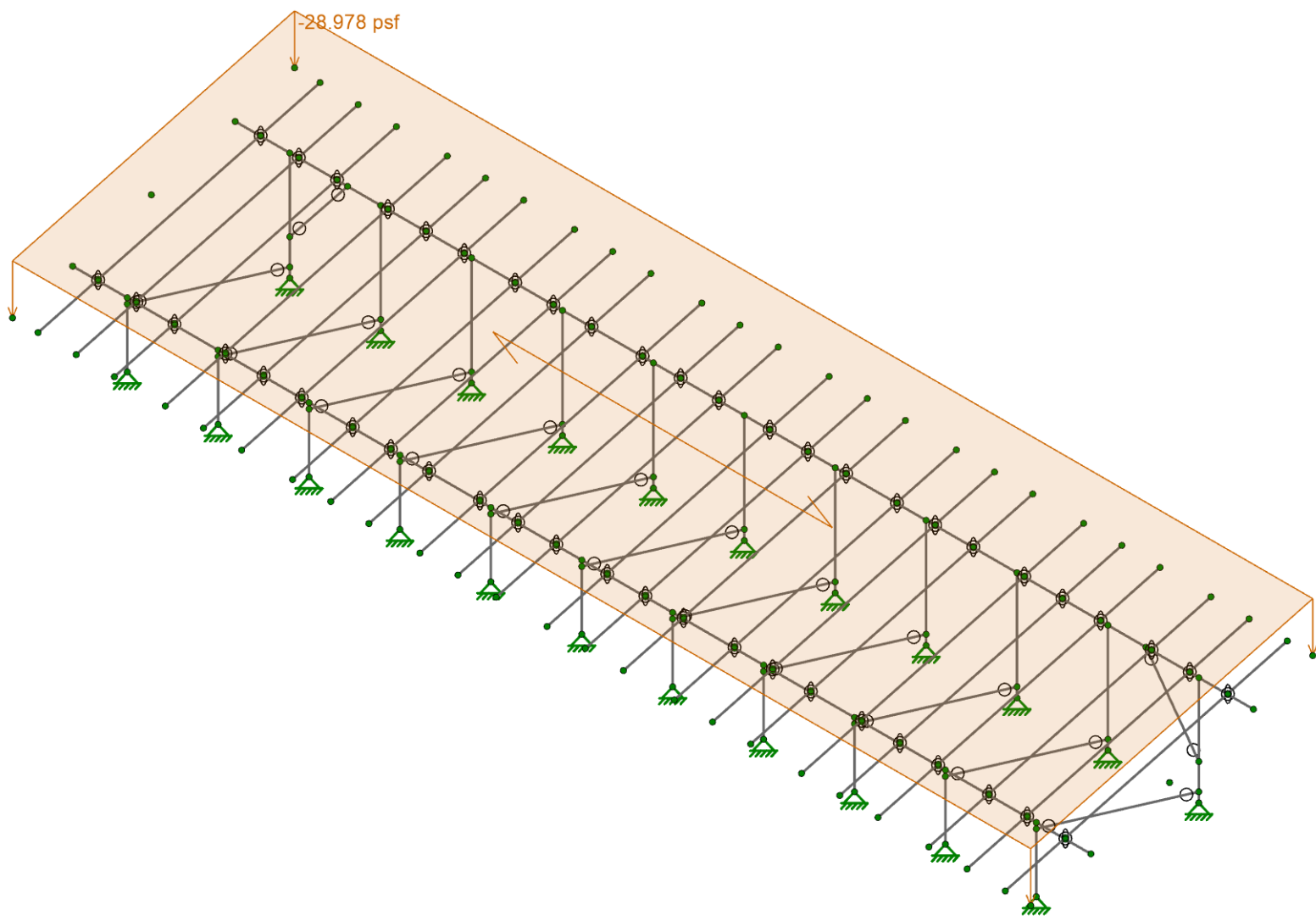
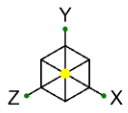

Loads: BLC 3, Roof Live/Snow

Vector Structural Engineering
LKN
U2716.0366.231

Sunturf Ground Mount B7 LF 15°

SK-1
Feb 02, 2023
Sunturf Ground Mount B7 LF 15deg 3R.r3d

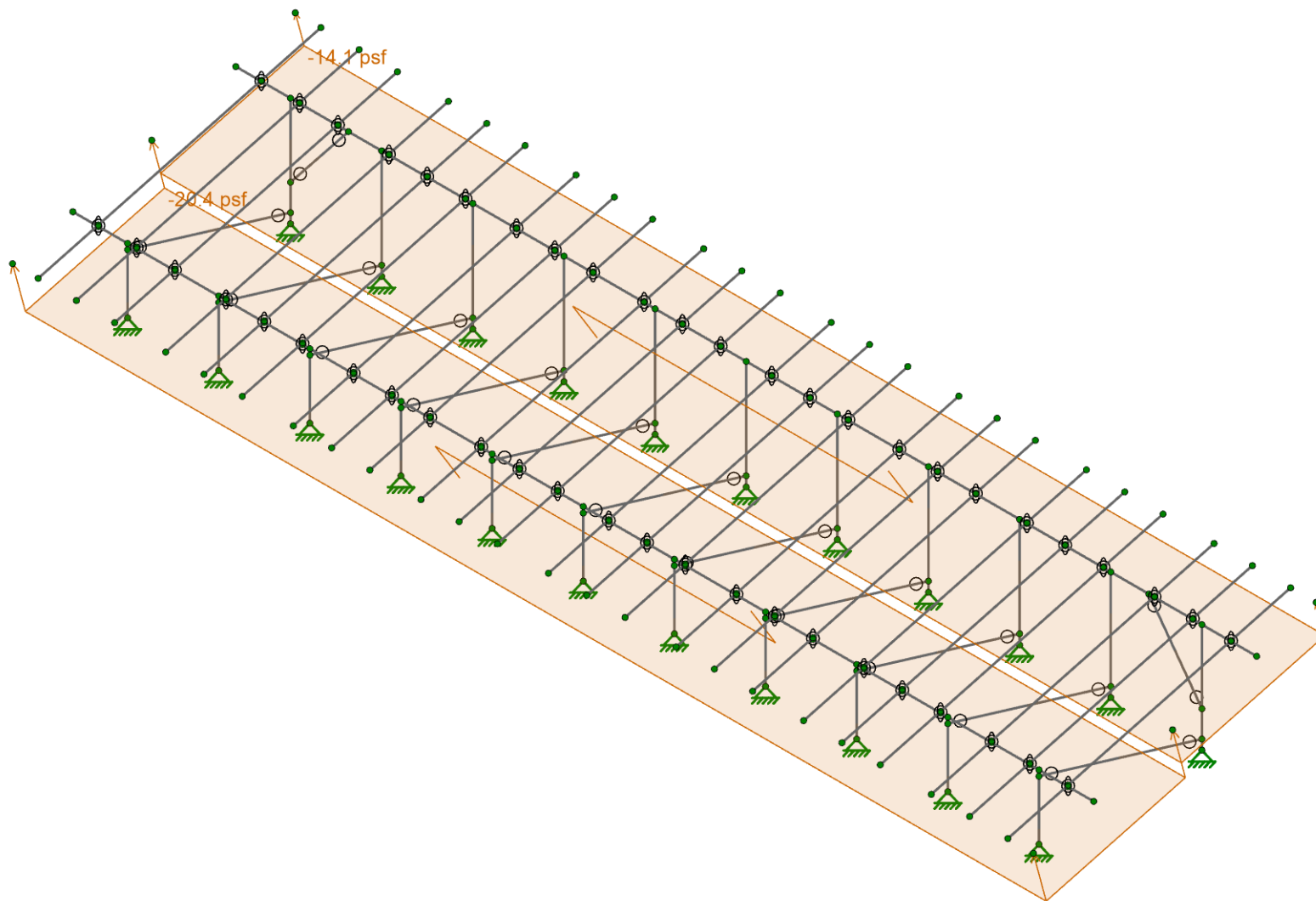
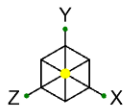

Loads: BLC 4, Wind A 0 deg

Vector Structural Engineering
LKN
U2716.0366.231

Sunturf Ground Mount B7 LF 15°

SK-2
Feb 02, 2023
Sunturf Ground Mount B7 LF 15deg 3R.r3d

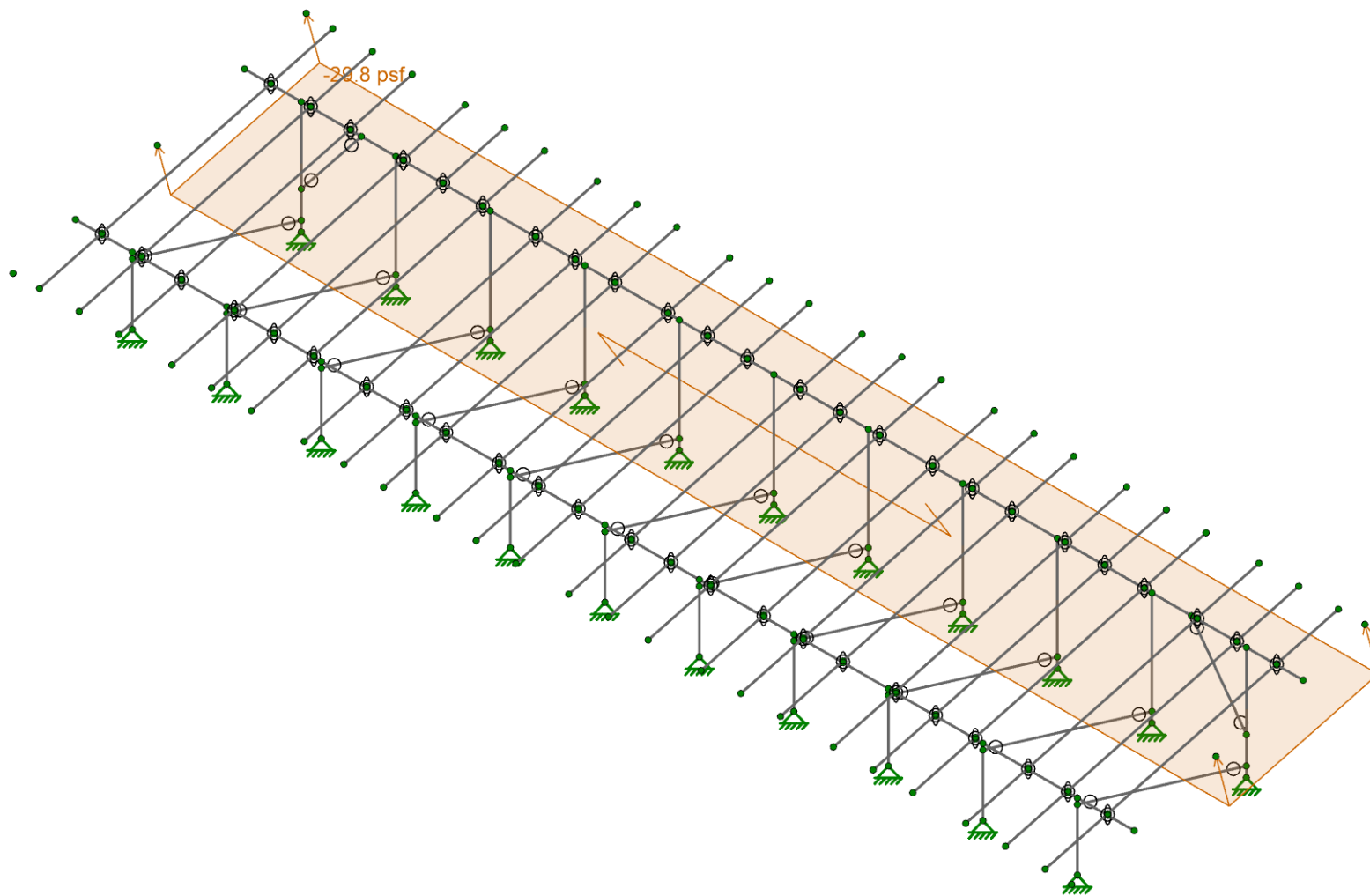
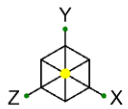

Loads: BLC 5, Wind B 0 deg

Vector Structural Engineering
LKN
U2716.0366.231

Sunturf Ground Mount B7 LF 15°

SK-3
Feb 02, 2023
Sunturf Ground Mount B7 LF 15deg 3R.r3d

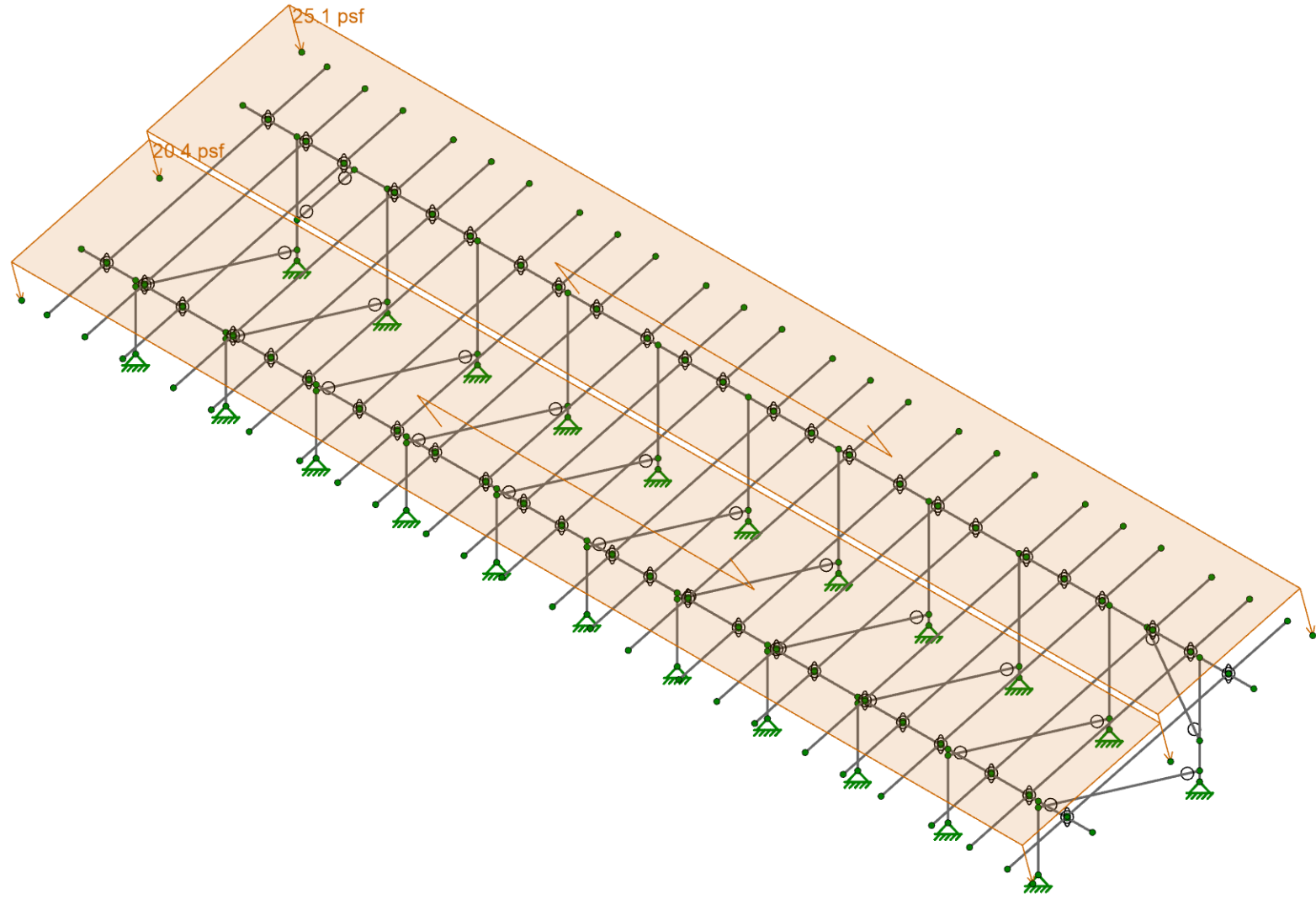
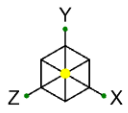

Loads: BLC 6, Wind A 180 deg

Vector Structural Engineering
LKN
U2716.0366.231

Sunturf Ground Mount B7 LF 15°

SK-4
Feb 02, 2023
Sunturf Ground Mount B7 LF 15deg 3R.r3d

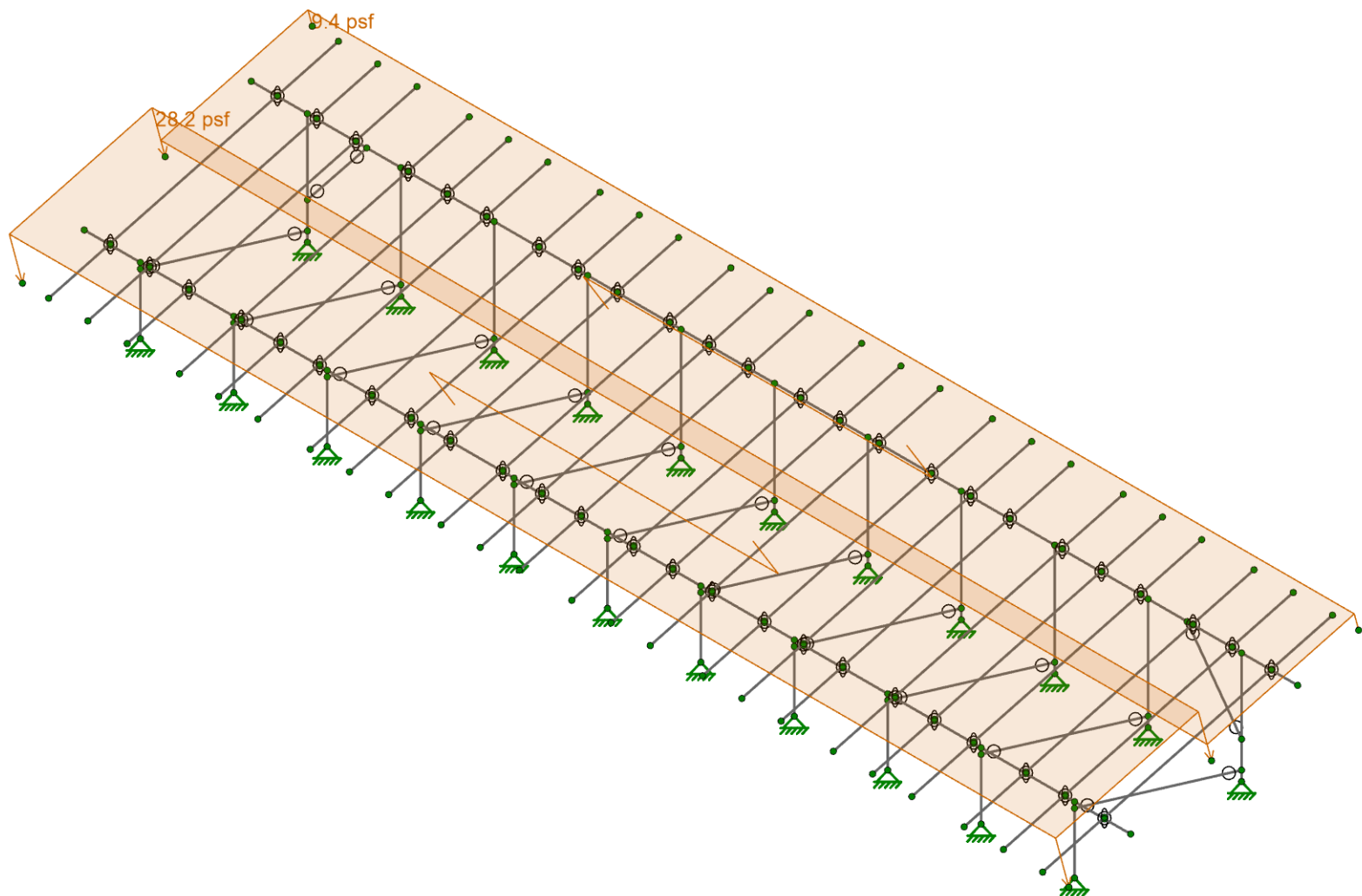
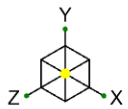

Loads: BLC 7, Wind B 180 deg

Vector Structural Engineering
LKN
U2716.0366.231

Sunturf Ground Mount B7 LF 15°

SK-5
Feb 02, 2023
Sunturf Ground Mount B7 LF 15deg 3R.r3d

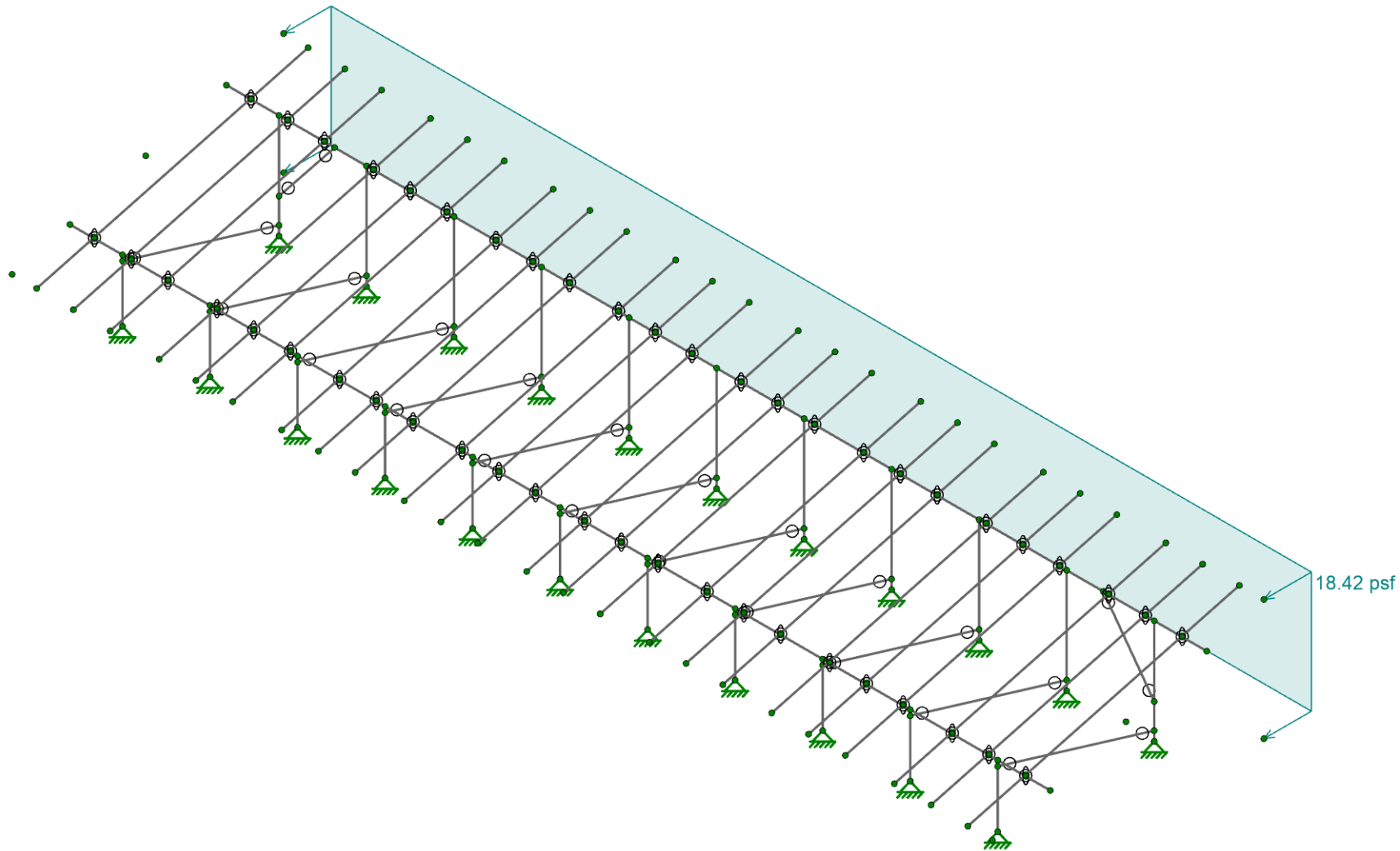
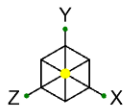

Loads: BLC 8, Wind Z

Vector Structural Engineering
LKN
U2716.0366.231

Sunturf Ground Mount B7 LF 15°

SK-6
Feb 02, 2023
Sunturf Ground Mount B7 LF 15deg 3R.r3d

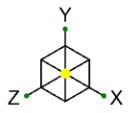

Code Check (Env)

- No Calc
- > 1.0
- .90-1.0
- .75-.90
- .50-.75
- 0.-.50

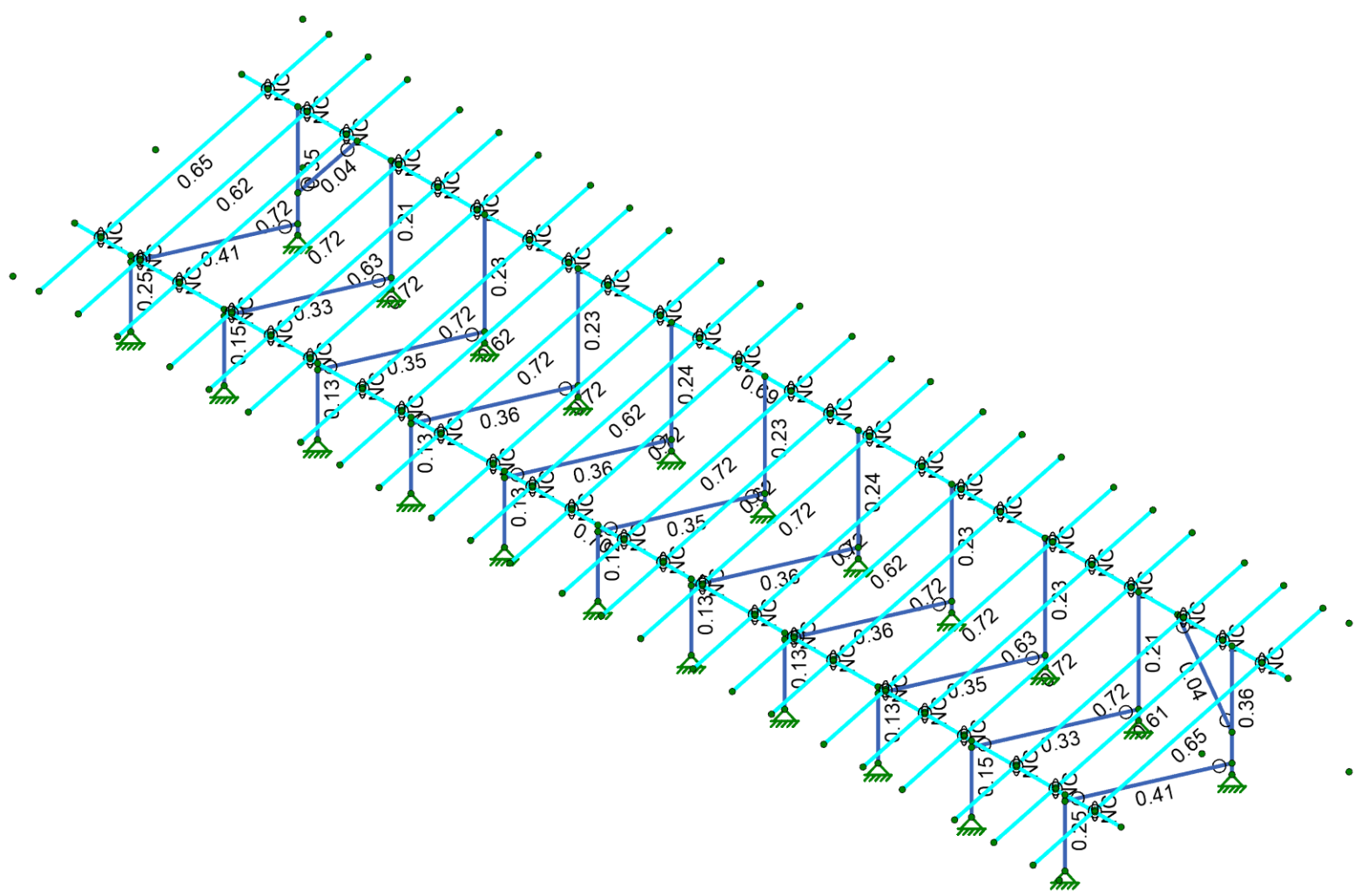

Member Code Checks Displayed (Enveloped)		
Vector Structural Engineering	Sunturf Ground Mount B7 LF 15°	SK-7
LKN		Feb 02, 2023
U2716.0366.231		Sunturf Ground Mount B7 LF 15deg 3R.r3d

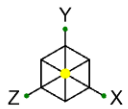

Shear Check (Env)

- No Calc
- > 1.0
- .90-1.0
- .75-90
- .50-75
- 0.-.50

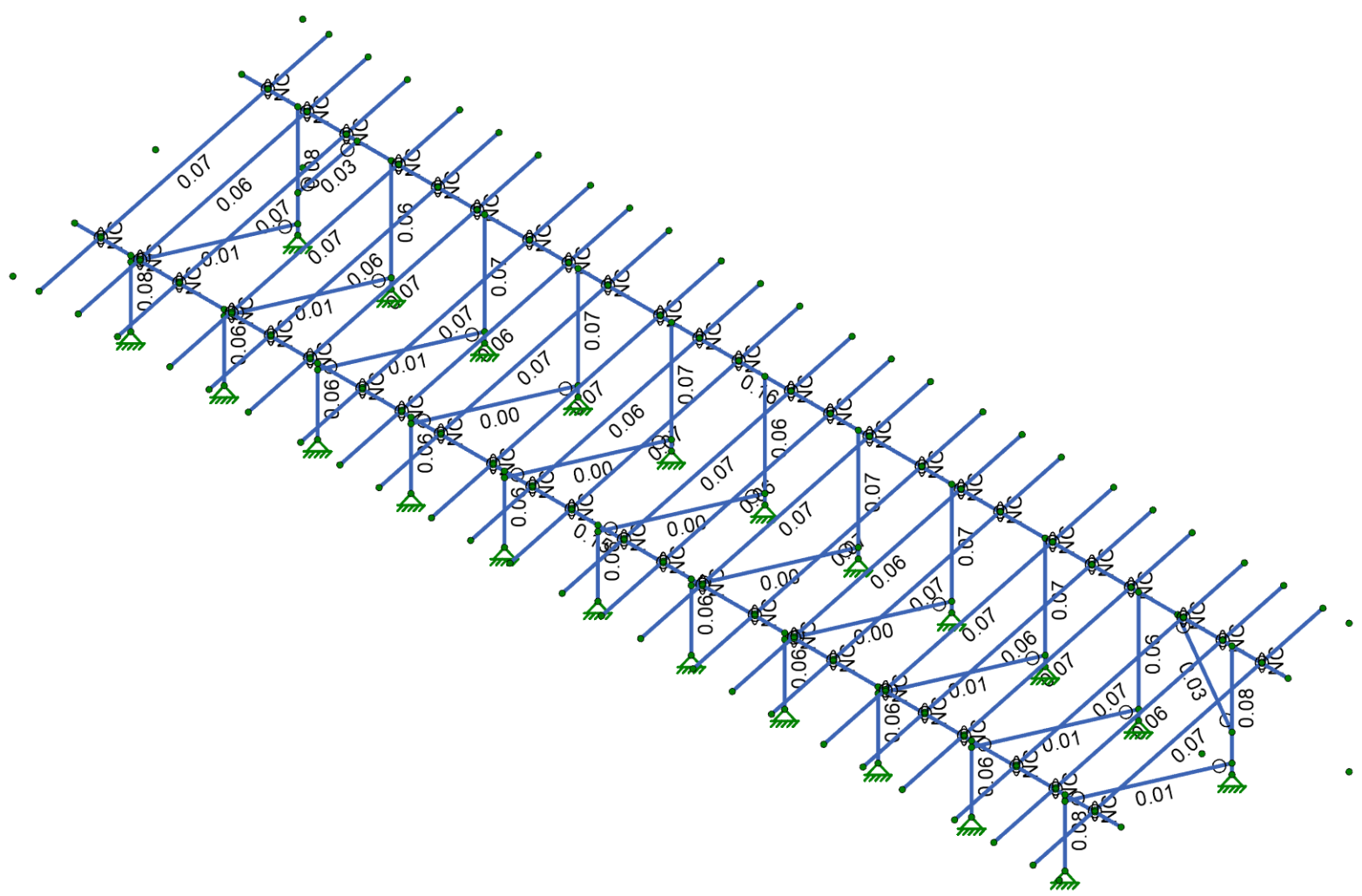

Member Shear Checks Displayed (Enveloped)		
Vector Structural Engineering	Sunturf Ground Mount B7 LF 15°	SK-8
LKN		Feb 02, 2023
U2716.0366.231		Sunturf Ground Mount B7 LF 15deg 3R.r3d

Basic Load Cases

	BLC Description	Category	Y Gravity	Distributed	Area(Member)
1	Self Weight	DL	-1.05		
2	Solar Panel Weight	DL			1
3	Roof Live/Snow	RLL			1
4	Wind A 0 deg	OL1			2
5	Wind B 0 deg	OL2			2
6	Wind A 180 deg	OL3			2
7	Wind B 180 deg	OL4			2
8	Wind Z	WLZ			1
9	BLC 2 Transient Area Loads	None		52	
10	BLC 3 Transient Area Loads	None		52	
11	BLC 4 Transient Area Loads	None		160	
12	BLC 5 Transient Area Loads	None		80	
13	BLC 6 Transient Area Loads	None		160	
14	BLC 7 Transient Area Loads	None		160	
15	BLC 8 Transient Area Loads	None		96	

Member Area Loads (BLC 2 : Solar Panel Weight)

	Node A	Node B	Node C	Node D	Direction	Load Direction	Magnitude [psf]
1	N197	N200	N199	N196	Y	A-B	-3

Member Area Loads (BLC 3 : Roof Live/Snow)

	Node A	Node B	Node C	Node D	Direction	Load Direction	Magnitude [psf]
1	N197	N200	N199	N196	PY	A-B	-30

Member Area Loads (BLC 4 : Wind A 0 deg)

	Node A	Node B	Node C	Node D	Direction	Load Direction	Magnitude [psf]
1	N197	N200	N201	N198	Perp	A-B	-14.1
2	N198	N201	N199	N196	Perp	A-B	-20.4

Member Area Loads (BLC 5 : Wind B 0 deg)

	Node A	Node B	Node C	Node D	Direction	Load Direction	Magnitude [psf]
1	N197	N200	N201	N198	Perp	A-B	-29.8
2	N198	N201	N199	N196	Perp	A-B	0

Member Area Loads (BLC 6 : Wind A 180 deg)

	Node A	Node B	Node C	Node D	Direction	Load Direction	Magnitude [psf]
1	N197	N200	N201	N198	Perp	A-B	25.1
2	N198	N201	N199	N196	Perp	A-B	20.4

Member Area Loads (BLC 7 : Wind B 180 deg)

	Node A	Node B	Node C	Node D	Direction	Load Direction	Magnitude [psf]
1	N197	N200	N201	N198	Perp	A-B	9.4
2	N198	N201	N199	N196	Perp	A-B	28.2

Member Area Loads (BLC 8 : Wind Z)

	Node A	Node B	Node C	Node D	Direction	Load Direction	Magnitude [psf]
1	N200	N197	N269	N270	Z	Open Structure	18.42

Load Combinations

	Description	Solve	P-Delta	BLC	Factor	BLC	Factor	BLC	Factor	BLC	Factor
1	ASD Loads		Y								
2	1.0 D	Yes	Y	DL	1						
3	1.0 D + 1.0 S	Yes	Y	DL	1	RLL	1				
4	1.0 D + 0.6 W1	Yes	Y	DL	1	RLL		OL1	0.6	WLZ	0.6
5	1.0 D + 0.6 W2	Yes	Y	DL	1	RLL		OL2	0.6	WLZ	0.6
6	1.0 D + 0.6 W3	Yes	Y	DL	1	RLL		OL3	0.6	WLZ	-0.6
7	1.0 D + 0.6 W4	Yes	Y	DL	1	RLL		OL4	0.6	WLZ	-0.6
8	1.0 D + 0.45 W1 + 0.75 S	Yes	Y	DL	1	RLL	0.75	OL1	0.45	WLZ	0.45
9	1.0 D + 0.45 W2 + 0.75 S	Yes	Y	DL	1	RLL	0.75	OL2	0.45	WLZ	0.45
10	1.0 D + 0.45 W3 + 0.75 S	Yes	Y	DL	1	RLL	0.75	OL3	0.45	WLZ	-0.45
11	1.0 D + 0.45 W4 + 0.75 S	Yes	Y	DL	1	RLL	0.75	OL4	0.45	WLZ	-0.45
12	0.6 D + 0.6 W1	Yes	Y	DL	0.6	RLL		OL1	0.6	WLZ	0.6
13	0.6 D + 0.6 W2	Yes	Y	DL	0.6	RLL		OL2	0.6	WLZ	0.6
14	0.6 D + 0.6 W3	Yes	Y	DL	0.6	RLL		OL3	0.6	WLZ	-0.6
15	0.6 D + 0.6 W4	Yes	Y	DL	0.6	RLL		OL4	0.6	WLZ	-0.6
16			Y								
17	LRFD Loads		Y								
18	1.4 D		Y	DL	1.4	RLL					
19	1.2 D + 1.6 S + 0.5 W1		Y	DL	1.2	RLL	1.6	OL1	0.5		
20	1.2 D + 1.6 S + 0.5 W2		Y	DL	1.2	RLL	1.6	OL2	0.5		
21	1.2 D + 1.6 S + 0.5 W3		Y	DL	1.2	RLL	1.6	OL3	0.5		
22	1.2 D + 1.6 S + 0.5 W4		Y	DL	1.2	RLL	1.6	OL4	0.5		
23	1.2 D + 1.0 W1		Y	DL	1.2	RLL		OL1	1		
24	1.2 D + 1.0 W2		Y	DL	1.2	RLL		OL2	1		
25	1.2 D + 1.0 W3		Y	DL	1.2	RLL		OL3	1		
26	1.2 D + 1.0 W4		Y	DL	1.2	RLL		OL4	1		
27	0.9 D + 1.0 W1		Y	DL	0.9	RLL		OL1	1		
28	0.9 D + 1.0 W2		Y	DL	0.9	RLL		OL2	1		
29	0.9 D + 1.0 W3		Y	DL	0.9	RLL		OL3	1		
30	0.9 D + 1.0 W4		Y	DL	0.9	RLL		OL4	1		

Envelope Node Reactions

	Node Label		X [lb]	LC	Y [lb]	LC	Z [lb]	LC	MX [lb-ft]	LC	MY [lb-ft]	LC	MZ [lb-ft]	LC
1	N2	max	16.291	12	1989.784	11	30.556	4	0	15	0	15	0	15
2		min	-67.406	11	-329.26	12	-43.225	6	0	2	0	2	0	2
3	N1	max	42.633	10	2381.096	10	520.191	6	0	15	0	15	0	15
4		min	-18.876	13	-1011.676	13	-409.145	4	0	2	0	2	0	2
5	N109	max	1.024	13	1951.028	10	448.987	6	0	15	0	15	0	15
6		min	-2.364	10	-842.335	13	-352.648	4	0	2	0	2	0	2
7	N110A	max	1.154	12	1715.302	11	27.663	4	0	15	0	15	0	15
8		min	-5.619	11	-282.555	12	-39.049	6	0	2	0	2	0	2
9	N237	max	2.728	10	1961.327	10	453.356	6	0	15	0	15	0	15
10		min	-1.03	13	-848.371	13	-355.863	4	0	2	0	2	0	2
11	N239	max	6.674	11	1713.904	11	27.713	4	0	15	0	15	0	15
12		min	-1.843	12	-279.994	12	-39.111	6	0	2	0	2	0	2
13	N244	max	0.021	14	1923.031	10	437.159	6	0	15	0	15	0	15
14		min	-0.038	9	-825.877	13	-345.015	4	0	2	0	2	0	2
15	N246	max	0.009	9	1686.276	11	27.295	4	0	15	0	15	0	15

Envelope Node Reactions (Continued)

Node Label		X [lb]	LC	Y [lb]	LC	Z [lb]	LC	MX [lb-ft]	LC	MY [lb-ft]	LC	MZ [lb-ft]	LC	
16		min	-0.002	14	-278.8	12	-38.455	6	0	2	0	2	0	2
17	N250	max	5.625	11	1715.239	11	27.662	4	0	15	0	15	0	15
18		min	-1.149	12	-282.562	12	-39.048	6	0	2	0	2	0	2
19	N253	max	0.956	13	1961.441	10	453.341	6	0	15	0	15	0	15
20		min	-2.715	10	-848.416	13	-355.853	4	0	2	0	2	0	2
21	N255	max	1.848	12	1713.889	11	27.713	4	0	15	0	15	0	15
22		min	-6.664	11	-279.994	12	-39.11	6	0	2	0	2	0	2
23	N257	max	2.352	10	1950.623	10	448.975	6	0	15	0	15	0	15
24		min	-1.087	13	-842.146	13	-352.623	4	0	2	0	2	0	2
25	N264	max	67.445	11	1989.591	11	30.564	4	0	15	0	15	0	15
26		min	-16.311	12	-329.213	12	-43.23	6	0	2	0	2	0	2
27	N268	max	6.437	12	1571.246	11	27.725	4	0	15	0	15	0	15
28		min	-27.707	11	-259.667	12	-39.131	6	0	2	0	2	0	2
29	N275	max	5.886	13	1672.964	10	417.354	6	0	15	0	15	0	15
30		min	-15.794	10	-729.453	13	-326.351	4	0	2	0	2	0	2
31	N281	max	19.029	13	2383.007	10	520.235	6	0	15	0	15	0	15
32		min	-42.318	10	-1012.665	13	-409.23	4	0	2	0	2	0	2
33	N71	max	15.516	11	1717.771	11	27.476	4	0	15	0	15	0	15
34		min	-3.569	12	-282.516	12	-38.766	6	0	2	0	2	0	2
35	N73	max	7.807	10	1982.441	10	445.934	6	0	15	0	15	0	15
36		min	-3.138	13	-852.34	13	-352.157	4	0	2	0	2	0	2
37	N161	max	3.024	13	1980.429	10	445.93	6	0	15	0	15	0	15
38		min	-7.703	10	-851.399	13	-352.074	4	0	2	0	2	0	2
39	N163	max	3.573	12	1717.56	11	27.476	4	0	15	0	15	0	15
40		min	-15.49	11	-282.551	12	-38.768	6	0	2	0	2	0	2
41	N179	max	15.366	10	1676.371	10	417.429	6	0	15	0	15	0	15
42		min	-5.765	13	-731.15	13	-326.526	4	0	2	0	2	0	2
43	N181	max	27.622	11	1571.642	11	27.736	4	0	15	0	15	0	15
44		min	-6.429	12	-259.528	12	-39.134	6	0	2	0	2	0	2
45	Totals:	max	0.001	10	39034.626	10	4571.867	14						
46		min	0	12	-8087.966	12	-3627.905	4						

Envelope AISC 15TH (360-16): ASD Member Steel Code Checks

Member	Shape	Code Check	Loc[in]	LC	Shear Check	Loc[in]	LC	DirLcPnc/om [lb]	Pnt/om [lb]	Mnyy/om [lb-ft]	Mnzz/om [lb-ft]	Cb	Eqn	
1	M72	PIPE2.5A21168	0.704	38.502	11	0.15	169.409	11	20336.2	28358.413	2081.747	2081.747	1	H1-1b
2	M71	PIPE2.5A21168	0.686	700.738	10	0.156	569.831	10	20336.2	28358.413	2081.747	2081.747	1	H1-1b
3	M133	1.5X1.5X0.083	0.409	62.926	6	0.013	123.283	y 11	1562.282	14085.15	624.421	624.421	1.136	H1-1a
4	M15	1.5X1.5X0.083	0.409	62.926	6	0.012	123.283	y 11	1562.276	14085.15	624.421	624.421	1.136	H1-1a
5	M112	1.5X1.5X0.083	0.359	62.926	6	0.004	123.283	y 10	1562.282	14085.15	624.421	624.421	1.136	H1-1a
6	M121	1.5X1.5X0.083	0.359	62.926	6	0.004	123.283	y 10	1562.282	14085.15	624.421	624.421	1.136	H1-1a
7	M52	1.5X1.5X0.083	0.356	62.926	6	0.004	123.283	y 3	1562.282	14085.15	624.421	624.421	1.136	H1-1a
8	M118	1.5X1.5X0.083	0.356	62.926	6	0.004	123.283	y 3	1562.282	14085.15	624.421	624.421	1.136	H1-1a
9	M132	PIPE2.0A21165	0.355	6.56	10	0.078	0	6	11486.971	23232.186	1397.505	1397.505	1	H1-1a
10	M6	PIPE2.0A21165	0.355	6.56	10	0.078	0	6	11486.971	23232.186	1397.505	1397.505	1	H1-1a
11	M82	1.5X1.5X0.083	0.354	62.926	6	0.006	123.283	y 3	1562.282	14085.15	624.421	624.421	1.136	H1-1a
12	M32	1.5X1.5X0.083	0.354	62.926	6	0.006	123.283	y 10	1562.282	14085.15	624.421	624.421	1.136	H1-1a
13	M116	1.5X1.5X0.083	0.347	62.926	6	0.002	123.283	y 9	1562.282	14085.15	624.421	624.421	1.136	H1-1a
14	M91	1.5X1.5X0.083	0.332	62.926	6	0.01	123.283	y 10	1562.282	14085.15	624.421	624.421	1.136	H1-1a
15	M124	1.5X1.5X0.083	0.332	62.926	6	0.011	123.283	y 10	1562.282	14085.15	624.421	624.421	1.136	H1-1a
16	M134	PIPE2.0A21165	0.25	42.81	11	0.075	42.81	6	18131.498	23232.186	1397.505	1397.505	1	H1-1b
17	M5	PIPE2.0A21165	0.25	42.81	11	0.075	42.81	6	18131.498	23232.186	1397.505	1397.505	1	H1-1b
18	M114	PIPE2.0A21165	0.237	7.38	6	0.067	0	6	11486.971	23232.186	1397.505	1397.505	1	H1-1b
19	M120	PIPE2.0A21165	0.237	7.38	6	0.067	0	6	11486.971	23232.186	1397.505	1397.505	1	H1-1b
20	M51	PIPE2.0A21165	0.235	7.38	6	0.067	0	6	11486.971	23232.186	1397.505	1397.505	1	H1-1b
21	M123	PIPE2.0A21165	0.235	7.38	6	0.067	0	6	11486.971	23232.186	1397.505	1397.505	1	H1-1b

Envelope AISC 15TH (360-16): ASD Member Steel Code Checks (Continued)

Member	Shape	Code Check	Loc[in]	LcShear	Check	Loc[in]	DirLcPnc/om	[lb]	Pnt/om	[lb]	Mnyy/om	[lb-ft]	Mnzz/om	[lb-ft]	Cb	Eqn
22	M34	PIPE2.0A21165	0.234	7.38	6	0.066	0	6	11486.971	23232.186	1397.505	1397.505	1	H1-1b		
23	M81	PIPE2.0A21165	0.234	7.38	6	0.066	0	6	11486.971	23232.186	1397.505	1397.505	1	H1-1b		
24	M115	PIPE2.0A21165	0.229	7.38	6	0.065	0	6	11486.971	23232.186	1397.505	1397.505	1	H1-1b		
25	M89	PIPE2.0A21165	0.215	7.38	6	0.062	0	6	11486.971	23232.186	1397.505	1397.505	1	H1-1b		
26	M129	PIPE2.0A21165	0.215	7.38	6	0.062	0	6	11486.971	23232.186	1397.505	1397.505	1	H1-1b		
27	M125	PIPE2.0A21165	0.148	42.81	10	0.059	42.81	6	18131.498	23232.186	1397.505	1397.505	1	H1-1b		
28	M90	PIPE2.0A21165	0.147	42.81	10	0.059	42.81	6	18131.498	23232.186	1397.505	1397.505	1	H1-1b		
29	M33	PIPE2.0A21165	0.132	42.81	10	0.064	42.81	6	18131.498	23232.186	1397.505	1397.505	1	H1-1b		
30	M80	PIPE2.0A21165	0.132	42.81	10	0.064	42.81	6	18131.498	23232.186	1397.505	1397.505	1	H1-1b		
31	M113	PIPE2.0A21165	0.126	42.81	10	0.065	42.81	6	18131.498	23232.186	1397.505	1397.505	1	H1-1b		
32	M122	PIPE2.0A21165	0.126	42.81	10	0.065	42.81	6	18131.498	23232.186	1397.505	1397.505	1	H1-1b		
33	M50	PIPE2.0A21165	0.125	42.81	10	0.064	42.81	6	18131.498	23232.186	1397.505	1397.505	1	H1-1b		
34	M119	PIPE2.0A21165	0.125	42.81	10	0.064	42.81	6	18131.498	23232.186	1397.505	1397.505	1	H1-1b		
35	M117	PIPE2.0A21165	0.122	42.81	10	0.062	42.81	6	18131.498	23232.186	1397.505	1397.505	1	H1-1b		
36	M75B	1.5X1.5X0.083	0.042	65.188	10	0.029	65.188	y	6	5583.566	14085.15	624.421	624.421	1.136	H1-1b*	
37	M19	1.5X1.5X0.083	0.042	67.386	10	0.029	67.386	y	6	5229.103	14085.15	624.421	624.421	1.136	H1-1b*	

Envelope AA ADM1-15: ASD - BUILDING Member Aluminum Code Checks

Member	Shape	Code Check	Loc[in]	LcShear	Check	Loc[in]	DirLcPnc/Om	[lb]	Pnt/Om	[lb]	Mny/Om	[lb-ft]	Mnz/Om	[lb-ft]	Vny/Om	[lb]	Vnz/Om	[lb]	Cb	Eqn
1	M46	HR300_ALA	0.723	46.375	11	0.066	46.375	y	11	2501.578	14342.564	533.921	934.619	7307.692	3206.154	1.561	H.1-1			
2	M66	HR300_ALA	0.723	46.375	11	0.066	46.375	y	11	2501.578	14342.564	533.921	934.619	7307.692	3206.154	1.561	H.1-1			
3	M74	HR300_ALA	0.721	44.167	11	0.066	46.375	y	11	6230.805	14342.564	533.921	934.619	7307.692	3206.154	2.325	H.1-1			
4	M43	HR300_ALA	0.721	44.167	11	0.066	46.375	y	11	6230.805	14342.564	533.921	934.619	7307.692	3206.154	2.325	H.1-1			
5	M55	HR300_ALA	0.721	44.167	11	0.067	46.375	y	11	6230.805	14342.564	533.921	934.619	7307.692	3206.154	2.326	H.1-1			
6	M60	HR300_ALA	0.721	44.167	11	0.067	46.375	y	11	6230.805	14342.564	533.921	934.619	7307.692	3206.154	2.326	H.1-1			
7	M75	HR300_ALA	0.721	44.167	11	0.066	165.625	y	10	6230.805	14342.564	533.921	934.619	7307.692	3206.154	2.326	H.1-1			
8	M40	HR300_ALA	0.721	44.167	11	0.067	165.625	y	10	6230.805	14342.564	533.921	934.619	7307.692	3206.154	2.326	H.1-1			
9	M58	HR300_ALA	0.721	44.167	11	0.067	46.375	y	11	6230.805	14342.564	533.921	934.619	7307.692	3206.154	2.326	H.1-1			
10	M59	HR300_ALA	0.721	44.167	11	0.067	46.375	y	11	6230.805	14342.564	533.921	934.619	7307.692	3206.154	2.326	H.1-1			
11	M65	HR300_ALA	0.721	44.167	11	0.067	46.375	y	11	6230.805	14342.564	533.921	934.619	7307.692	3206.154	2.326	H.1-1			
12	M49	HR300_ALA	0.721	44.167	11	0.067	46.375	y	11	6230.805	14342.564	533.921	934.619	7307.692	3206.154	2.326	H.1-1			
13	M84	HR300_ALA	0.721	44.167	11	0.067	46.375	y	11	6230.805	14342.564	533.921	934.619	7307.692	3206.154	2.326	H.1-1			
14	M37	HR300_ALA	0.721	44.167	11	0.066	46.375	y	11	6230.805	14342.564	533.921	934.619	7307.692	3206.154	2.326	H.1-1			
15	M83	HR300_ALA	0.654	46.375	11	0.071	46.375	y	11	2501.578	14342.564	533.921	934.619	7307.692	3206.154	1.327	H.1-1			
16	M73	HR300_ALA	0.653	46.375	11	0.07	46.375	y	11	2501.578	14342.564	533.921	934.619	7307.692	3206.154	1.327	H.1-1			
17	M130	HR300_ALA	0.626	46.375	11	0.057	46.375	y	11	2501.578	14342.564	533.921	934.619	7307.692	3206.154	1.565	H.1-1			
18	M110	HR300_ALA	0.626	46.375	11	0.057	46.375	y	11	2501.578	14342.564	533.921	934.619	7307.692	3206.154	1.565	H.1-1			
19	M111	HR300_ALA	0.619	44.167	11	0.058	46.375	y	11	6230.805	14342.564	533.921	934.619	7307.692	3206.154	2.325	H.1-1			
20	M128	HR300_ALA	0.619	44.167	11	0.058	46.375	y	11	6230.805	14342.564	533.921	934.619	7307.692	3206.154	2.325	H.1-1			
21	M127	HR300_ALA	0.619	44.167	11	0.058	46.375	y	11	6230.805	14342.564	533.921	934.619	7307.692	3206.154	2.326	H.1-1			
22	M126	HR300_ALA	0.619	44.167	11	0.058	46.375	y	11	6230.805	14342.564	533.921	934.619	7307.692	3206.154	2.326	H.1-1			
23	M93	HR300_ALA	0.616	44.167	11	0.059	46.375	y	11	6230.805	14342.564	533.921	934.619	7307.692	3206.154	2.343	H.1-1			
24	M94	HR300_ALA	0.613	44.167	11	0.06	46.375	y	11	6230.805	14342.564	533.921	934.619	7307.692	3206.154	2.314	H.1-1			

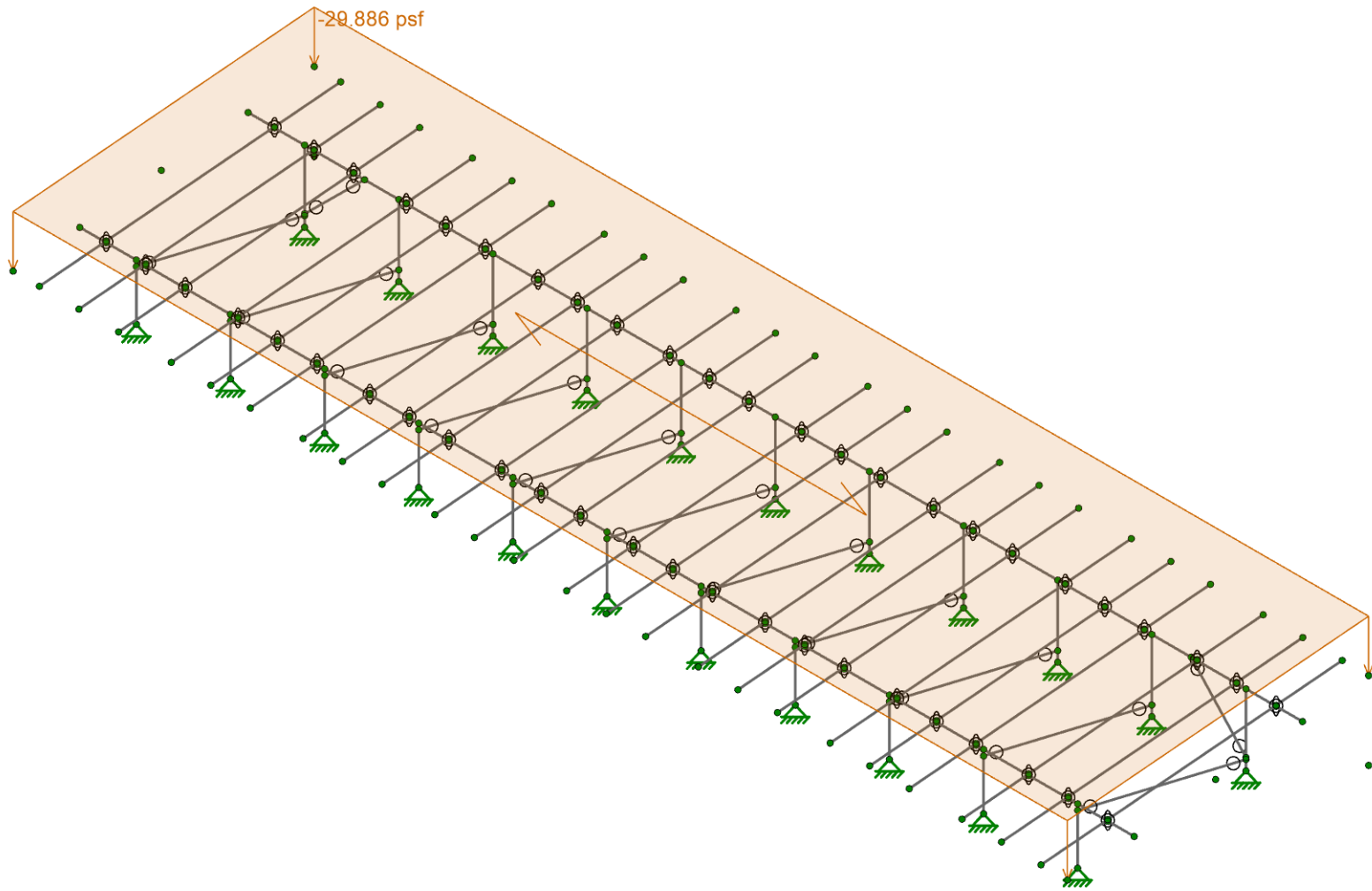
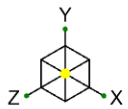

Loads: BLC 3, Roof Live/Snow

Vector Structural Engineering
LKN
U2716.0366.231

Sunturf Ground Mount B7 LF 5°

SK-1
Feb 02, 2023
Sunturf Ground Mount B7 LF 5deg 3R.r3d

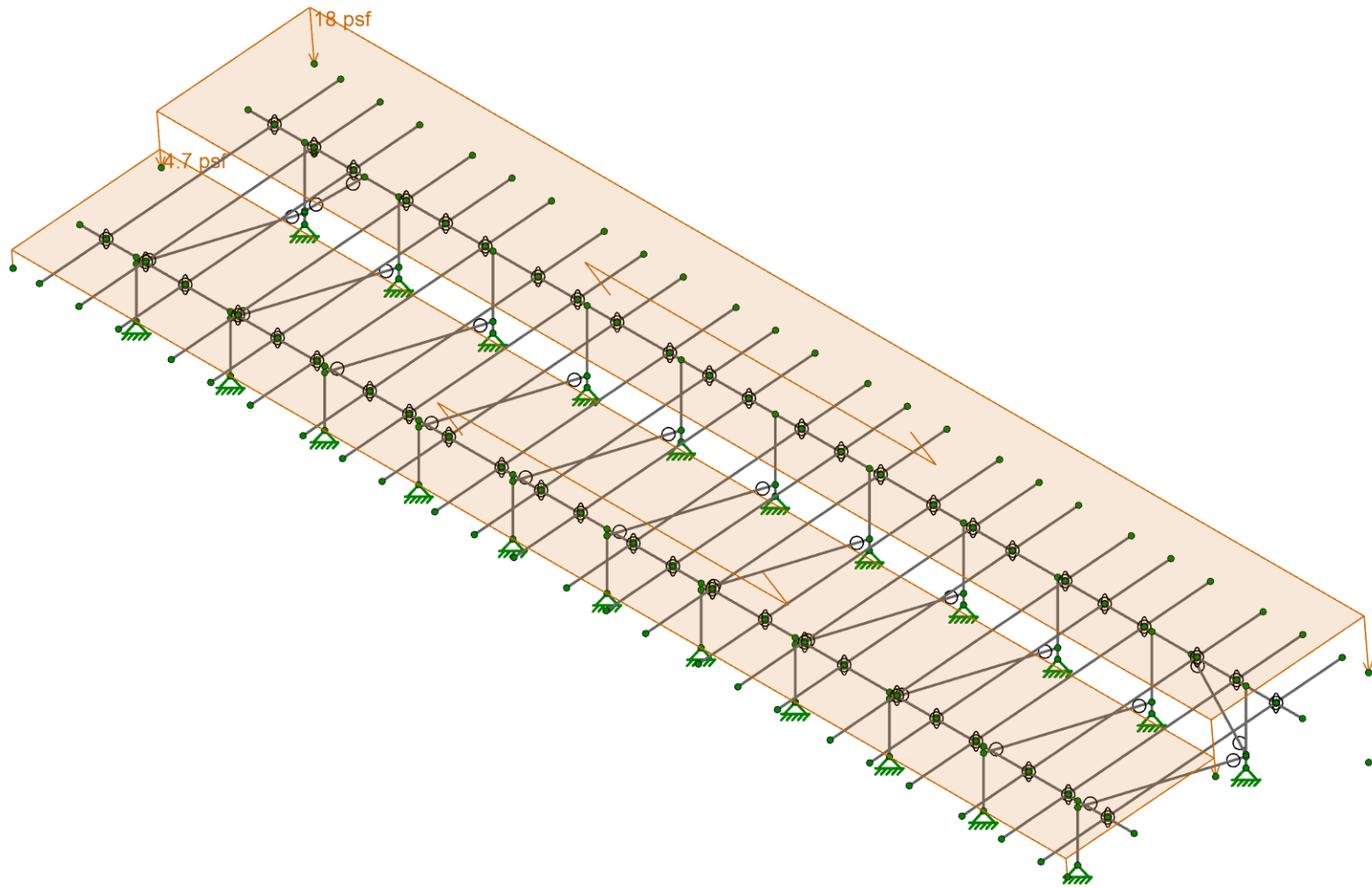
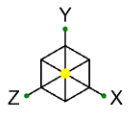

Loads: BLC 4, Wind A 0 deg

Vector Structural Engineering
LKN
U2716.0366.231

Sunturf Ground Mount B7 LF 5°

SK-2
Feb 02, 2023
Sunturf Ground Mount B7 LF 5deg 3R.r3d

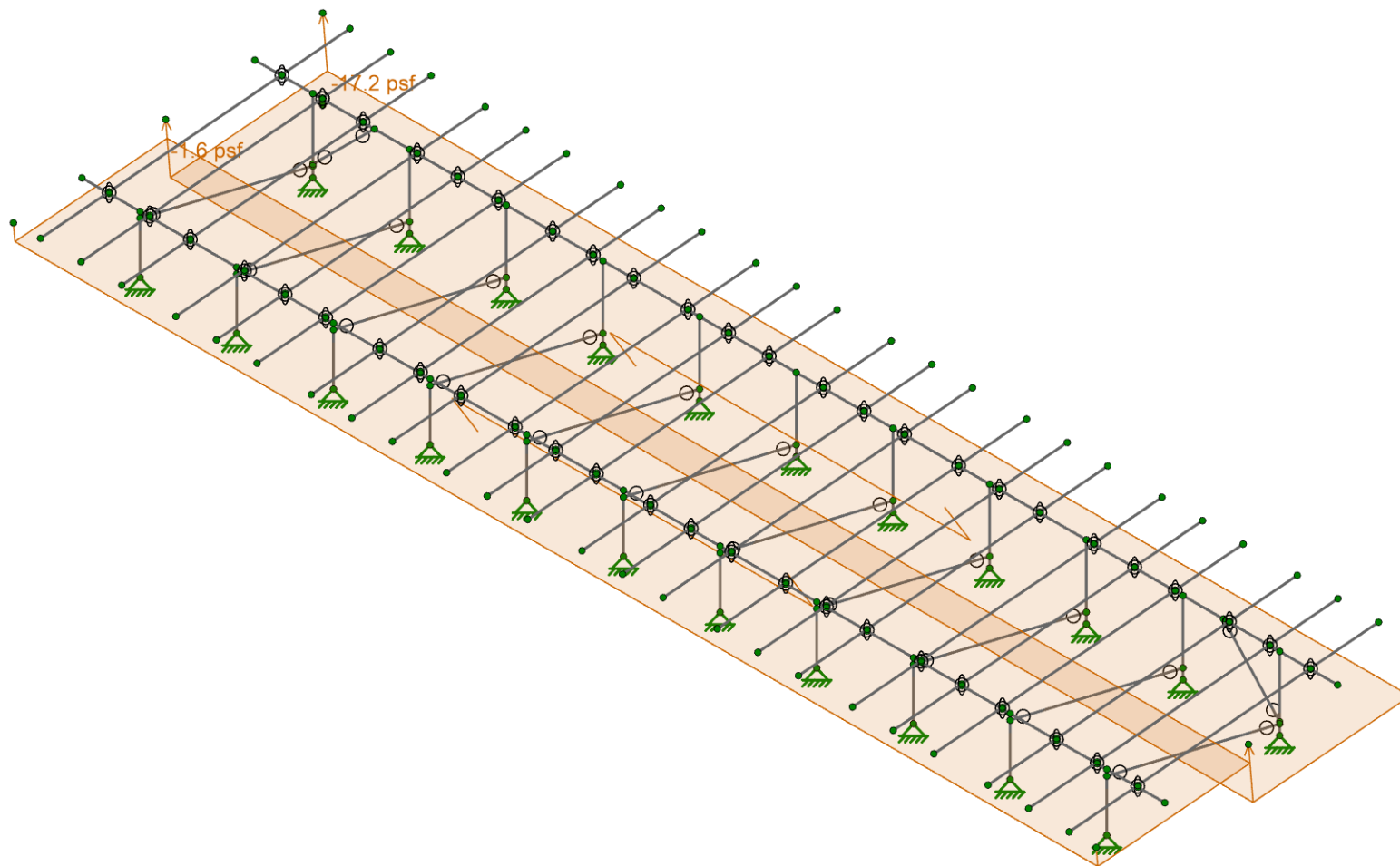
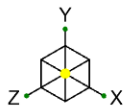

Loads: BLC 5, Wind B 0 deg

Vector Structural Engineering
LKN
U2716.0366.231

Sunturf Ground Mount B7 LF 5°

SK-3
Feb 02, 2023
Sunturf Ground Mount B7 LF 5deg 3R.r3d

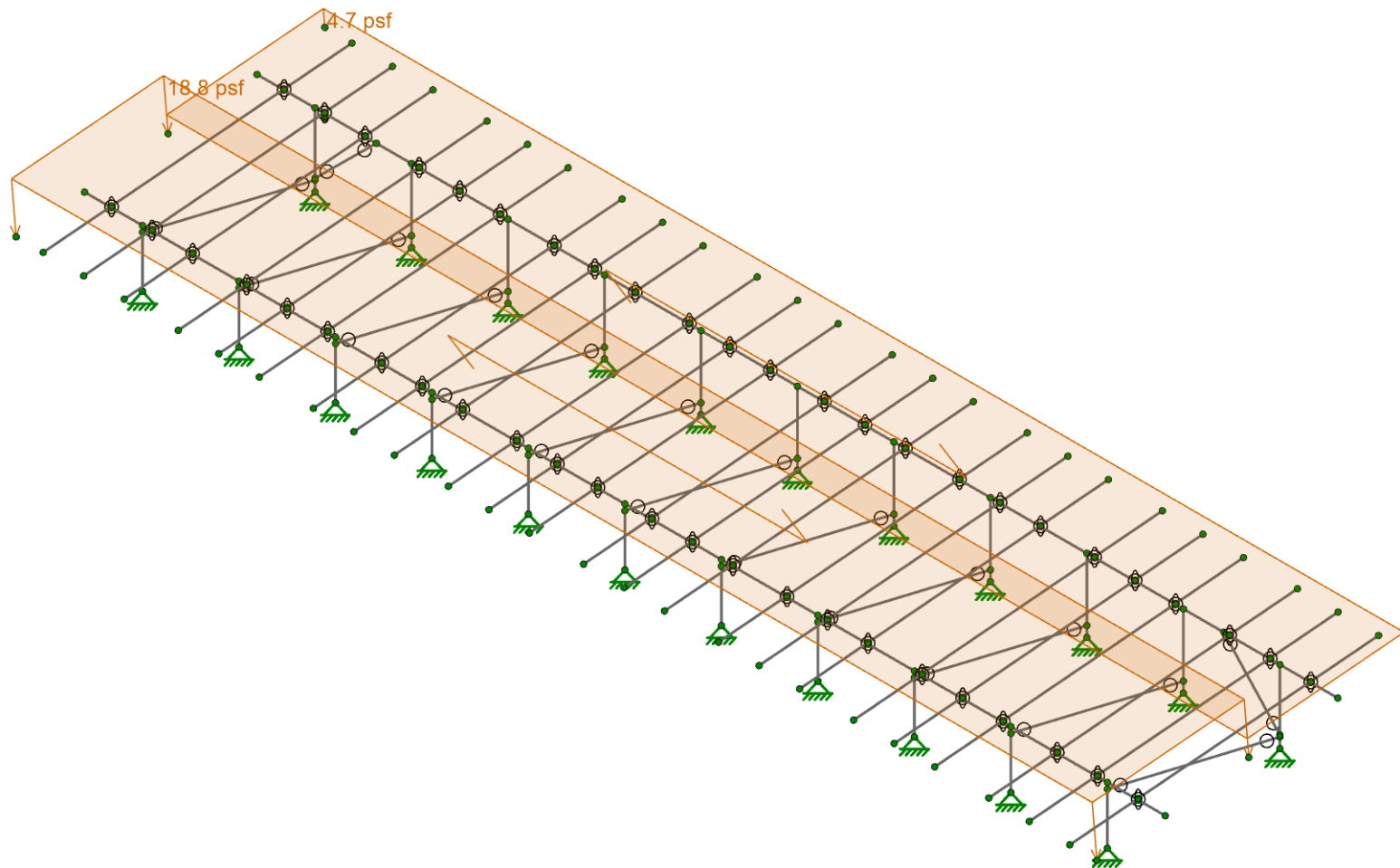
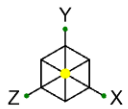

Loads: BLC 6, Wind A 180 deg

Vector Structural Engineering
LKN
U2716.0366.231

Sunturf Ground Mount B7 LF 5°

SK-4
Feb 02, 2023
Sunturf Ground Mount B7 LF 5deg 3R.r3d

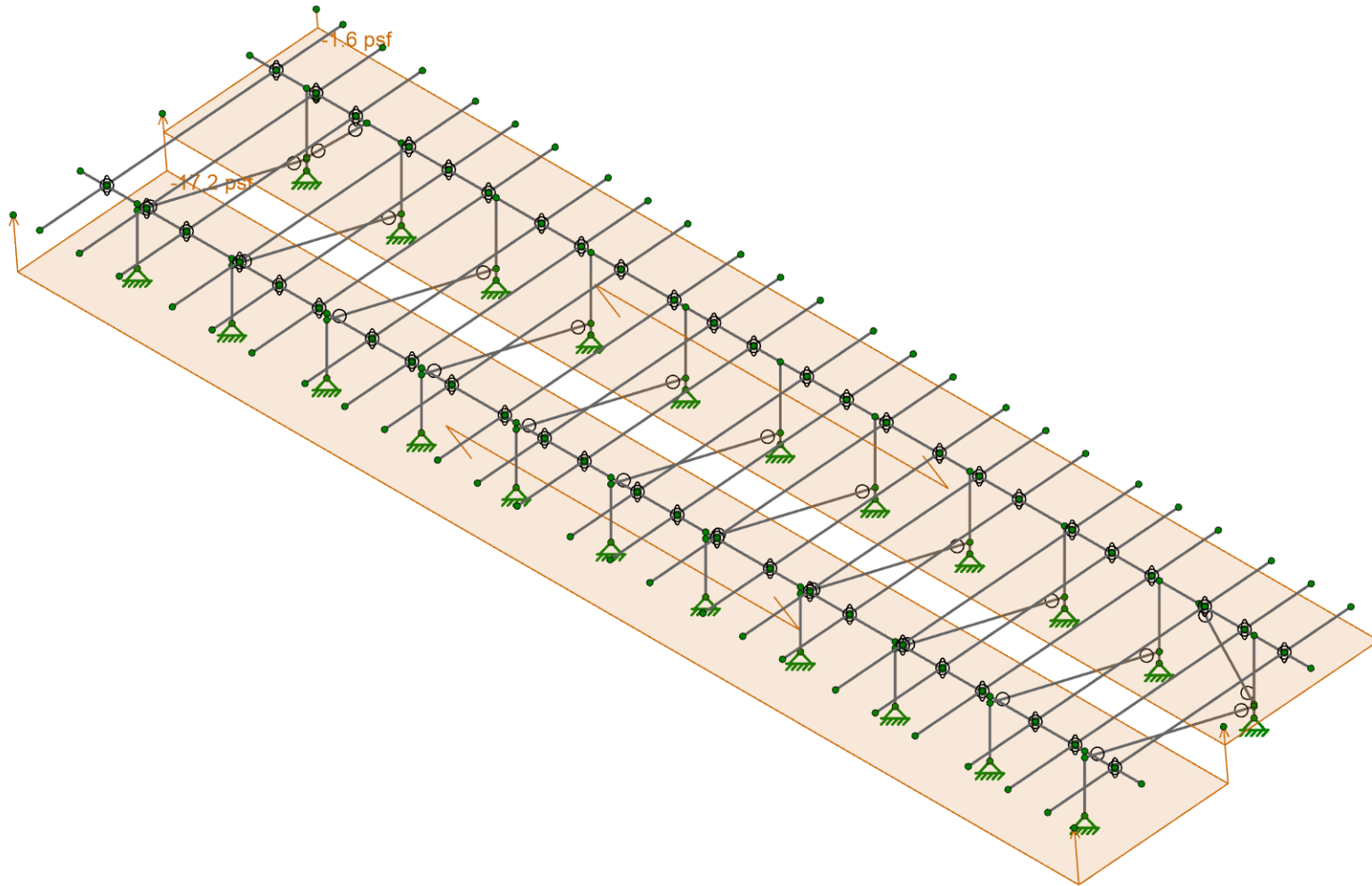
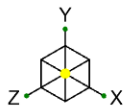

Loads: BLC 7, Wind B 180 deg

Vector Structural Engineering
LKN
U2716.0366.231

Sunturf Ground Mount B7 LF 5°

SK-5
Feb 02, 2023
Sunturf Ground Mount B7 LF 5deg 3R.r3d

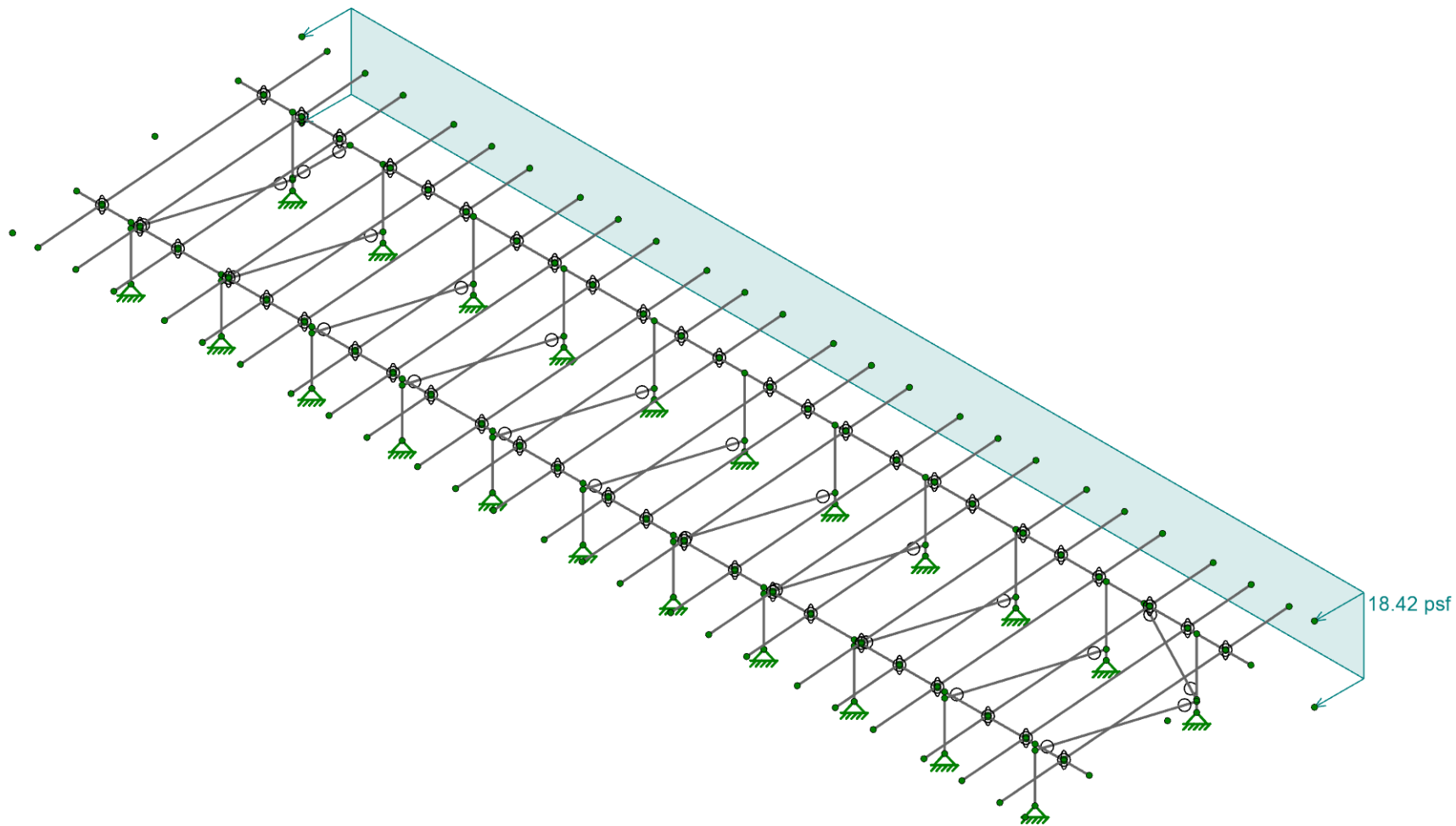
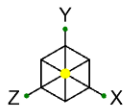

Loads: BLC 8, Wind Z

Vector Structural Engineering
LKN
U2716.0366.231

Sunturf Ground Mount B7 LF 5°

SK-6
Feb 02, 2023
Sunturf Ground Mount B7 LF 5deg 3R.r3d

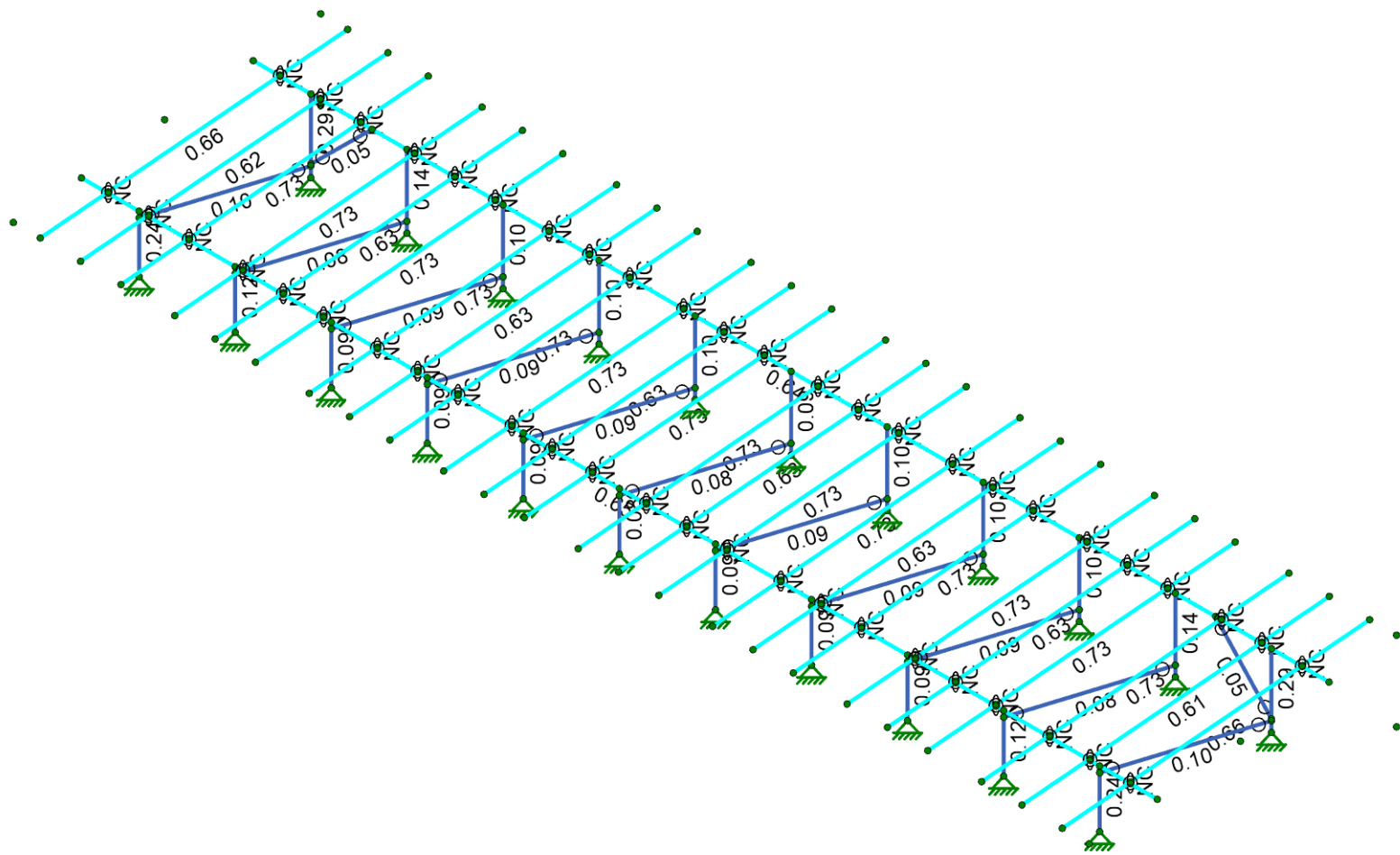
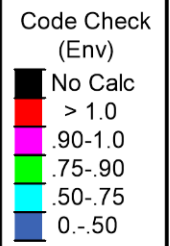
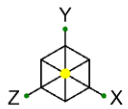

Member Code Checks Displayed (Enveloped)		
Vector Structural Engineering	Sunturf Ground Mount B7 LF 5°	SK-7
LKN		Feb 02, 2023
U2716.0366.231		Sunturf Ground Mount B7 LF 5deg 3R.r3d

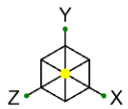

Shear Check (Env)

- No Calc
- > 1.0
- .90-1.0
- .75-90
- .50-75
- 0-.50

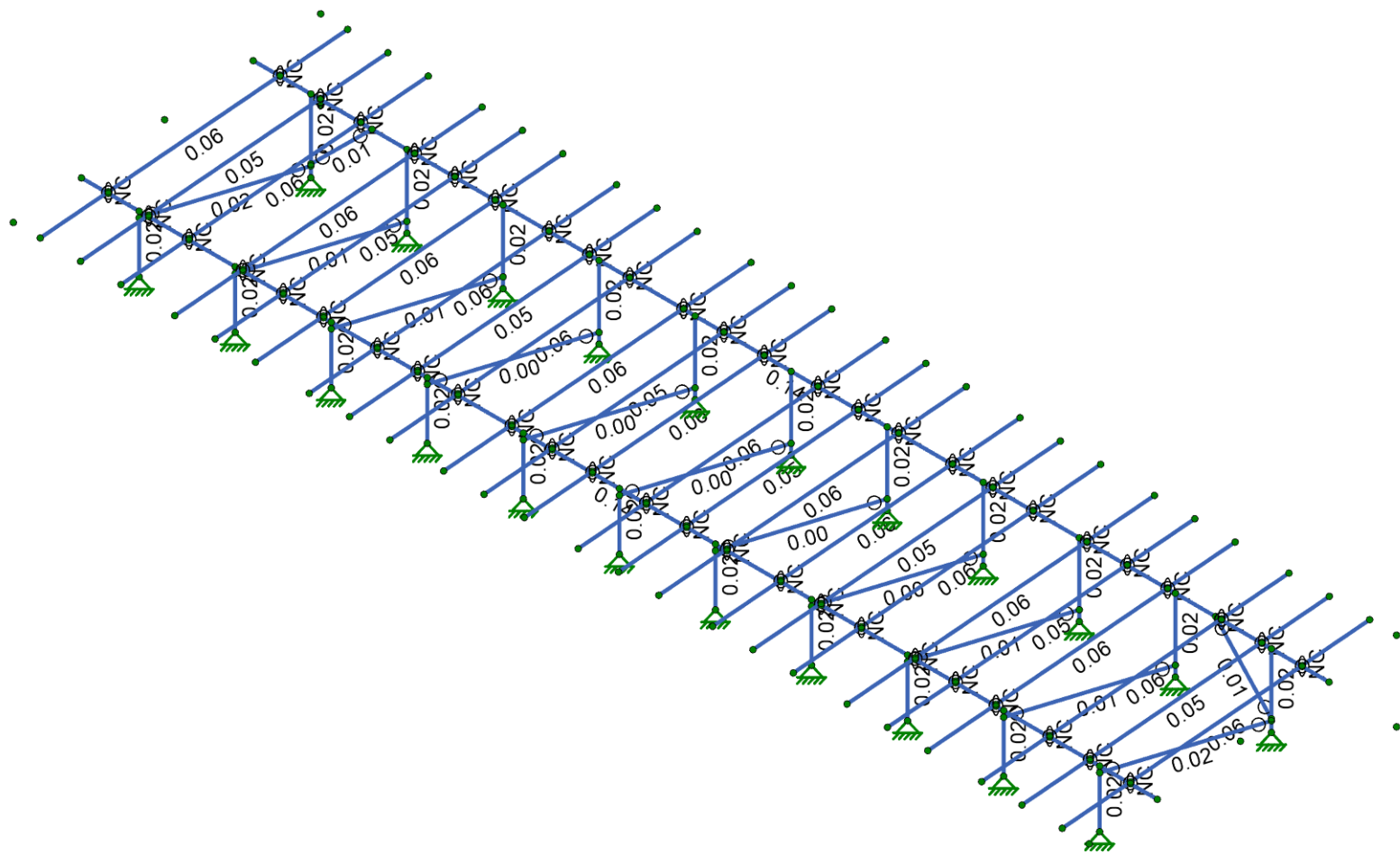

Member Shear Checks Displayed (Enveloped)		
Vector Structural Engineering	Sunturf Ground Mount B7 LF 5°	SK-8
LKN		Feb 02, 2023
U2716.0366.231		Sunturf Ground Mount B7 LF 5deg 3R.r3d

Basic Load Cases

	BLC Description	Category	Y Gravity	Distributed	Area(Member)
1	Self Weight	DL	-1.05		
2	Solar Panel Weight	DL			1
3	Roof Live/Snow	RLL			1
4	Wind A 0 deg	OL1			2
5	Wind B 0 deg	OL2			2
6	Wind A 180 deg	OL3			2
7	Wind B 180 deg	OL4			2
8	Wind Z	WLZ			1
9	BLC 2 Transient Area Loads	None		52	
10	BLC 3 Transient Area Loads	None		52	
11	BLC 4 Transient Area Loads	None		160	
12	BLC 5 Transient Area Loads	None		160	
13	BLC 6 Transient Area Loads	None		160	
14	BLC 7 Transient Area Loads	None		160	
15	BLC 8 Transient Area Loads	None		96	

Member Area Loads (BLC 2 : Solar Panel Weight)

	Node A	Node B	Node C	Node D	Direction	Load Direction	Magnitude [psf]
1	N197	N200	N199	N196	Y	A-B	-3

Member Area Loads (BLC 3 : Roof Live/Snow)

	Node A	Node B	Node C	Node D	Direction	Load Direction	Magnitude [psf]
1	N197	N200	N199	N196	PY	A-B	-30

Member Area Loads (BLC 4 : Wind A 0 deg)

	Node A	Node B	Node C	Node D	Direction	Load Direction	Magnitude [psf]
1	N197	N200	N201	N198	Perp	A-B	18
2	N198	N201	N199	N196	Perp	A-B	4.7

Member Area Loads (BLC 5 : Wind B 0 deg)

	Node A	Node B	Node C	Node D	Direction	Load Direction	Magnitude [psf]
1	N197	N200	N201	N198	Perp	A-B	-17.2
2	N198	N201	N199	N196	Perp	A-B	-1.6

Member Area Loads (BLC 6 : Wind A 180 deg)

	Node A	Node B	Node C	Node D	Direction	Load Direction	Magnitude [psf]
1	N197	N200	N201	N198	Perp	A-B	4.7
2	N198	N201	N199	N196	Perp	A-B	18.8

Member Area Loads (BLC 7 : Wind B 180 deg)

	Node A	Node B	Node C	Node D	Direction	Load Direction	Magnitude [psf]
1	N197	N200	N201	N198	Perp	A-B	-1.6
2	N198	N201	N199	N196	Perp	A-B	-17.2

Member Area Loads (BLC 8 : Wind Z)

	Node A	Node B	Node C	Node D	Direction	Load Direction	Magnitude [psf]
1	N200	N197	N269	N270	Z	Open Structure	18.42

Load Combinations

	Description	Solve	P-Delta	BLC	Factor	BLC	Factor	BLC	Factor	BLC	Factor
1	ASD Loads		Y								
2	1.0 D	Yes	Y	DL	1						
3	1.0 D + 1.0 S	Yes	Y	DL	1	RLL	1				
4	1.0 D + 0.6 W1	Yes	Y	DL	1	RLL		OL1	0.6	WLZ	0.6
5	1.0 D + 0.6 W2	Yes	Y	DL	1	RLL		OL2	0.6	WLZ	0.6
6	1.0 D + 0.6 W3	Yes	Y	DL	1	RLL		OL3	0.6	WLZ	-0.6
7	1.0 D + 0.6 W4	Yes	Y	DL	1	RLL		OL4	0.6	WLZ	-0.6
8	1.0 D + 0.45 W1 + 0.75 S	Yes	Y	DL	1	RLL	0.75	OL1	0.45	WLZ	0.45
9	1.0 D + 0.45 W2 + 0.75 S	Yes	Y	DL	1	RLL	0.75	OL2	0.45	WLZ	0.45
10	1.0 D + 0.45 W3 + 0.75 S	Yes	Y	DL	1	RLL	0.75	OL3	0.45	WLZ	-0.45
11	1.0 D + 0.45 W4 + 0.75 S	Yes	Y	DL	1	RLL	0.75	OL4	0.45	WLZ	-0.45
12	0.6 D + 0.6 W1	Yes	Y	DL	0.6	RLL		OL1	0.6	WLZ	0.6
13	0.6 D + 0.6 W2	Yes	Y	DL	0.6	RLL		OL2	0.6	WLZ	0.6
14	0.6 D + 0.6 W3	Yes	Y	DL	0.6	RLL		OL3	0.6	WLZ	-0.6
15	0.6 D + 0.6 W4	Yes	Y	DL	0.6	RLL		OL4	0.6	WLZ	-0.6
16			Y								
17	LRFD Loads		Y								
18	1.4 D		Y	DL	1.4	RLL					
19	1.2 D + 1.6 S + 0.5 W1		Y	DL	1.2	RLL	1.6	OL1	0.5		
20	1.2 D + 1.6 S + 0.5 W2		Y	DL	1.2	RLL	1.6	OL2	0.5		
21	1.2 D + 1.6 S + 0.5 W3		Y	DL	1.2	RLL	1.6	OL3	0.5		
22	1.2 D + 1.6 S + 0.5 W4		Y	DL	1.2	RLL	1.6	OL4	0.5		
23	1.2 D + 1.0 W1		Y	DL	1.2	RLL		OL1	1		
24	1.2 D + 1.0 W2		Y	DL	1.2	RLL		OL2	1		
25	1.2 D + 1.0 W3		Y	DL	1.2	RLL		OL3	1		
26	1.2 D + 1.0 W4		Y	DL	1.2	RLL		OL4	1		
27	0.9 D + 1.0 W1		Y	DL	0.9	RLL		OL1	1		
28	0.9 D + 1.0 W2		Y	DL	0.9	RLL		OL2	1		
29	0.9 D + 1.0 W3		Y	DL	0.9	RLL		OL3	1		
30	0.9 D + 1.0 W4		Y	DL	0.9	RLL		OL4	1		

Envelope Node Reactions

	Node Label		X [lb]	LC	Y [lb]	LC	Z [lb]	LC	MX [lb-ft]	LC	MY [lb-ft]	LC	MZ [lb-ft]	LC
1	N2	max	14.933	15	1930.365	3	9.859	5	0	15	0	15	0	15
2		min	-81.835	3	-409.93	15	-11.992	6	0	2	0	2	0	2
3	N1	max	99.365	8	2088.603	8	138.277	6	0	15	0	15	0	15
4		min	-27.376	13	-484.357	13	-123.455	5	0	2	0	2	0	2
5	N109	max	1.208	13	1676.762	8	119.216	6	0	15	0	15	0	15
6		min	-5.145	8	-394.811	13	-106.801	5	0	2	0	2	0	2
7	N110A	max	1.745	15	1668.814	3	8.671	5	0	15	0	15	0	15
8		min	-7.557	10	-355.471	15	-10.502	6	0	2	0	2	0	2
9	N237	max	5.392	8	1681.204	8	120.61	6	0	15	0	15	0	15
10		min	-1.194	13	-396.16	13	-108.566	5	0	2	0	2	0	2
11	N239	max	8.477	10	1666.551	3	8.718	5	0	15	0	15	0	15
12		min	-1.905	15	-354.468	15	-10.558	6	0	2	0	2	0	2
13	N244	max	0.044	13	1650.031	8	117.071	6	0	15	0	15	0	15
14		min	-0.256	3	-386.952	13	-103.264	5	0	2	0	2	0	2
15	N246	max	0.002	13	1635.64	3	8.309	5	0	15	0	15	0	15

Envelope Node Reactions (Continued)

Node Label		X [lb]	LC	Y [lb]	LC	Z [lb]	LC	MX [lb-ft]	LC	MY [lb-ft]	LC	MZ [lb-ft]	LC
16		min	8	-0.004	8	-347.226	15	-10.303	6	0	2	0	2
17	N250	max	10	7.551	10	1668.77	3	8.671	5	0	15	0	15
18		min	15	-1.745	15	-355.472	15	-10.502	6	0	2	0	2
19	N253	max	13	1.278	13	1681.268	8	120.605	6	0	15	0	15
20		min	8	-5.864	8	-396.173	13	-108.559	5	0	2	0	2
21	N255	max	15	1.905	15	1666.546	3	8.718	5	0	15	0	15
22		min	10	-8.48	10	-354.466	15	-10.558	6	0	2	0	2
23	N257	max	8	4.618	8	1676.378	8	119.221	6	0	15	0	15
24		min	13	-1.11	13	-394.711	13	-106.796	5	0	2	0	2
25	N264	max	3	81.905	3	1930.06	3	9.871	5	0	15	0	15
26		min	15	-14.931	15	-409.946	15	-11.99	6	0	2	0	2
27	N268	max	15	6.854	15	1532.624	10	8.493	5	0	15	0	15
28		min	10	-33.646	10	-328.778	15	-10.33	6	0	2	0	2
29	N275	max	13	7.635	13	1387.584	8	110.084	6	0	15	0	15
30		min	8	-35.073	8	-326.665	13	-98.401	5	0	2	0	2
31	N281	max	13	26.764	13	2089.039	8	138.261	6	0	15	0	15
32		min	8	-96.263	8	-484.452	13	-123.513	5	0	2	0	2
33	N71	max	10	19.262	10	1663.807	3	8.53	5	0	15	0	15
34		min	15	-4.206	15	-352.396	15	-10.431	6	0	2	0	2
35	N73	max	8	15.911	8	1702.887	8	119.86	6	0	15	0	15
36		min	13	-3.6	13	-399.767	13	-106.854	5	0	2	0	2
37	N161	max	13	3.633	13	1700.884	8	119.883	6	0	15	0	15
38		min	8	-16.174	8	-399.234	13	-106.796	5	0	2	0	2
39	N163	max	15	4.206	15	1663.581	3	8.53	5	0	15	0	15
40		min	10	-19.255	10	-352.406	15	-10.431	6	0	2	0	2
41	N179	max	3	33.498	3	1388.944	8	110.043	6	0	15	0	15
42		min	13	-7.28	13	-326.951	13	-98.506	5	0	2	0	2
43	N181	max	10	33.588	10	1533.073	10	8.504	5	0	15	0	15
44		min	15	-6.857	15	-328.748	15	-10.324	6	0	2	0	2
45	Totals:	max	8	0.001	8	37029.737	3	1215.209	6				
46		min	13	0	13	-3491.28	13	-1094.638	13				

Envelope AISC 15TH (360-16): ASD Member Steel Code Checks

Member	Shape	Code Check	Loc[in]	LC	Shear Check	Loc[in]	Dir	LC	Pnc/om [lb]	Pnt/om [lb]	Mny/om [lb-ft]	Mnz/om [lb-ft]	Cb	Eqn	
1	M72	PIPE2.5A21168	0.649	700.738	10	0.139	169.409	10	20336.2	28358.413	2081.747	2081.747	1	H1-1b	
2	M71	PIPE2.5A21168	0.638	700.738	3	0.14	569.831	8	20336.2	28358.413	2081.747	2081.747	1	H1-1b	
3	M132	PIPE2.0A21165	0.293	49.809	3	0.02	0	6	17524.058	23232.186	1397.505	1397.505	1	H1-1b	
4	M6	PIPE2.0A21165	0.287	49.809	3	0.02	0	6	17524.058	23232.186	1397.505	1397.505	1	H1-1b	
5	M134	PIPE2.0A21165	0.244	39.089	3	0.021	35.424	6	19528.623	23232.186	1397.505	1397.505	1	H1-1b	
6	M5	PIPE2.0A21165	0.244	39.089	3	0.021	35.424	6	19528.623	23232.186	1397.505	1397.505	1	H1-1b	
7	M129	PIPE2.0A21165	0.141	49.809	8	0.016	0	6	17524.058	23232.186	1397.505	1397.505	1	H1-1b	
8	M89	PIPE2.0A21165	0.136	49.809	8	0.016	0	6	17524.058	23232.186	1397.505	1397.505	1	H1-1b	
9	M125	PIPE2.0A21165	0.12	39.089	10	0.016	35.424	6	19528.623	23232.186	1397.505	1397.505	1	H1-1b	
10	M90	PIPE2.0A21165	0.12	39.089	10	0.016	35.424	6	19528.623	23232.186	1397.505	1397.505	1	H1-1b	
11	M133	1.5X1.5X0.083	0.1	121.297	6	0.016	121.297	y	3	1613.849	14085.15	624.421	624.421	1.136	H1-1b*
12	M15	1.5X1.5X0.083	0.1	121.297	6	0.016	121.297	y	3	1613.844	14085.15	624.421	624.421	1.136	H1-1b*
13	M34	PIPE2.0A21165	0.097	0	8	0.017	0	6	17524.058	23232.186	1397.505	1397.505	1	H1-1b*	
14	M81	PIPE2.0A21165	0.097	0	8	0.017	0	6	17524.058	23232.186	1397.505	1397.505	1	H1-1b*	
15	M120	PIPE2.0A21165	0.096	0	8	0.017	0	6	17524.058	23232.186	1397.505	1397.505	1	H1-1b*	
16	M114	PIPE2.0A21165	0.096	0	8	0.017	0	6	17524.058	23232.186	1397.505	1397.505	1	H1-1b*	
17	M51	PIPE2.0A21165	0.096	0	8	0.017	0	6	17524.058	23232.186	1397.505	1397.505	1	H1-1b*	
18	M123	PIPE2.0A21165	0.096	0	8	0.017	0	6	17524.058	23232.186	1397.505	1397.505	1	H1-1b*	
19	M115	PIPE2.0A21165	0.094	0	8	0.017	0	6	17524.058	23232.186	1397.505	1397.505	1	H1-1b*	
20	M80	PIPE2.0A21165	0.089	35.424	10	0.017	35.424	6	19528.623	23232.186	1397.505	1397.505	1	H1-1b	
21	M33	PIPE2.0A21165	0.089	35.424	10	0.017	35.424	6	19528.623	23232.186	1397.505	1397.505	1	H1-1b	

Envelope AISC 15TH (360-16): ASD Member Steel Code Checks (Continued)

Member	Shape	Code Check	Loc[in]	LC Shear Check	Loc[in]	Dir	LC Pnc/om [lb]	Pnt/om [lb]	Mnyy/om [lb-ft]	Mnzz/om [lb-ft]	Cb	Eqn		
22	M112	1.5X1.5X0.083	0.087	121.297	6	0.004	121.297	y 3	1613.849	14085.15	624.421	624.421	1.136	H1-1b*
23	M121	1.5X1.5X0.083	0.087	121.297	6	0.004	121.297	y 3	1613.849	14085.15	624.421	624.421	1.136	H1-1b*
24	M82	1.5X1.5X0.083	0.087	121.297	6	0.006	121.297	y 3	1613.849	14085.15	624.421	624.421	1.136	H1-1b*
25	M32	1.5X1.5X0.083	0.087	121.297	6	0.006	121.297	y 3	1613.849	14085.15	624.421	624.421	1.136	H1-1b*
26	M118	1.5X1.5X0.083	0.086	121.297	6	0.004	121.297	y 3	1613.849	14085.15	624.421	624.421	1.136	H1-1b*
27	M52	1.5X1.5X0.083	0.086	121.297	6	0.004	121.297	y 3	1613.849	14085.15	624.421	624.421	1.136	H1-1b*
28	M50	PIPE2.0A21165	0.086	35.424	10	0.017	35.424	6	19528.623	23232.186	1397.505	1397.505	1	H1-1b*
29	M119	PIPE2.0A21165	0.086	35.424	10	0.017	35.424	6	19528.623	23232.186	1397.505	1397.505	1	H1-1b*
30	M113	PIPE2.0A21165	0.086	35.424	10	0.017	35.424	6	19528.623	23232.186	1397.505	1397.505	1	H1-1b*
31	M122	PIPE2.0A21165	0.086	35.424	10	0.017	35.424	6	19528.623	23232.186	1397.505	1397.505	1	H1-1b*
32	M116	1.5X1.5X0.083	0.084	121.297	6	0.002	121.297	y 3	1613.849	14085.15	624.421	624.421	1.136	H1-1b*
33	M117	PIPE2.0A21165	0.084	35.424	10	0.016	35.424	6	19528.623	23232.186	1397.505	1397.505	1	H1-1b*
34	M124	1.5X1.5X0.083	0.079	121.297	6	0.01	121.297	y 3	1613.849	14085.15	624.421	624.421	1.136	H1-1b*
35	M91	1.5X1.5X0.083	0.079	121.297	6	0.009	121.297	y 3	1613.849	14085.15	624.421	624.421	1.136	H1-1b*
36	M19	1.5X1.5X0.083	0.046	59.182	8	0.01	59.182	y 6	6569.691	14085.15	624.421	624.421	1.136	H1-1b*
37	M75B	1.5X1.5X0.083	0.045	56.667	8	0.01	56.667	y 6	7000.014	14085.15	624.421	624.421	1.136	H1-1b*

Envelope AA ADM1-15: ASD - BUILDING Member Aluminum Code Checks

Member	Shape	Code Check	Loc[in]	LC Shear Check	Loc[in]	Dir	LC Pnc/Om [lb]	Pnt/Om [lb]	Mny/Om [lb-ft]	Mnz/Om [lb-ft]	Vny/Om [lb]	Vnz/Om [lb]	Cb	Eqn		
1	M74	HR300 ALA	0.734	46.375	10	0.06	163.417	y 8	6230.805	14342.564	533.921	934.619	7307.692	3206.154	2.449	H.1-1
2	M43	HR300 ALA	0.734	46.375	10	0.06	163.417	y 8	6230.805	14342.564	533.921	934.619	7307.692	3206.154	2.449	H.1-1
3	M75	HR300 ALA	0.734	46.375	10	0.061	163.417	y 8	6230.805	14342.564	533.921	934.619	7307.692	3206.154	2.449	H.1-1
4	M40	HR300 ALA	0.734	46.375	10	0.061	163.417	y 8	6230.805	14342.564	533.921	934.619	7307.692	3206.154	2.449	H.1-1
5	M55	HR300 ALA	0.734	46.375	10	0.06	48.583	y 10	6230.805	14342.564	533.921	934.619	7307.692	3206.154	2.449	H.1-1
6	M60	HR300 ALA	0.734	46.375	10	0.06	48.583	y 10	6230.805	14342.564	533.921	934.619	7307.692	3206.154	2.449	H.1-1
7	M58	HR300 ALA	0.734	46.375	10	0.061	48.583	y 10	6230.805	14342.564	533.921	934.619	7307.692	3206.154	2.449	H.1-1
8	M59	HR300 ALA	0.734	46.375	10	0.061	48.583	y 10	6230.805	14342.564	533.921	934.619	7307.692	3206.154	2.449	H.1-1
9	M65	HR300 ALA	0.734	46.375	10	0.06	48.583	y 10	6230.805	14342.564	533.921	934.619	7307.692	3206.154	2.449	H.1-1
10	M49	HR300 ALA	0.734	46.375	10	0.06	48.583	y 10	6230.805	14342.564	533.921	934.619	7307.692	3206.154	2.449	H.1-1
11	M66	HR300 ALA	0.734	46.375	10	0.059	48.583	y 10	6230.805	14342.564	533.921	934.619	7307.692	3206.154	2.449	H.1-1
12	M46	HR300 ALA	0.734	46.375	10	0.059	48.583	y 10	6230.805	14342.564	533.921	934.619	7307.692	3206.154	2.449	H.1-1
13	M84	HR300 ALA	0.734	46.375	10	0.06	48.583	y 10	6230.805	14342.564	533.921	934.619	7307.692	3206.154	2.449	H.1-1
14	M37	HR300 ALA	0.734	46.375	10	0.059	48.583	y 10	6230.805	14342.564	533.921	934.619	7307.692	3206.154	2.449	H.1-1
15	M73	HR300 ALA	0.662	46.375	10	0.064	163.417	y 8	6230.805	14342.564	533.921	934.619	7307.692	3206.154	2.564	H.1-1
16	M83	HR300 ALA	0.662	46.375	10	0.064	163.417	y 8	6230.805	14342.564	533.921	934.619	7307.692	3206.154	2.564	H.1-1
17	M111	HR300 ALA	0.63	46.375	10	0.052	48.583	y 10	6230.805	14342.564	533.921	934.619	7307.692	3206.154	2.448	H.1-1
18	M128	HR300 ALA	0.63	46.375	10	0.052	48.583	y 10	6230.805	14342.564	533.921	934.619	7307.692	3206.154	2.448	H.1-1
19	M127	HR300 ALA	0.63	46.375	10	0.052	48.583	y 10	6230.805	14342.564	533.921	934.619	7307.692	3206.154	2.449	H.1-1
20	M126	HR300 ALA	0.63	46.375	10	0.052	48.583	y 10	6230.805	14342.564	533.921	934.619	7307.692	3206.154	2.449	H.1-1
21	M130	HR300 ALA	0.63	46.375	10	0.051	48.583	y 10	6230.805	14342.564	533.921	934.619	7307.692	3206.154	2.449	H.1-1
22	M110	HR300 ALA	0.63	46.375	10	0.051	48.583	y 10	6230.805	14342.564	533.921	934.619	7307.692	3206.154	2.449	H.1-1
23	M93	HR300 ALA	0.619	46.375	10	0.053	48.583	y 10	6230.805	14342.564	533.921	934.619	7307.692	3206.154	2.493	H.1-1
24	M94	HR300 ALA	0.615	46.375	10	0.055	48.583	y 10	6230.805	14342.564	533.921	934.619	7307.692	3206.154	2.457	H.1-1



JOB NO.: U2716.0319.211

PROJECT: Sunturf B6 Ground Mount

SUBJECT: CALCULATIONS

DESIGN APPROACH ASD

CONNECTION CAPACITY

Location: Column Base (set screws)

Connection Type: M16 Conical Set Screws

Tensile Capacity: 2603 lbs (AISC Equation J3-1)

Tension Load: 1801 lbs

Check Connection: 69.2%

Result: **Select M16 Conical Set Screws**

Note: Uplift capacity. FOS of (2)

CONNECTION CAPACITY

Location: Column to Cross Beam

Connection Type: K10341-002

Tensile Capacity: 2195 lbs

Tension Load: 1344 lbs

Check Connection: 61.2%

Result: **Select K10341-002**

Note: Uplift capacity. FOS of (2)



JOB NO.: U2716.0319.211

PROJECT: Sunturf B6 Ground Mount

SUBJECT: CALCULATIONS

CONNECTION CAPACITY

Location: Brace to Column

Connection Type: K10219-001

Capacity: 1483 lbs (AISC Equation J3-1)

Tension Load: 1429 lbs

Check Connection: 96.3%

Result: **Select K10219-001**

Note: Axial capacity. FOS of (1.8)

BOLTED TENSION CONNECTION

Location: Rail to Cross Beam

Bolt Grade: A304 SS (A2-70)

Bolt Diameter: 0.375 in

Number of Bolts: 2

Bolt Capacity: 8410 lbs (AISC Equation J3-1)

Tension Load: 721 lbs

Check Bolt: 8.6%

Result: **Select (2) 0.375 in. dia. A304 SS (A2-70) bolts.**

Note:



PROJECT: Sunturf Package B7 Ground Mount

DRILLED CONCRETE PIER DESIGN

Column Reactions:

Max. Shear, V [k]:	1.2	Max. Down, P _d [k]:	2.6
Max. Moment, M [k-ft]:	0.0	Max. Uplift, P _u [k]:	1.8

Pier Properties:

Pier Shape:	Round	Volume of Concrete [ft ³]:	8
Pier Diameter, b [ft]:	1.5	Volume of Concrete [yd ³]:	0.3
Top of Pier Elevation [ft]:	0.00	Weight of Concrete [k]:	1.2
Pier Depth, d [ft]:	4.5		

Soil Properties:

Allow. Bearing Pressure [psf]:	1,500
1/3 increase for short term loads?	No
Lateral Bearing, S [pcf]:	150
Max. Lateral Bearing (opt'l) [psf]:	
Top Depth to Ignore [ft]:	0
1/3 increase for short term loads?	No
1/2" deflection at t/o pier allowed:	Yes

Optional Parameters for Uplift:

Skin Friction* [psf]:	250
Top Length to Ignore [ft]:	0
1/3 increase for short term loads?	No
Combine w/ Bearing:	No

*per IBC Section 1810.3.3.1.4

Check Bearing:

Bearing Capacity [k]:	5.3
-----------------------	-----

Bearing capacity OK.

Check Uplift:

Uplift Capacity [k]:	6.4
----------------------	-----

Uplift capacity OK.

Check Lateral Bearing:

Top of Pier Constrained?:	No
Applied Lateral Force, P [lb]:	1,221
Point of Application, h [ft]:	0.0
S _{max} [psf]:	
S [psf]:	450
A = 2.34*P/(Sb):	4.23
Required Pier Depth, d _{reqd} [ft]:	4.20

IBC Section 1807.3.2.1

IBC Eq. 18-1

Result: **Lateral bearing capacity OK.**



Vector Structural Engineeri..	Ground Mount	SK - 1
LKN		Feb 2, 2023 at 5:22 PM
U2716.0366.231		Sunturf Ground Mount B7 LF 30de...

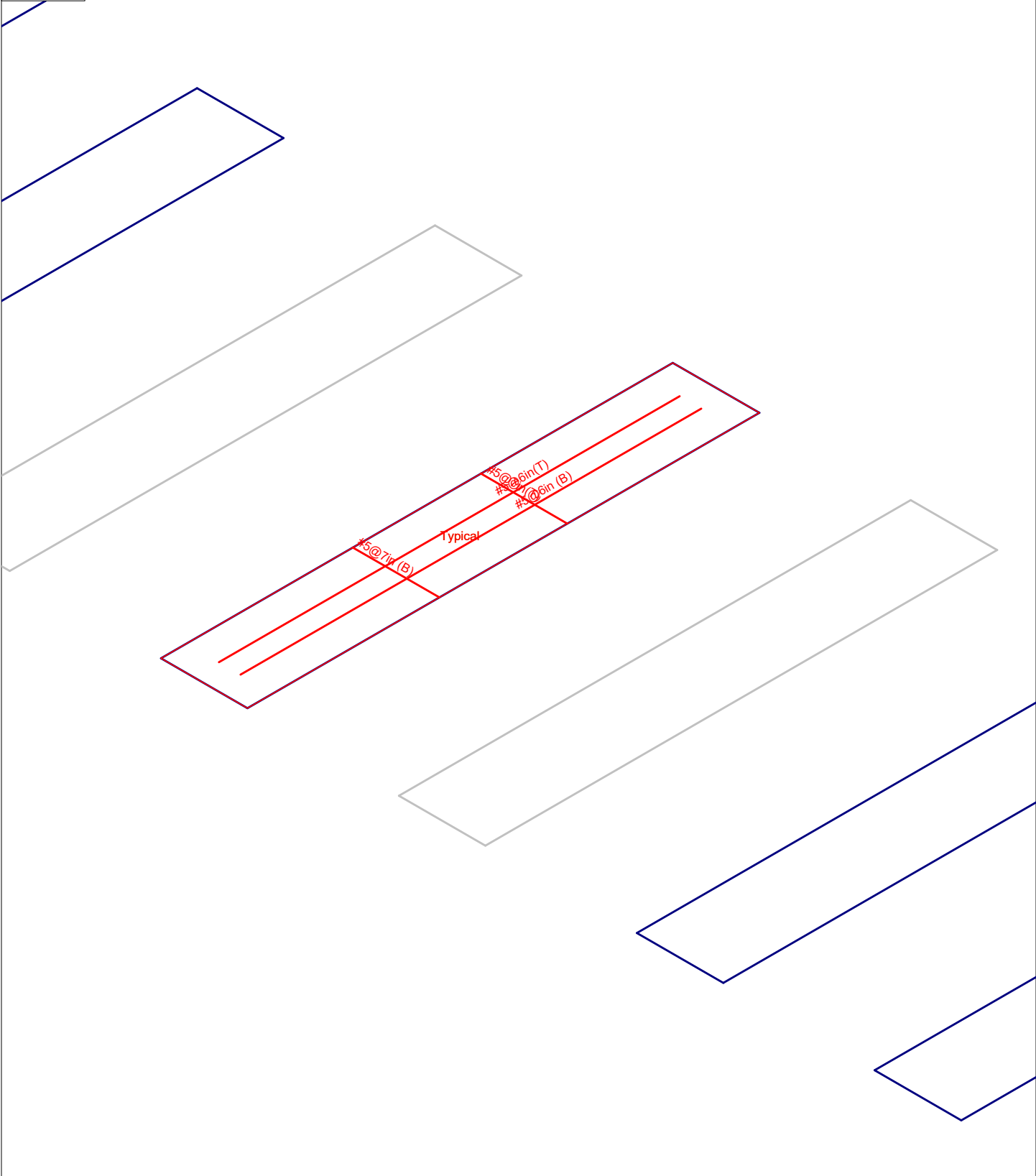
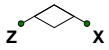

Results for LC 2, 1.0 D

Vector Structural Engineeri...	Ground Mount	SK - 1
LKN		Feb 2, 2023 at 5:23 PM
U2716.0366.231		Sunturf Ground Mount B7 LF 30de...

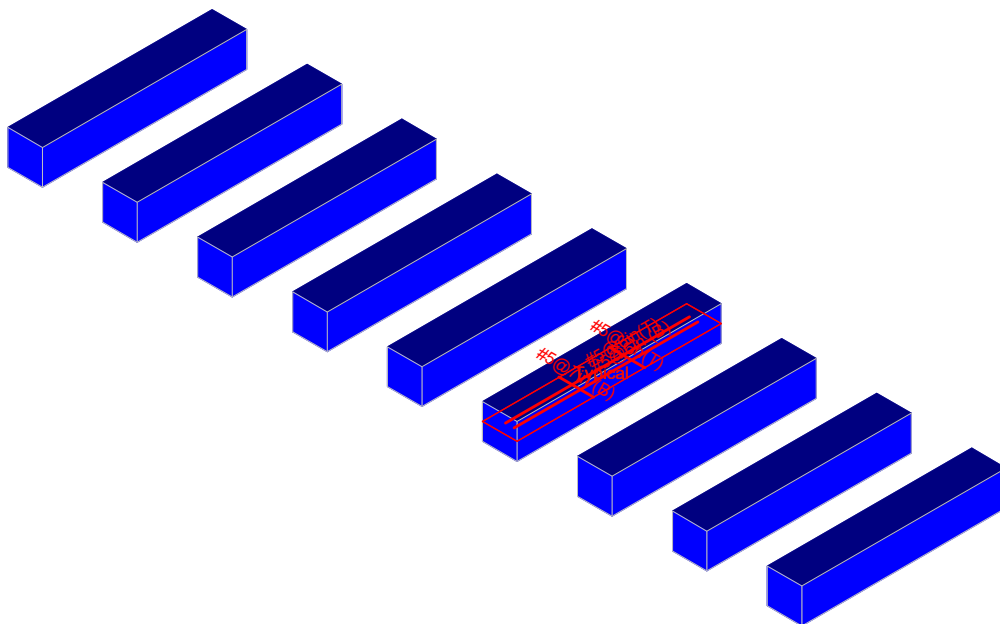
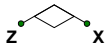

Results for LC 2, 1.0 D

Vector Structural Engineeri...
LKN
U2716.0366.231

Ground Mount

SK - 2

Feb 2, 2023 at 5:23 PM

Sunturf Ground Mount B7 LF 30de...

(Global) Model Settings

Display Sections for Member Calcs	5
Max Internal Sections for Member Calcs	100
Mesh Size (in)	12
Max Iterations	10
Merge Tolerance (in)	0.12
Solver	Sparse Accelerated
Coefficient of Friction	0.3
No. of Shear Regions	4
Shear Region Spacing Increment (in)	4
Min 1 Bar Dia Spacing for Beams?	No
Optimize footings for OTM / Sliding?	Yes
Parme Beta Factor	0.65
Pile Safety Factor	3
Min % Steel for Pedestal	Auto
Concrete Stress Block	Rectangular
Concrete Rebar Set	ASTM A615
Include WWR	No
Concrete Code	ACI 318-14
HR Steel Pile Code	AISC 14th (360-10): ASD
Wood Pile Code	AWC NDS-15: ASD

Concrete Properties

	Label	E [ksi]	G [ksi]	Nu	Therm (/1E...	Density[lb/f...	f'c[psi]	Lambda	Flex Steel[...	Shear Stee...
1	Conc3000NW	3156	1372	0.15	0.6	145	3000	1	60000	60000
2	Conc3500NW	3409	1482	0.15	0.6	145	3500	1	60000	60000
3	Conc4000NW	3644	1584	0.15	0.6	145	4000	1	60000	60000
4	Conc3000LW	2085	907	0.15	0.6	109.999	3000	0.75	60000	60000
5	Conc3500LW	2252	979	0.15	0.6	109.999	3500	0.75	60000	60000
6	Conc4000LW	2408	1047	0.15	0.6	109.999	4000	0.75	60000	60000
7	Conc2500NW	3156	1372	0.15	0.6	145	2500	1	60000	60000

General Design Parameters

	Label	Max Bending Chk	Max Shear Chk	Top Cover[in]	Bottom Cover[in]
1	Typical	1	1	3	3

Slab Rebar Parameters

	Label	Top BarBottom ...	Max Top Bar...	Min Top Bar ...	Max Bot Bar ...	Min Bot Bar ...	Spacing I...	Side Cove...	Rebar Options	
1	Typical	#5	#5	7	3	7	3	1	0	Optimize

Soil Definitions

	Label	Subgrade Modulus[lb/ft^3]	Allowable Bearing[psf]	Depth Properties	Default?
1	Default	1e+5	1500	None	Yes

Slabs

	Label	Thickness [in]	Material	Local Axis Angle...	Analysis Offset [in]	Passive Pressur...	Soil Overburden ...	Icr Factor
1	S1	24	Conc2500NW	0	0	0	0	1
2	S2	24	Conc2500NW	0	0	0	0	1
3	S3	24	Conc2500NW	0	0	0	0	1
4	S4	24	Conc2500NW	0	0	0	0	1
5	S5	24	Conc2500NW	0	0	0	0	1
6	S6	24	Conc2500NW	0	0	0	0	1
7	S7	24	Conc2500NW	0	0	0	0	1



Slabs (Continued)

	Label	Thickness [in]	Material	Local Axis Angle...	Analysis Offset [in]	Passive Pressur...	Soil Overburden ...	lcr Factor
8	S8	24	Conc2500NW	0	0	0	0	1
9	S9	24	Conc2500NW	0	0	0	0	1

Load Combinations

Label	So..	Se..	A...	SF	Cat...	Fac...	Cat...	Fac...	Cat...	Fac...	Cat...	Fac...	Cat...	Fac...	Cat...	Fac...	Cat...	Fac...	Cat...	Fac...
1	ASD Loa...																			
2	1.0 D	Yes	Yes	1.5	DL	1														
3	1.0 D + 1...	Yes	Yes	1.5	DL	1	RLL	1												
4	1.0 D + 0...	Yes	Yes	1.5	DL	1	RLL		OL1	0.6	WLZ	0.6								
5	1.0 D + 0...	Yes	Yes	1.5	DL	1	RLL		OL2	0.6	WLZ	0.6								
6	1.0 D + 0...	Yes	Yes	1.5	DL	1	RLL		OL3	0.6	WLZ	-0.6								
7	1.0 D + 0...	Yes	Yes	1.5	DL	1	RLL		OL4	0.6	WLZ	-0.6								
8	1.0 D + 0...	Yes	Yes	1.5	DL	1	RLL	0.75	OL1	0.45	WLZ	0.45								
9	1.0 D + 0...	Yes	Yes	1.5	DL	1	RLL	0.75	OL2	0.45	WLZ	0.45								
10	1.0 D + 0...	Yes	Yes	1.5	DL	1	RLL	0.75	OL3	0.45	WLZ	-0.45								
11	1.0 D + 0...	Yes	Yes	1.5	DL	1	RLL	0.75	OL4	0.45	WLZ	-0.45								
12	0.9 D + 0...	Yes	Yes		DL	0.9	RLL		OL1	0.6	WLZ	0.6								
13	0.9 D + 0...	Yes	Yes		DL	0.9	RLL		OL2	0.6	WLZ	0.6								
14	0.9 D + 0...	Yes	Yes		DL	0.9	RLL		OL3	0.6	WLZ	-0.6								
15	0.9 D + 0...	Yes	Yes		DL	0.9	RLL		OL4	0.6	WLZ	-0.6								
16																				
17	LRFD Lo...																			
18	1.4 D	Yes			DL	1.4	RLL													
19	1.2 D + 1...	Yes			DL	1.2	RLL	1.6	OL1	0.5	WLZ	0.5								
20	1.2 D + 1...	Yes			DL	1.2	RLL	1.6	OL2	0.5	WLZ	0.5								
21	1.2 D + 1...	Yes			DL	1.2	RLL	1.6	OL3	0.5	WLZ	-0.5								
22	1.2 D + 1...	Yes			DL	1.2	RLL	1.6	OL4	0.5	WLZ	-0.5								
23	1.2 D + 1...	Yes			DL	1.2	RLL		OL1	1	WLZ	1								
24	1.2 D + 1...	Yes			DL	1.2	RLL		OL2	1	WLZ	1								
25	1.2 D + 1...	Yes			DL	1.2	RLL		OL3	1	WLZ	-1								
26	1.2 D + 1...	Yes			DL	1.2	RLL		OL4	1	WLZ	-1								
27	0.9 D + 1...	Yes			DL	0.9	RLL		OL1	1	WLZ	1								
28	0.9 D + 1...	Yes			DL	0.9	RLL		OL2	1	WLZ	1								
29	0.9 D + 1...	Yes			DL	0.9	RLL		OL3	1	WLZ	-1								
30	0.9 D + 1...	Yes			DL	0.9	RLL		OL4	1	WLZ	-1								

Design Strips

	Label	Rebar Angle from Pl...	No. of Design Cuts	Design Rule
1	DS1	0	50	Typical
2	DS2	90	50	Typical

Strip Reinforcing

	Label	UC Top	LC	Top Bars	Governin...	UC Bot	LC	Bot Bars/...	Governin...	UC Shear	LC	Governin...
1	DS1	0.028	21	#5@6in	DS1-X25	0.021	28	#5@6in	DS1-X21	0.042	21	DS1-X13
2	DS2	0	27	#5@7in	DS2-X25	0.001	21	#5@7in	DS2-X25	0.003	21	DS2-X50

Slab Overturning Safety Factors

	LC	Slab	Angle[deg]	Mo-xx[lb-ft]	Ms-xx[lb-ft]	Mo-zz[lb-ft]	Ms-zz[lb-ft]	Ms-xx/Mo-xx	Ms-zz/Mo-zz
1	2	S1	0	0	43070.596	0	7380.793	9.99+	9.99+
2	2	S2	0	0	43052.994	0	7377.903	9.99+	9.99+
3	2	S3	0	0	43058.055	0	7379.253	9.99+	9.99+
4	2	S4	0	0	43024.336	0	7372.366	9.99+	9.99+
5	2	S5	0	0	43058.037	0	7379.26	9.99+	9.99+
6	2	S6	0	0	43052.907	0	7377.855	9.99+	9.99+
7	2	S7	0	0	43070.872	0	7385.538	9.99+	9.99+



Company : Vector Structural Engineering
 Designer : LKN
 Job Number : U2716.0366.231
 Model Name : Ground Mount

Feb 7, 2023
 11:50 AM
 Checked By: _____

Slab Overturning Safety Factors (Continued)

	LC	Slab	Angle[deg]	Mo-xx[lb-ft]	Ms-xx[lb-ft]	Mo-zz[lb-ft]	Ms-zz[lb-ft]	Ms-xx/Mo-xx	Ms-zz/Mo-zz
8	2	S8	0	0	42852.472	0	7327.032	9.99+	9.99+
9	2	S9	0	0	43441.896	0	7480.473	9.99+	9.99+
10	3	S1	0	0	54213.889	0	9653.704	9.99+	9.99+
11	3	S2	0	0	54104.378	0	9634.007	9.99+	9.99+
12	3	S3	0	0	54142.021	0	9652.15	9.99+	9.99+
13	3	S4	0	0	53926.283	0	9603.005	9.99+	9.99+
14	3	S5	0	0	54141.901	0	9643.089	9.99+	9.99+
15	3	S6	0	0	54103.818	0	9641.927	9.99+	9.99+
16	3	S7	0	0	54215.532	0	9691.447	9.99+	9.99+
17	3	S8	0	0	52878.03	0	9301.624	9.99+	9.99+
18	3	S9	0	0	56407.4	0	10211.836	9.99+	9.99+
19	4	S1	0	16906.709	43193.483	1749.69	7380.793	2.555	4.218
20	4	S2	0	16853.9	43161.131	1736.843	7377.963	2.561	4.248
21	4	S3	0	17018.593	43169.186	1748.687	7379.293	2.537	4.22
22	4	S4	0	16467.792	43136.013	1715.253	7372.407	2.619	4.298
23	4	S5	0	17018.939	43169.268	1739.252	7379.299	2.537	4.243
24	4	S6	0	16852.375	43160.754	1739.672	7377.918	2.561	4.241
25	4	S7	0	16917.467	43195.518	1769.023	7385.538	2.553	4.175
26	4	S8	0	15144.706	42908.927	1535.924	7327.2	2.833	4.771
27	4	S9	0	19937.601	43698.132	2087.919	7480.473	2.192	3.583
28	5	S1	0	18400.002	43193.483	1478.628	7380.793	2.347	4.992
29	5	S2	0	18298.392	43161.131	1459.129	7377.963	2.359	5.056
30	5	S3	0	18514.094	43169.186	1468.959	7379.293	2.332	5.023
31	5	S4	0	17857.684	43136.013	1441.714	7372.407	2.416	5.114
32	5	S5	0	18514.553	43169.268	1462.53	7379.299	2.332	5.046
33	5	S6	0	18296.431	43160.754	1456.969	7377.918	2.359	5.064
34	5	S7	0	18413.029	43195.518	1489.139	7385.538	2.346	4.96
35	5	S8	0	16385.475	42908.927	1275.174	7327.2	2.619	5.746
36	5	S9	0	21708.378	43698.132	1750.097	7480.473	2.013	4.274
37	6	S1	0	697.742	44089.527	0	9422.077	9.99+	9.99+
38	6	S2	0	704.258	43908.367	0.06	9404.22	9.99+	9.99+
39	6	S3	0	715.347	43798.834	0.04	9419.389	9.99+	9.99+
40	6	S4	0	684.176	44046.084	0.041	9373.495	9.99+	9.99+
41	6	S5	0	715.339	43798.781	0.039	9408.388	9.99+	9.99+
42	6	S6	0	704.247	43907.829	0.063	9407.472	9.99+	9.99+
43	6	S7	0	698.094	44088.993	0	9449.374	9.99+	9.99+
44	6	S8	0	655.88	43570.589	0.167	9118.944	9.99+	9.99+
45	6	S9	0	800.204	44458.868	0	9916.355	9.99+	9.99+
46	7	S1	0	697.742	47157.604	0	9110.693	9.99+	9.99+
47	7	S2	0	704.258	47014.981	0.06	9103.805	9.99+	9.99+
48	7	S3	0	715.347	46965.468	0.04	9117.115	9.99+	9.99+
49	7	S4	0	684.176	47014.486	0.041	9075.337	9.99+	9.99+
50	7	S5	0	715.339	46965.343	0.039	9105.544	9.99+	9.99+
51	7	S6	0	704.247	47014.616	0.063	9108.248	9.99+	9.99+
52	7	S7	0	698.094	47156.784	0	9141.045	9.99+	9.99+
53	7	S8	0	655.88	46467.991	0.167	8864.585	9.99+	9.99+
54	7	S9	0	800.204	48027.535	0	9557.335	9.99+	9.99+
55	8	S1	0	12680.032	51509.177	1312.267	9085.476	4.062	6.923
56	8	S2	0	12640.425	51337.154	1302.632	9070.026	4.061	6.963
57	8	S3	0	12763.945	51380.153	1311.515	9083.956	4.025	6.926
58	8	S4	0	12350.844	51208.753	1286.44	9045.376	4.146	7.031
59	8	S5	0	12764.204	51380.51	1304.439	9077.161	4.025	6.959
60	8	S6	0	12639.281	51335.566	1304.754	9075.956	4.062	6.956
61	8	S7	0	12688.1	51518.001	1326.767	9114.969	4.06	6.87
62	8	S8	0	11358.53	49991.425	1151.943	8808.102	4.401	7.646
63	8	S9	0	14953.201	53592.798	1565.939	9528.995	3.584	6.085
64	9	S1	0	13800.002	51509.177	1108.971	9085.476	3.733	8.193



Company : Vector Structural Engineering
 Designer : LKN
 Job Number : U2716.0366.231
 Model Name : Ground Mount

Feb 7, 2023
 11:50 AM
 Checked By: _____

Slab Overturning Safety Factors (Continued)

	LC	Slab	Angle[deg]	Mo-xx[lb-ft]	Ms-xx[lb-ft]	Mo-zz[lb-ft]	Ms-zz[lb-ft]	Ms-xx/Mo-xx	Ms-zz/Mo-zz
65	9	S2	0	13723.794	51337.154	1094.347	9070.026	3.741	8.288
66	9	S3	0	13885.571	51380.153	1101.72	9083.956	3.7	8.245
67	9	S4	0	13393.263	51208.753	1081.286	9045.376	3.823	8.365
68	9	S5	0	13885.915	51380.51	1096.897	9077.161	3.7	8.275
69	9	S6	0	13722.323	51335.566	1092.727	9075.956	3.741	8.306
70	9	S7	0	13809.772	51518.001	1116.854	9114.969	3.731	8.161
71	9	S8	0	12289.106	49991.425	956.381	8808.102	4.068	9.21
72	9	S9	0	16281.284	53592.798	1312.573	9528.995	3.292	7.26
73	10	S1	0	523.307	52192.264	0	10616.439	9.99+	9.99+
74	10	S2	0	528.194	51983.061	0.045	10589.719	9.99+	9.99+
75	10	S3	0	536.51	51926.614	0.03	10614.027	9.99+	9.99+
76	10	S4	0	513.132	51967.107	0.031	10546.192	9.99+	9.99+
77	10	S5	0	536.504	51926.493	0.029	10598.978	9.99+	9.99+
78	10	S6	0	528.185	51982.282	0.047	10598.122	9.99+	9.99+
79	10	S7	0	523.57	52192.958	0	10662.846	9.99+	9.99+
80	10	S8	0	491.91	50910.228	0.126	10151.909	9.99+	9.99+
81	10	S9	0	600.153	53928.753	0	11355.907	9.99+	9.99+
82	11	S1	0	523.307	54493.322	0	10382.901	9.99+	9.99+
83	11	S2	0	528.194	54313.022	0.045	10364.408	9.99+	9.99+
84	11	S3	0	536.51	54301.589	0.03	10387.322	9.99+	9.99+
85	11	S4	0	513.132	54193.409	0.031	10322.573	9.99+	9.99+
86	11	S5	0	536.504	54301.414	0.029	10371.845	9.99+	9.99+
87	11	S6	0	528.185	54312.372	0.047	10373.704	9.99+	9.99+
88	11	S7	0	523.57	54493.801	0	10431.6	9.99+	9.99+
89	11	S8	0	491.91	53083.279	0.126	9961.14	9.99+	9.99+
90	11	S9	0	600.153	56605.254	0	11086.642	9.99+	9.99+
91	12	S1	0	16906.709	38874.134	1749.69	6642.714	2.299	3.797
92	12	S2	0	16853.9	38845.018	1736.843	6640.172	2.305	3.823
93	12	S3	0	17018.593	38852.268	1748.687	6641.368	2.283	3.798
94	12	S4	0	16467.792	38822.411	1715.253	6635.171	2.357	3.868
95	12	S5	0	17018.939	38852.342	1739.252	6641.373	2.283	3.819
96	12	S6	0	16852.375	38844.679	1739.672	6640.132	2.305	3.817
97	12	S7	0	16917.467	38875.966	1769.023	6646.984	2.298	3.757
98	12	S8	0	15144.706	38618.035	1535.924	6594.497	2.55	4.294
99	12	S9	0	19937.601	39328.319	2087.919	6732.426	1.973	3.224
100	13	S1	0	18400.002	38874.134	1478.628	6642.714	2.113	4.492
101	13	S2	0	18298.392	38845.018	1459.129	6640.172	2.123	4.551
102	13	S3	0	18514.094	38852.268	1468.959	6641.368	2.099	4.521
103	13	S4	0	17857.684	38822.411	1441.714	6635.171	2.174	4.602
104	13	S5	0	18514.553	38852.342	1462.53	6641.373	2.098	4.541
105	13	S6	0	18296.431	38844.679	1456.969	6640.132	2.123	4.557
106	13	S7	0	18413.029	38875.966	1489.139	6646.984	2.111	4.464
107	13	S8	0	16385.475	38618.035	1275.174	6594.497	2.357	5.171
108	13	S9	0	21708.378	39328.319	1750.097	6732.426	1.812	3.847
109	14	S1	0	697.742	39782.467	0	8683.997	9.99+	9.99+
110	14	S2	0	704.258	39603.067	0.06	8666.43	9.99+	9.99+
111	14	S3	0	715.347	39493.028	0.04	8681.463	9.99+	9.99+
112	14	S4	0	684.176	39743.651	0.041	8636.258	9.99+	9.99+
113	14	S5	0	715.339	39492.978	0.039	8670.462	9.99+	9.99+
114	14	S6	0	704.247	39602.538	0.063	8669.687	9.99+	9.99+
115	14	S7	0	698.094	39781.906	0	8710.82	9.99+	9.99+
116	14	S8	0	655.88	39285.341	0.167	8386.24	9.99+	9.99+
117	14	S9	0	800.204	40114.679	0	9168.308	9.99+	9.99+
118	15	S1	0	697.742	42850.544	0	8372.614	9.99+	9.99+
119	15	S2	0	704.258	42709.681	0.06	8366.015	9.99+	9.99+
120	15	S3	0	715.347	42659.663	0.04	8379.189	9.99+	9.99+
121	15	S4	0	684.176	42712.053	0.041	8338.1	9.99+	9.99+



Company : Vector Structural Engineering
 Designer : LKN
 Job Number : U2716.0366.231
 Model Name : Ground Mount

Feb 7, 2023
 11:50 AM
 Checked By: _____

Slab Overturning Safety Factors (Continued)

	LC	Slab	Angle[deg]	Mo-xx[lb-ft]	Ms-xx[lb-ft]	Mo-zz[lb-ft]	Ms-zz[lb-ft]	Ms-xx/Mo-xx	Ms-zz/Mo-zz
122	15	S5	0	715.339	42659.539	0.039	8367.618	9.99+	9.99+
123	15	S6	0	704.247	42709.325	0.063	8370.462	9.99+	9.99+
124	15	S7	0	698.094	42849.697	0	8402.491	9.99+	9.99+
125	15	S8	0	655.88	42182.743	0.167	8131.882	9.99+	9.99+
126	15	S9	0	800.204	43683.346	0	8809.288	9.99+	9.99+

Slab Sliding Safety Factors

	LC	Slab	Angle[deg]	Va-xx[lb]	Vr-xx[lb]	Va-zz[lb]	Vr-zz[lb]	SR-xx	SR-zz
1	2	S1	0	1.126	2186.974	0	2186.974	9.99+	9.99+
2	2	S2	0	0	2185.707	0	2185.707	9.99+	9.99+
3	2	S3	0	0	2186.04	0	2186.04	9.99+	9.99+
4	2	S4	0	0	2184.344	0	2184.344	9.99+	9.99+
5	2	S5	0	0	2186.041	0	2186.041	9.99+	9.99+
6	2	S6	0	0	2185.695	0	2185.695	9.99+	9.99+
7	2	S7	0	1.127	2187.032	0	2187.032	9.99+	9.99+
8	2	S8	0	2.13	2174.23	0	2174.23	9.99+	9.99+
9	2	S9	0	3.621	2209.181	0	2209.181	9.99+	9.99+
10	3	S1	0	9.09	2750.573	1.092	2750.573	9.99+	9.99+
11	3	S2	0	2.049	2742.255	1.161	2742.255	9.99+	9.99+
12	3	S3	0	2.272	2744.595	0	2744.595	9.99+	9.99+
13	3	S4	0	0	2733.612	0	2733.612	9.99+	9.99+
14	3	S5	0	2.276	2744.603	0	2744.603	9.99+	9.99+
15	3	S6	0	2.042	2742.19	1.186	2742.19	9.99+	9.99+
16	3	S7	0	9.126	2750.895	1.145	2750.895	9.99+	9.99+
17	3	S8	0	17.069	2667.806	0	2667.806	9.99+	9.99+
18	3	S9	0	22.699	2872.35	0	2872.35	9.99+	9.99+
19	4	S1	0	3.407	1753.901	903.737	1753.901	9.99+	1.941
20	4	S2	0	0.715	1757.693	910.737	1757.693	9.99+	1.93
21	4	S3	0	2.366	1756.621	919.172	1756.621	9.99+	1.911
22	4	S4	0	0	1761.993	886.488	1761.993	9.99+	1.988
23	4	S5	0	2.368	1756.615	919.184	1756.615	9.99+	1.911
24	4	S6	0	0.795	1757.729	910.775	1757.729	9.99+	1.93
25	4	S7	0	3.506	1753.713	903.891	1753.713	9.99+	1.94
26	4	S8	0	7.546	1791.303	839.814	1791.303	9.99+	2.133
27	4	S9	0	10.295	1701.909	1061.47	1701.909	9.99+	1.603
28	5	S1	0	1.114	1821.776	771.324	1821.776	9.99+	2.362
29	5	S2	0	0.526	1826.688	778.786	1826.688	9.99+	2.346
30	5	S3	0	1.936	1825.289	789.747	1825.289	9.99+	2.311
31	5	S4	0	0	1829.349	752.266	1829.349	9.99+	2.432
32	5	S5	0	1.307	1825.277	789.756	1825.277	9.99+	2.311
33	5	S6	0	0.432	1826.737	778.829	1826.737	9.99+	2.345
34	5	S7	0	1.239	1821.515	771.444	1821.515	9.99+	2.361
35	5	S8	0	3.103	1857.697	720.035	1857.697	9.99+	2.58
36	5	S9	0	2.846	1778.622	906.53	1778.622	9.99+	1.962
37	6	S1	0	6.415	2692.22	1040.181	2692.22	9.99+	2.588
38	6	S2	0	0.835	2685.06	1048.284	2685.06	9.99+	2.561
39	6	S3	0	2.76	2687.03	1057.995	2687.03	9.99+	2.54
40	6	S4	0	0	2677.088	1020.259	2677.088	9.99+	2.624
41	6	S5	0	2.763	2687.041	1058.008	2687.041	9.99+	2.54
42	6	S6	0	0.928	2684.992	1048.327	2684.992	9.99+	2.561
43	6	S7	0	6.533	2692.565	1040.356	2692.565	9.99+	2.588
44	6	S8	0	13.418	2620.984	966.377	2620.984	9.99+	2.712
45	6	S9	0	19.856	2800.992	1222.45	2800.992	9.99+	2.291
46	7	S1	0	7.338	2616	899.357	2616	9.99+	2.909
47	7	S2	0	1.155	2611.244	905.1	2611.244	9.99+	2.885
48	7	S3	0	2.897	2612.531	910.486	2612.531	9.99+	2.869



Company : Vector Structural Engineering
 Designer : LKN
 Job Number : U2716.0366.231
 Model Name : Ground Mount

Feb 7, 2023
 11:50 AM
 Checked By: _____

Slab Sliding Safety Factors (Continued)

	LC	Slab	Angle[deg]	Va-xx[lb]	Vr-xx[lb]	Va-zz[lb]	Vr-zz[lb]	SR-xx	SR-zz
49	7	S4	0	0	2603.67	885.71	2603.67	9.99+	2.94
50	7	S5	0	2.897	2612.535	910.498	2612.535	9.99+	2.869
51	7	S6	0	1.153	2611.201	905.129	2611.201	9.99+	2.885
52	7	S7	0	7.404	2616.213	899.522	2616.213	9.99+	2.908
53	7	S8	0	14.052	2558.664	833.32	2558.664	9.99+	3.07
54	7	S9	0	26.16	2709.483	1055.278	2709.483	9.99+	2.568
55	8	S1	0	3.699	2284.868	678.621	2284.868	9.99+	3.367
56	8	S2	0	1	2282.107	682.182	2282.107	9.99+	3.345
57	8	S3	0	0.071	2282.892	689.379	2282.892	9.99+	3.312
58	8	S4	0	0	2279.532	664.866	2279.532	9.99+	3.429
59	8	S5	0	0.069	2282.892	689.388	2282.892	9.99+	3.311
60	8	S6	0	0.935	2282.092	682.192	2282.092	9.99+	3.345
61	8	S7	0	3.651	2284.94	678.777	2284.94	9.99+	3.366
62	8	S8	0	6.077	2257.217	629.861	2257.217	9.99+	3.584
63	8	S9	0	7.493	2326.104	796.103	2326.104	9.99+	2.922
64	9	S1	0	5.419	2335.775	579.312	2335.775	9.99+	4.032
65	9	S2	0	1.931	2333.853	583.219	2333.853	9.99+	4.002
66	9	S3	0	0.252	2334.393	592.31	2334.393	9.99+	3.941
67	9	S4	0	0	2330.049	564.2	2330.049	9.99+	4.13
68	9	S5	0	0.727	2334.389	592.317	2334.389	9.99+	3.941
69	9	S6	0	1.856	2333.848	583.232	2333.848	9.99+	4.002
70	9	S7	0	5.351	2335.792	579.442	2335.792	9.99+	4.031
71	9	S8	0	9.409	2307.013	540.026	2307.013	9.99+	4.272
72	9	S9	0	17.348	2383.639	679.898	2383.639	9.99+	3.506
73	10	S1	0	11.066	2988.608	779.317	2988.608	9.99+	3.835
74	10	S2	0	2.163	2977.632	787.084	2977.632	9.99+	3.783
75	10	S3	0	3.774	2980.698	793.497	2980.698	9.99+	3.756
76	10	S4	0	0	2965.853	765.195	2965.853	9.99+	3.876
77	10	S5	0	3.779	2980.712	793.506	2980.712	9.99+	3.756
78	10	S6	0	2.227	2977.539	787.135	2977.539	9.99+	3.783
79	10	S7	0	11.18	2989.079	779.408	2989.079	9.99+	3.835
80	10	S8	0	21.8	2879.478	724.783	2879.478	9.99+	3.973
81	10	S9	0	30.106	3150.417	916.837	3150.417	9.99+	3.436
82	11	S1	0	11.758	2931.443	673.699	2931.443	9.99+	4.351
83	11	S2	0	2.403	2922.271	679.696	2922.271	9.99+	4.299
84	11	S3	0	3.876	2924.824	682.865	2924.824	9.99+	4.283
85	11	S4	0	0	2910.789	664.282	2910.789	9.99+	4.382
86	11	S5	0	3.88	2924.833	682.874	2924.833	9.99+	4.283
87	11	S6	0	2.396	2922.195	679.736	2922.195	9.99+	4.299
88	11	S7	0	11.834	2931.816	673.783	2931.816	9.99+	4.351
89	11	S8	0	22.276	2832.738	624.99	2832.738	9.99+	4.532
90	11	S9	0	34.834	3081.785	791.458	3081.785	9.99+	3.894
91	12	S1	0	3.52	1535.203	903.737	1535.203	9.99+	1.699
92	12	S2	0	0.715	1539.122	910.737	1539.122	9.99+	1.69
93	12	S3	0	2.366	1538.017	919.172	1538.017	9.99+	1.673
94	12	S4	0	0	1543.559	886.488	1543.559	9.99+	1.741
95	12	S5	0	2.368	1538.01	919.184	1538.01	9.99+	1.673
96	12	S6	0	0.795	1539.159	910.775	1539.159	9.99+	1.69
97	12	S7	0	3.619	1535.01	903.891	1535.01	9.99+	1.698
98	12	S8	0	7.759	1573.88	839.814	1573.88	9.99+	1.874
99	12	S9	0	10.657	1480.991	1061.47	1480.991	9.99+	1.395
100	13	S1	0	1.227	1603.078	771.324	1603.078	9.99+	2.078
101	13	S2	0	0.526	1608.117	778.786	1608.117	9.99+	2.065
102	13	S3	0	1.936	1606.685	789.747	1606.685	9.99+	2.034
103	13	S4	0	0	1610.915	752.266	1610.915	9.99+	2.141
104	13	S5	0	1.307	1606.673	789.756	1606.673	9.99+	2.034
105	13	S6	0	0.432	1608.167	778.829	1608.167	9.99+	2.065



Company : Vector Structural Engineering
 Designer : LKN
 Job Number : U2716.0366.231
 Model Name : Ground Mount

Feb 7, 2023
 11:50 AM
 Checked By: _____

Slab Sliding Safety Factors (Continued)

	LC	Slab	Angle[deg]	Va-xx[lb]	Vr-xx[lb]	Va-zz[lb]	Vr-zz[lb]	SR-xx	SR-zz
106	13	S7	0	1.352	1602.812	771.444	1602.812	9.99+	2.078
107	13	S8	0	3.316	1640.274	720.035	1640.274	9.99+	2.278
108	13	S9	0	2.484	1557.704	906.53	1557.704	9.99+	1.718
109	14	S1	0	6.302	2473.522	1040.181	2473.522	9.99+	2.378
110	14	S2	0	0.835	2466.489	1048.284	2466.489	9.99+	2.353
111	14	S3	0	2.76	2468.426	1057.995	2468.426	9.99+	2.333
112	14	S4	0	0	2458.653	1020.259	2458.653	9.99+	2.41
113	14	S5	0	2.763	2468.437	1058.008	2468.437	9.99+	2.333
114	14	S6	0	0.928	2466.422	1048.327	2466.422	9.99+	2.353
115	14	S7	0	6.42	2473.862	1040.356	2473.862	9.99+	2.378
116	14	S8	0	13.205	2403.561	966.377	2403.561	9.99+	2.487
117	14	S9	0	19.494	2580.074	1222.45	2580.074	9.99+	2.111
118	15	S1	0	7.225	2397.302	899.357	2397.302	9.99+	2.666
119	15	S2	0	1.155	2392.673	905.1	2392.673	9.99+	2.644
120	15	S3	0	2.897	2393.927	910.486	2393.927	9.99+	2.629
121	15	S4	0	0	2385.235	885.71	2385.235	9.99+	2.693
122	15	S5	0	2.897	2393.931	910.498	2393.931	9.99+	2.629
123	15	S6	0	1.153	2392.631	905.129	2392.631	9.99+	2.643
124	15	S7	0	7.291	2397.51	899.522	2397.51	9.99+	2.665
125	15	S8	0	13.839	2341.241	833.32	2341.241	9.99+	2.81
126	15	S9	0	25.798	2488.565	1055.278	2488.565	9.99+	2.358

Envelope Slab Soil Pressures

	Label	Max UC	Max LC	Soil Pressure[psf]	Allowable Bearing[psf]	Point
1	S1	0.402	10	602.362	1500	N1
2	S2	0.4	10	599.723	1500	N36
3	S3	0.402	10	602.733	1500	N40
4	S4	0.396	10	593.327	1500	N44
5	S5	0.402	10	602.744	1500	N48
6	S6	0.4	10	599.679	1500	N52
7	S7	0.402	10	602.643	1500	N56
8	S8	0.375	10	563.118	1500	N60
9	S9	0.442	10	662.274	1500	N64



Company:		Date:	2/2/2023
Engineer:		Page:	1/6
Project:			
Address:			
Phone:			
E-mail:			

1. Project information

Customer company:
Customer contact name:
Customer e-mail:
Comment:

Project description:
Location:
Fastening description:

2. Input Data & Anchor Parameters

General

Design method: ACI 318-14
Units: Imperial units

Anchor Information:

Anchor type: Bonded anchor
Material: F1554 Grade 36
Diameter (inch): 0.375
Effective Embedment depth, h_{ef} (inch): 2.375
Code report: ICC-ES ESR-4057
Anchor category: -
Anchor ductility: Yes
 h_{min} (inch): 3.63
 c_{ac} (inch): 3.81
 C_{min} (inch): 1.75
 S_{min} (inch): 1.00

Base Material

Concrete: Normal-weight
Concrete thickness, h (inch): 24.00
State: Cracked
Compressive strength, f'_c (psi): 2500
 $\Psi_{c,v}$: 1.0
Reinforcement condition: B tension, B shear
Supplemental reinforcement: Not applicable
Reinforcement provided at corners: No
Ignore concrete breakout in tension: No
Ignore concrete breakout in shear: No
Hole condition: Dry concrete
Inspection: Periodic
Temperature range, Short/Long: 150/110°F
Ignore 6do requirement: Not applicable
Build-up grout pad: No

Base Plate

Length x Width x Thickness (inch): 4.75 x 4.75 x 0.25

Recommended Anchor

Anchor Name: SET-3G - SET-3G w/ 3/8"Ø F1554 Gr. 36
Code Report: ICC-ES ESR-4057





Company:		Date:	2/2/2023
Engineer:		Page:	2/6
Project:			
Address:			
Phone:			
E-mail:			

Load and Geometry

Load factor source: ACI 318 Section 5.3

Load combination: not set

Seismic design: No

Anchors subjected to sustained tension: No

Apply entire shear load at front row: No

Anchors only resisting wind and/or seismic loads: No

Strength level loads:

N_{ua} [lb]: 3028

V_{uax} [lb]: 2035

V_{uay} [lb]: 73

M_{ux} [ft-lb]: 0

M_{uy} [ft-lb]: 0

M_{uz} [ft-lb]: 0

<Figure 1>

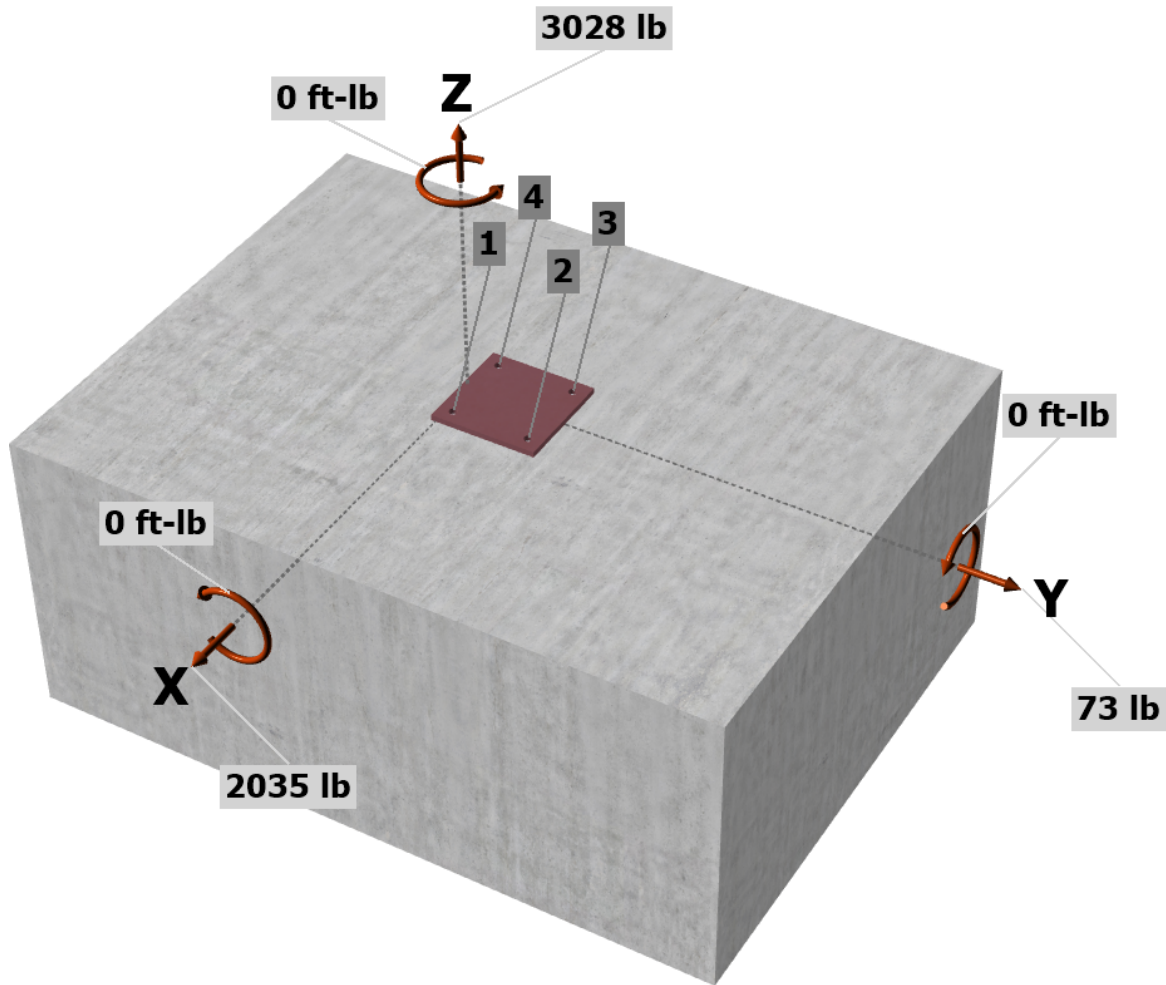

Input data and results must be checked for agreement with the existing circumstances, the standards and guidelines must be checked for plausibility.



Company:		Date:	2/2/2023
Engineer:		Page:	3/6
Project:			
Address:			
Phone:			
E-mail:			

<Figure 2>

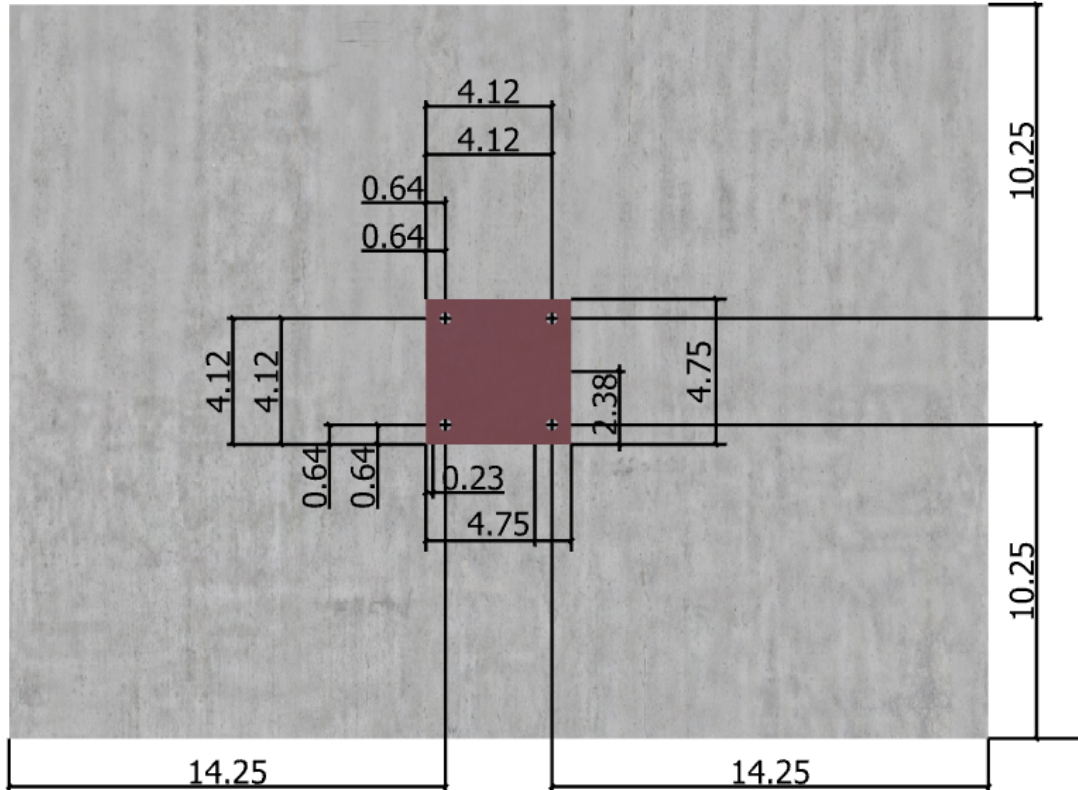



Company:		Date:	2/2/2023
Engineer:		Page:	4/6
Project:			
Address:			
Phone:			
E-mail:			

3. Resulting Anchor Forces

Anchor	Tension load, N _{ua} (lb)	Shear load x, V _{uax} (lb)	Shear load y, V _{uay} (lb)	Shear load combined, $\sqrt{(V_{uax})^2 + (V_{uay})^2}$ (lb)
1	1666.6	823.1	332.6	887.7
2	45.3	194.4	332.6	385.2
3	45.3	194.4	-296.1	354.2
4	1666.6	823.1	-296.1	874.7
Sum	3423.8	2035.0	73.0	2501.9

Maximum concrete compression strain (%): 0.07
 Maximum concrete compression stress (psi): 313
 Resultant tension force (lb): 3424
 Resultant compression force (lb): 396
 Eccentricity of resultant tension forces in x-axis, e'_{Nx} (inch): 1.65
 Eccentricity of resultant tension forces in y-axis, e'_{Ny} (inch): 0.00
 Eccentricity of resultant shear forces in x-axis, e'_{Vx} (inch): 0.00
 Eccentricity of resultant shear forces in y-axis, e'_{Vy} (inch): 0.00

<Figure 3>

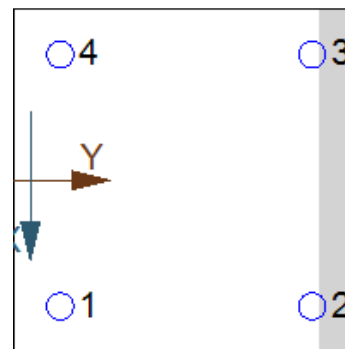

4. Steel Strength of Anchor in Tension (Sec. 17.4.1)

N _{sa} (lb)	φ	φN _{sa} (lb)
4525	0.75	3394

5. Concrete Breakout Strength of Anchor in Tension (Sec. 17.4.2)

$$N_b = K_c \lambda_a \sqrt{f'_c} h_{ef}^{1.5} \text{ (Eq. 17.4.2.2a)}$$

K _c	λ _a	f' _c (psi)	h _{ef} (in)	N _b (lb)
17.0	1.00	2500	2.375	3111

$$\phi N_{cbg} = \phi (A_{Nc} / A_{Nco}) \psi_{ec,N} \psi_{ed,N} \psi_{c,N} \psi_{cp,N} N_b \text{ (Sec. 17.3.1 \& Eq. 17.4.2.1b)}$$

A _{Nc} (in ²)	A _{Nco} (in ²)	C _{a,min} (in)	ψ _{ec,N}	ψ _{ed,N}	ψ _{c,N}	ψ _{cp,N}	N _b (lb)	φ	φN _{cbg} (lb)
112.47	50.77	10.25	0.684	1.000	1.00	1.000	3111	0.65	3063

6. Adhesive Strength of Anchor in Tension (Sec. 17.4.5)

$$\tau_{k,cr} = \tau_{k,cr,short-term} K_{sat} (f'_c / 2,500)^0$$

τ _{k,cr} (psi)	f _{short-term}	K _{sat}	f' _c (psi)	n	τ _{k,cr} (psi)
1346	1.00	1.00	2500	0.24	1346

$$N_{ba} = \lambda_a \tau_{cr} \pi d_a h_{ef} \text{ (Eq. 17.4.5.2)}$$

λ _a	τ _{cr} (psi)	d _a (in)	h _{ef} (in)	N _{ba} (lb)
1.00	1346	0.38	2.375	3766

$$\phi N_{ag} = \phi (A_{Na} / A_{Na0}) \psi_{ec,Na} \psi_{ed,Na} \psi_{cp,Na} N_{ba} \text{ (Sec. 17.3.1 \& Eq. 17.4.5.1b)}$$

A _{Na} (in ²)	A _{Na0} (in ²)	C _{Na} (in)	C _{a,min} (in)	ψ _{ec,Na}	ψ _{ed,Na}	ψ _{cp,Na}	N _{ba} (lb)	φ	φN _{ag} (lb)
197.89	112.09	5.29	10.25	0.763	1.000	1.000	3766	0.55	2789



Anchor Designer™
Software
 Version 3.0.7947.0

Company:		Date:	2/2/2023
Engineer:		Page:	5/6
Project:			
Address:			
Phone:			
E-mail:			

8. Steel Strength of Anchor in Shear (Sec. 17.5.1)

V_{sa} (lb)	ϕ_{grout}	ϕ	$\phi_{grout}\phi V_{sa}$ (lb)
2715	1.0	0.65	1765

9. Concrete Breakout Strength of Anchor in Shear (Sec. 17.5.2)

Shear perpendicular to edge in y-direction:

$V_{by} = \min|7(l_e / d_a)^{0.2} \sqrt{d_a \lambda_a} \sqrt{f_c c_{a1}^{1.5}}; 9 \lambda_a \sqrt{f_c c_{a1}^{1.5}}|$ (Eq. 17.5.2.2a & Eq. 17.5.2.2b)

l_e (in)	d_a (in)	λ_a	f_c (psi)	c_{a1} (in)	V_{by} (lb)
2.38	0.375	1.00	2500	16.00	19842

$\phi V_{cbgy} = \phi (A_{vc} / A_{vco}) \psi_{ec,v} \psi_{ed,v} \psi_{c,v} \psi_{h,v} V_{by}$ (Sec. 17.3.1 & Eq. 17.5.2.1b)

A_{vc} (in ²)	A_{vco} (in ²)	$\psi_{ec,v}$	$\psi_{ed,v}$	$\psi_{c,v}$	$\psi_{h,v}$	V_{by} (lb)	ϕ	ϕV_{cbgy} (lb)
575.52	1152.00	1.000	0.828	1.000	1.000	19842	0.70	5746

Shear perpendicular to edge in x-direction:

$V_{bx} = \min|7(l_e / d_a)^{0.2} \sqrt{d_a \lambda_a} \sqrt{f_c c_{a1}^{1.5}}; 9 \lambda_a \sqrt{f_c c_{a1}^{1.5}}|$ (Eq. 17.5.2.2a & Eq. 17.5.2.2b)

l_e (in)	d_a (in)	λ_a	f_c (psi)	c_{a1} (in)	V_{bx} (lb)
2.38	0.375	1.00	2500	13.73	15773

$\phi V_{cbgx} = \phi (A_{vc} / A_{vco}) \psi_{ec,v} \psi_{ed,v} \psi_{c,v} \psi_{h,v} V_{bx}$ (Sec. 17.3.1 & Eq. 17.5.2.1b)

A_{vc} (in ²)	A_{vco} (in ²)	$\psi_{ec,v}$	$\psi_{ed,v}$	$\psi_{c,v}$	$\psi_{h,v}$	V_{bx} (lb)	ϕ	ϕV_{cbgx} (lb)
658.63	848.31	0.950	0.908	1.000	1.000	15773	0.70	7394

Shear parallel to edge in x-direction:

$V_{by} = \min|7(l_e / d_a)^{0.2} \sqrt{d_a \lambda_a} \sqrt{f_c c_{a1}^{1.5}}; 9 \lambda_a \sqrt{f_c c_{a1}^{1.5}}|$ (Eq. 17.5.2.2a & Eq. 17.5.2.2b)

l_e (in)	d_a (in)	λ_a	f_c (psi)	c_{a1} (in)	V_{by} (lb)
2.38	0.375	1.00	2500	10.25	10174

$\phi V_{cbgx} = \phi (2)(A_{vc} / A_{vco}) \psi_{ec,v} \psi_{ed,v} \psi_{c,v} \psi_{h,v} V_{by}$ (Sec. 17.3.1, 17.5.2.1(c) & Eq. 17.5.2.1b)

A_{vc} (in ²)	A_{vco} (in ²)	$\psi_{ec,v}$	$\psi_{ed,v}$	$\psi_{c,v}$	$\psi_{h,v}$	V_{by} (lb)	ϕ	ϕV_{cbgx} (lb)
491.69	472.78	1.000	1.000	1.000	1.000	10174	0.70	14813

Shear parallel to edge in y-direction:

$V_{bx} = \min|7(l_e / d_a)^{0.2} \sqrt{d_a \lambda_a} \sqrt{f_c c_{a1}^{1.5}}; 9 \lambda_a \sqrt{f_c c_{a1}^{1.5}}|$ (Eq. 17.5.2.2a & Eq. 17.5.2.2b)

l_e (in)	d_a (in)	λ_a	f_c (psi)	c_{a1} (in)	V_{bx} (lb)
2.38	0.375	1.00	2500	14.25	16678

$\phi V_{cbgy} = \phi (2)(A_{vc} / A_{vco}) \psi_{ec,v} \psi_{ed,v} \psi_{c,v} \psi_{h,v} V_{bx}$ (Sec. 17.3.1, 17.5.2.1(c) & Eq. 17.5.2.1b)

A_{vc} (in ²)	A_{vco} (in ²)	$\psi_{ec,v}$	$\psi_{ed,v}$	$\psi_{c,v}$	$\psi_{h,v}$	V_{bx} (lb)	ϕ	ϕV_{cbgy} (lb)
512.57	913.78	1.000	1.000	1.000	1.000	16678	0.70	13097

10. Concrete Pryout Strength of Anchor in Shear (Sec. 17.5.3)

$\phi V_{cp} = \phi \min|k_{cp} N_a; k_{cp} N_{cb}| = \phi \min|k_{cp} (A_{Na} / A_{Na0}) \psi_{ed,Na} \psi_{cp,Na} N_{ba}; k_{cp} (A_{Nc} / A_{Nco}) \psi_{ed,N} \psi_{c,N} \psi_{cp,N} N_b|$ (Sec. 17.3.1 & Eq. 17.5.3.1a)

k_{cp}	A_{Na} (in ²)	A_{Na0} (in ²)	$\psi_{ed,Na}$	$\psi_{cp,Na}$	N_{ba} (lb)	N_a (lb)
1.0	49.47	112.09	1.000	1.000	3766	1662

A_{Nc} (in ²)	A_{Nco} (in ²)	$\psi_{ed,N}$	$\psi_{c,N}$	$\psi_{cp,N}$	N_b (lb)	N_{cb} (lb)	ϕ	ϕV_{cp} (lb)
28.12	50.77	1.000	1.000	1.000	3111	1723	0.70	1164

Input data and results must be checked for agreement with the existing circumstances, the standards and guidelines must be checked for plausibility.



Company:		Date:	2/2/2023
Engineer:		Page:	6/6
Project:			
Address:			
Phone:			
E-mail:			

11. Results

Interaction of Tensile and Shear Forces (Sec. 17.6.)

Tension	Factored Load, N_{ua} (lb)	Design Strength, ϕN_n (lb)	Ratio	Status	
Steel	1667	3394	0.49	Pass	
Concrete breakout	3424	3063	1.12	Fail	
Adhesive	3424	2789	1.23	Fail (Governs)	
Shear	Factored Load, V_{ua} (lb)	Design Strength, ϕV_n (lb)	Ratio	Status	
Steel	888	1765	0.50	Pass	
T Concrete breakout y+	665	5746	0.12	Pass	
T Concrete breakout x+	2035	7394	0.28	Pass	
Concrete breakout x+	665	14813	0.04	Pass	
Concrete breakout y-	1646	13097	0.13	Pass	
Concrete breakout, combined	-	-	0.30	Pass	
Pryout	888	1164	0.76	Pass (Governs)	
Interaction check	$N_{ua}/\phi N_n$	$V_{ua}/\phi V_n$	Combined Ratio	Permissible	Status
Sec. 17.6..3	1.23	0.76	199.1%	1.2	Fail

FAIL! Selected anchor type and embedment do not meet the selected design criteria.

12. Warnings

- Designer must exercise own judgement to determine if this design is suitable.
- Refer to manufacturer's product literature for hole cleaning and installation instructions.