



Project Number: U2716-0281-211

May 3, 2023

Sunmodo
14800 NE 65th Street
Vancouver, WA 98682

**REFERENCE: Sunmodo Sunturf Ground Mount A10 (85x45)
Ground Mount PV Array Installation**

To Whom It May Concern:

Per request of Sunmodo, we have been asked to prepare the structural design of a ground-mounted PV solar array system with several foundation options as shown in the attached calculations. Vector Structural Engineering requires that we review each site-specific install, and we are not liable for installs at site specific locations we have not reviewed. The following design parameters are used in our analysis:

- Code: International Building Code, 2018 Edition (2018 IBC)
- Minimum Design Loads for Buildings and Other Structures (ASCE 7-16)
- Design wind speed for risk category I structures: 115 mph
- Wind exposure: C
- Ground snow load: 50 psf
- The ground screws and helical piers must be tested to 1.5 times uplift and 2.0 times lateral reactions found in the table below. A minimum of one ground screw or helical pier must be tested.

Load (ASD)	Value (lbs)	Factor of Safety	Test Value (lbs)
UPLIFT	2800	1.5	4200
LATERAL	1880	2	3760

Foundation concrete shall have a minimum compressive strength of 2500 psi at 28 days. Cement for all concrete shall be Type I or II with a minimum of 6% entrained air with a water/cement ratio of 0.50. Maximum aggregate size shall be 3/4". No special inspection of concrete strength is required.

Footings are designed based on an allowable soil bearing pressure of 1500 psf an allowable skin friction of 250 psf, an allowable lateral bearing pressure of 150 pcf, and a coefficient of friction of 0.3. Vector Structural Engineering strongly recommends independent soils testing be performed by a licensed geotechnical engineer to verify the assumed soil parameters.

All ground mounts are to be installed per manufacturer’s recommendations. The use of solar panel support span tables provided by the manufacturer is allowed only where the site conditions and solar panel configuration match the description of the span tables. Electrical engineering is beyond our scope. All work performed must be in accordance with accepted industry-wide methods and applicable safety standards. Vector Structural Engineering assumes no responsibility for improper installation of the solar panels.

Very truly yours,

VECTOR STRUCTURAL ENGINEERING, LLC
NE Firm License: CA2208

Trevor Hawkes, P.E.
License: E-17127 - Expires: 12/31/2023
Project Engineer

Enclosures

TPH/cjt



05/03/2023



JOB NO. U2716-0281-211
 PROJECT SUNMODO SUNTURF GROUND MOUNTS A10
 SUBJECT ALL OPTIONS

651 W GALENA PARK BLVD. #101 (801) 990-1775
 DRAPER, UTAH 84020 (801) 990-1776 FAX

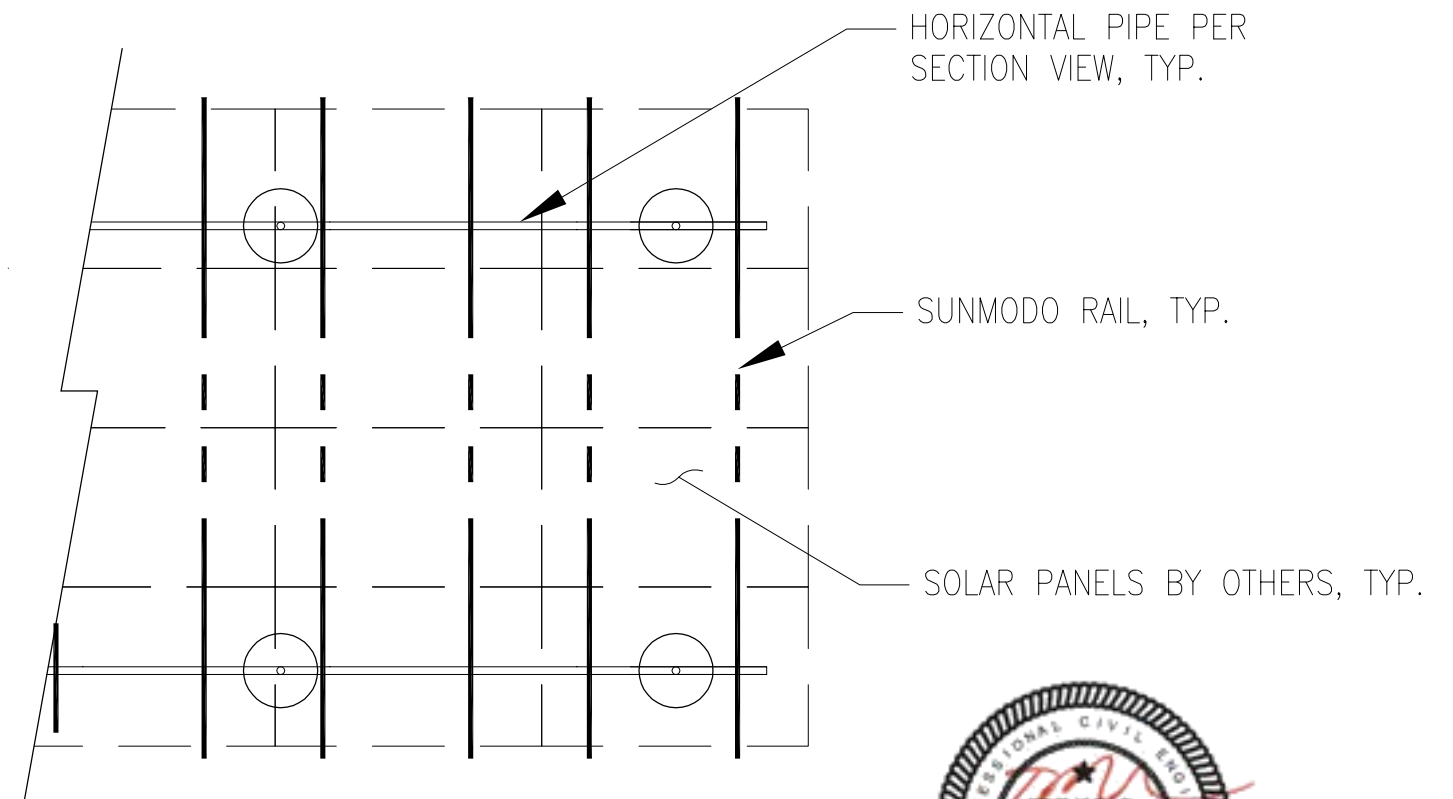
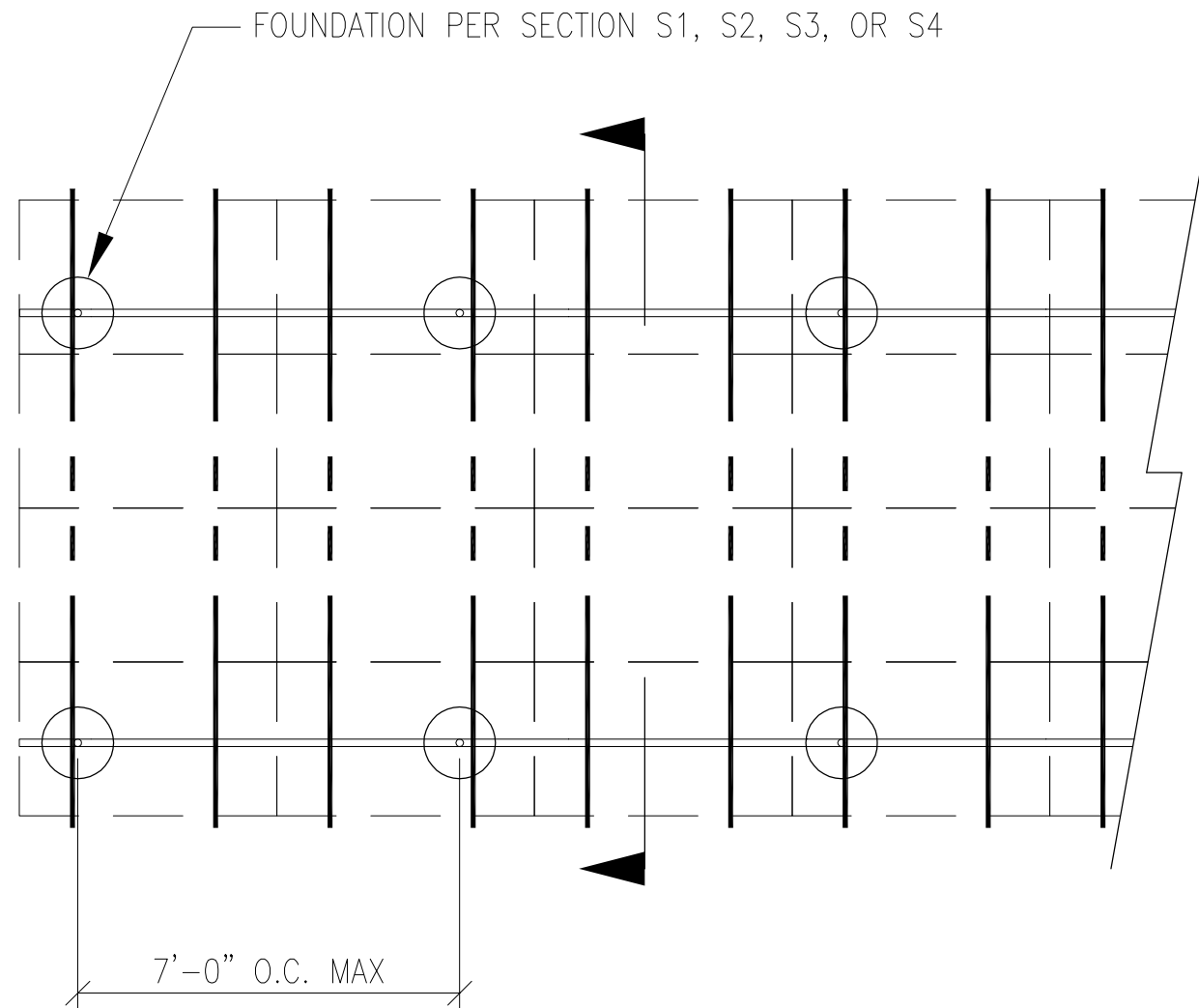

05/03/2023

PV ARRAY PLAN

N.T.S.

P1

Vector Engineers requires that we review each site specific install and is not liable for installs at site specific locations we have not reviewed.

PROJECT SUNMODO SUNTURF GROUND MOUNTS A10

SUBJECT DRILLED PIER OPTION

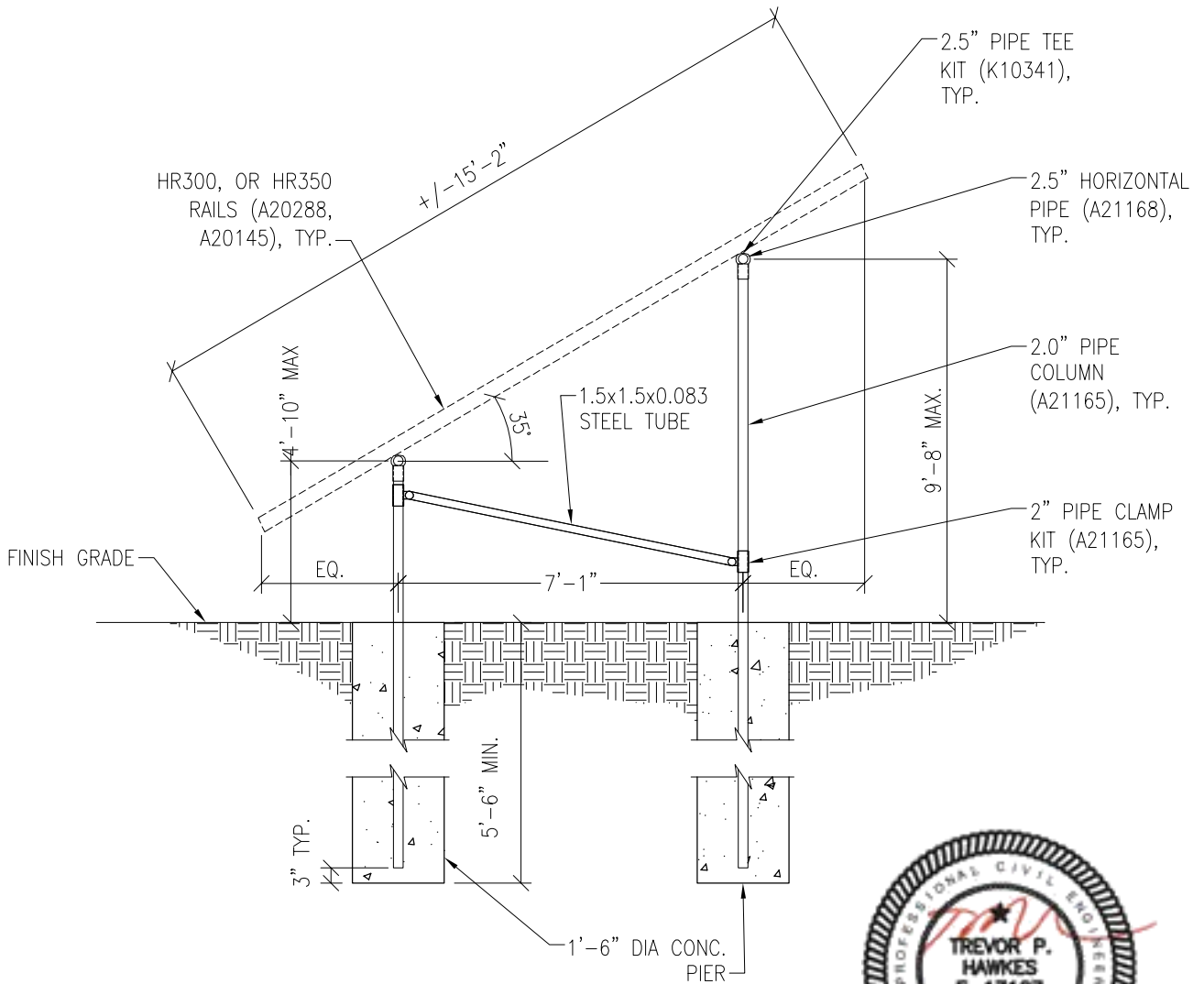

05/03/2023

Vector Engineers requires that we review each site specific install and is not liable for installs at site specific locations we have not reviewed.

PV ARRAY SECTION

N.T.S.

S1



JOB NO. U2716-0281-211

PROJECT SUNMODO SUNTURF GROUND MOUNTS A10

SUBJECT HELICAL PIER OPTION

NOTES:

1. For ground mount components see Section S1.
2. A minimum of (1) installed helical pier must be tested as follows:
 - 2.1. Safety factor for uplift to be 1.5
 - 2.2. S.F. for lateral loads to be 2.0
 - 2.3. Upward deflection limit = 1/2"
 - 2.4. Lateral deflection limit = 1"
 - 2.5. The load tests must be performed by an approved contractor

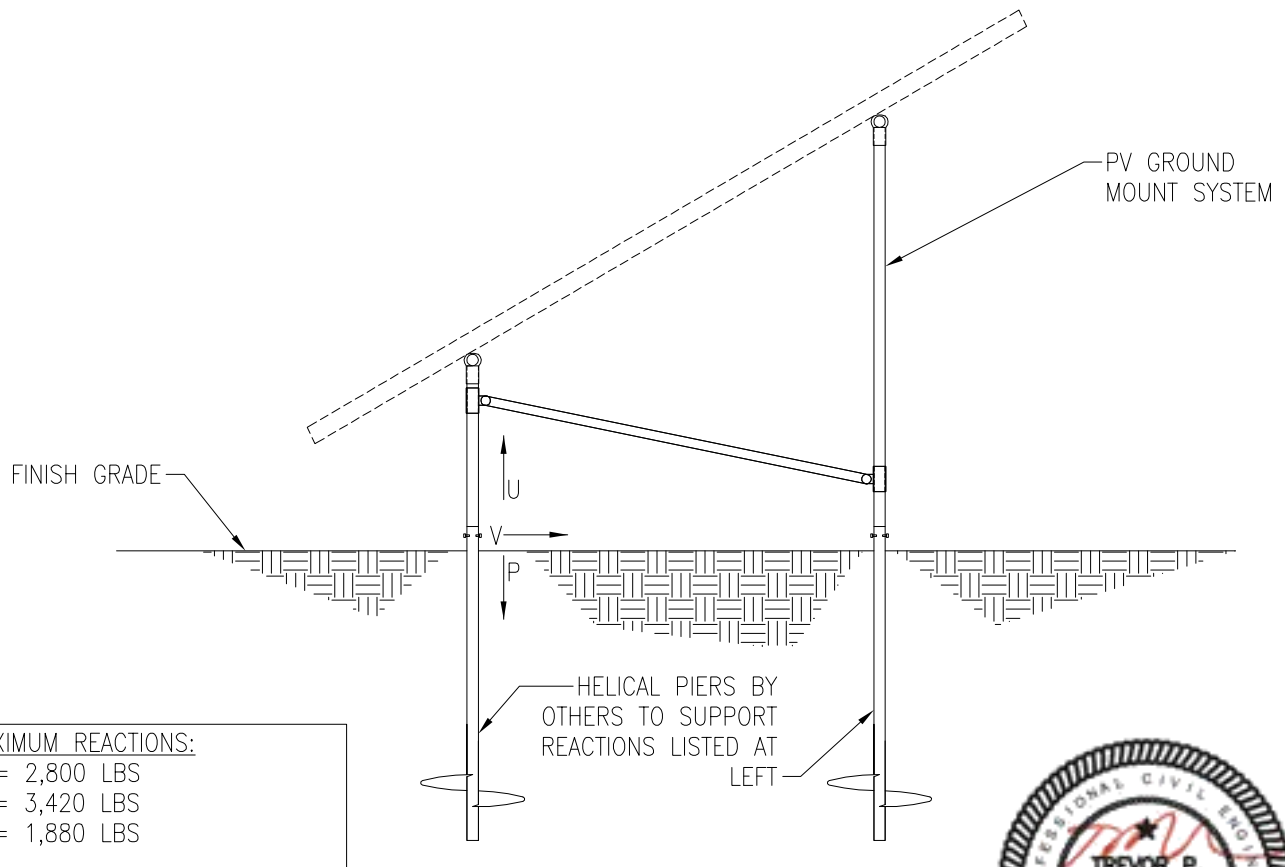

MAXIMUM REACTIONS:
 U = 2,800 LBS
 P = 3,420 LBS
 V = 1,880 LBS



05/03/2023

Vector Engineers requires that we review each site specific install and is not liable for installs at site specific locations we have not reviewed.

PV ARRAY SECTION

N.T.S.

S2

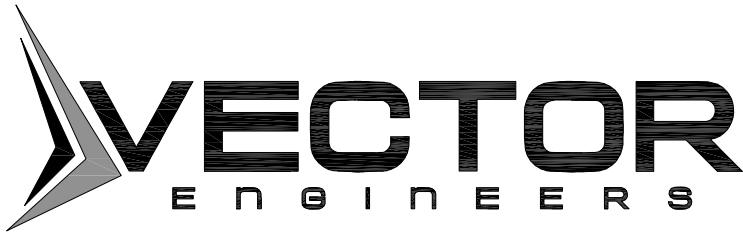

JOB NO. U2716-281-211

PROJECT SUNMODO SUNTURF GROUND MOUNTS A10

SUBJECT GROUND SCREW OPTION

NOTES:

1. For ground mount components see Section S1.
2. A minimum of (1) installed ground screw must be tested as follows:
 - 2.1. Safety factor for uplift to be 1.5
 - 2.2. S.F. for lateral loads to be 2.0
 - 2.3. Upward deflection limit = 1/2"
 - 2.4. Lateral deflection limit = 1"
 - 2.5. The load tests must be performed by an approved contractor

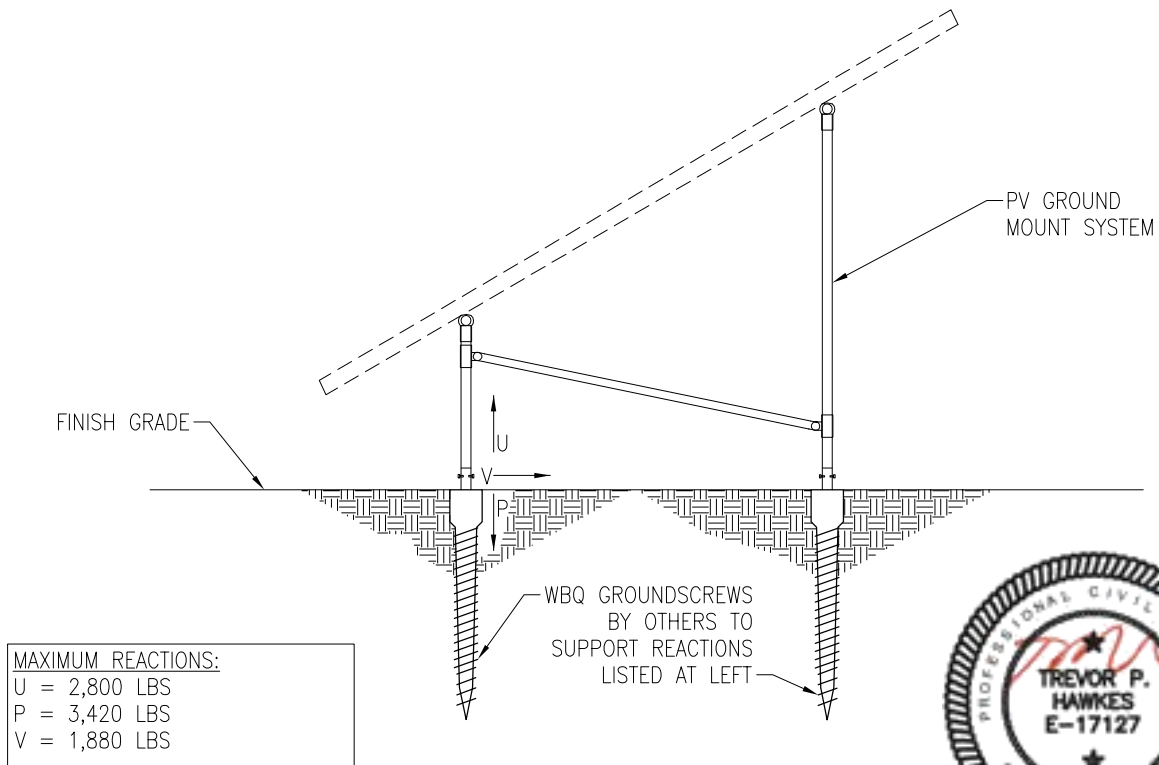

05/03/2023

Vector Engineers requires that we review each site specific install and is not liable for installs at site specific locations we have not reviewed.

PV ARRAY SECTION

N.T.S.

S3

651 W GALENA PARK BLVD. #101
 DRAPER, UTAH 84020

(801) 990-1775
 (801) 990-1776 FAX

WWW.VECTORSE.COM



JOB NO. U2716-0281-211

PROJECT SUNMODO SUNTURF GROUND MOUNTS A10

SUBJECT BALLASTED BLOCK OPTION

NOTES:

1. For ground mount components see Section S1.

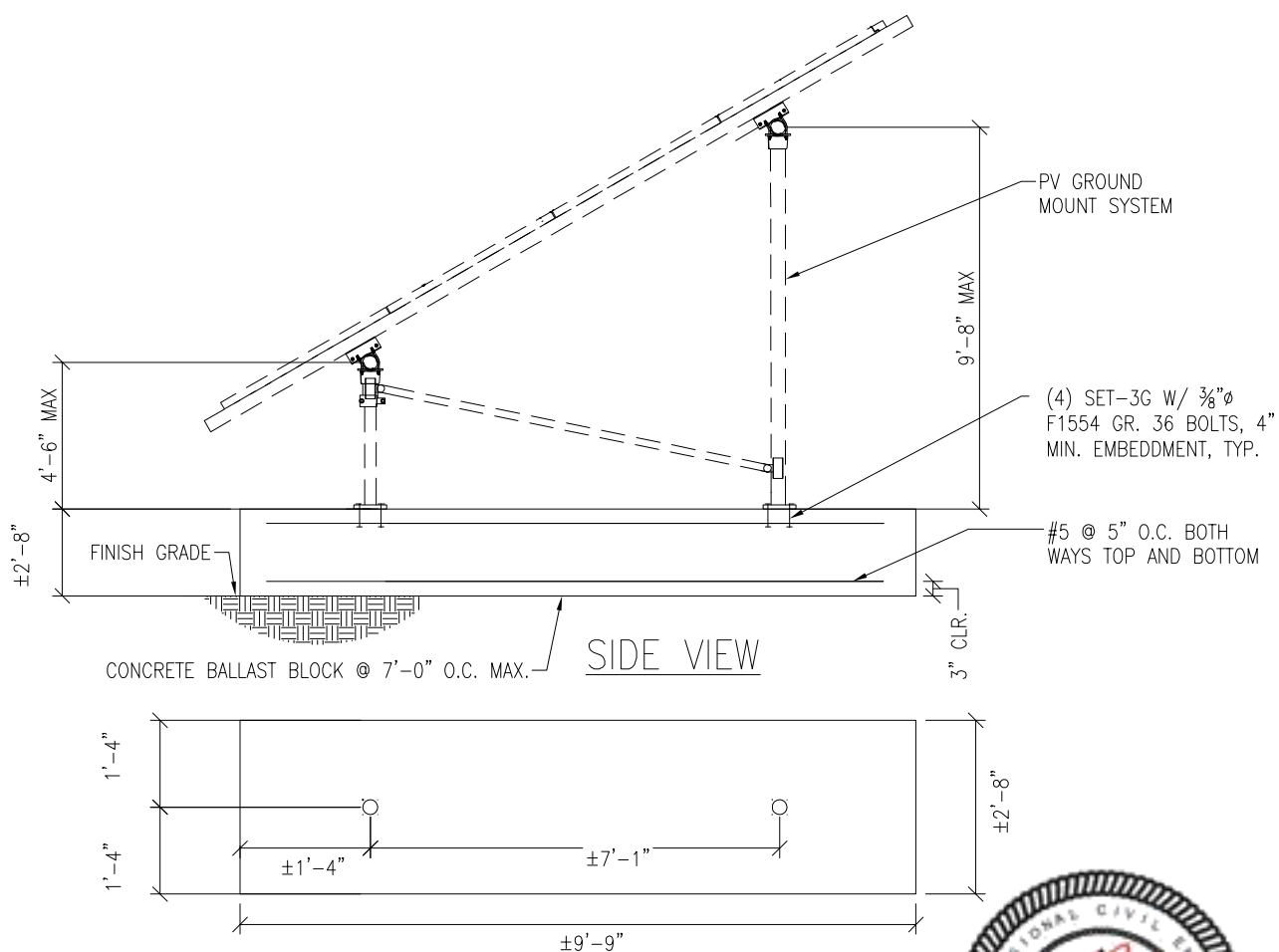

Vector Engineers requires that we review each site specific install and is not liable for installs at site specific locations we have not reviewed.



PV ARRAY SECTION

05/03/2023

S4

N.T.S.

651 W GALENA PARK BLVD. #101
 DRAPER, UTAH 84020

(801) 990-1775
 (801) 990-1776 FAX

WWW.VECTORSE.COM



JOB NO.: U2716.0281.211
SUBJECT: SNOW LOADS

PROJECT: Sunturf Package A10 Ground Mount

SNOW LOADS

Calculations Per:	ASCE 7-16	
Snow Ground Load, p_g [psf]:	50.0	(Section 7.2)
Risk Category:	I	(Table 1.5-1)
Importance Factor, I_s :	0.8	(Table 1.5-2)
Terrain Category:	C	(Section 26.7)
Exposure of Roof:	Fully Exposed	(Table 7-3.1)
Exposure Factor, C_e :	0.9	(Table 7-3.1)
Thermal Factor, C_t :	1.2	(Table 7-3.2)
Flat Roof Snow Load, p_f [psf]:	30	(Equation 7.3-1)
Min. Roof Snow Load, p_m [psf]:	0	(Section 7.3.4)
Panel Slope from Horizontal [°]:	35.0	
Unobstructed Slippery Surface?	Yes	(Section 7.4)
Slope Factor Figure:	Figure 7-2c	(of Figure 7.4-1 - See Section 7.4)
Roof Slope Factor, C_s :	0.64	
Sloped Roof Snow Load, p_s [psf]:	19	(Equation 7.4-1)
Design Snow Load, S [psf]:	19	(1.0 Snow)



JOB NO.: U2716.0281.211
SUBJECT: WIND PRESSURES

PROJECT: Sunturf Package A10 Ground Mount

WIND PRESSURES

Calculations per:	ASCE 7-16	
Design Wind Speed, V [mph]:	115	
Risk Category:	I	(Table 1.5-1)
Exposure Category:	C	(Section 26.7)
Elevation [ft]:	1052.8	
Ground Elevation Factor, K_e :	1.00	(Table 26.9-1)
α :	9.5	(Table 26.11-1)
z_g [ft]:	900	(Table 26.11-1)
Velocity Pressure Exposure Coefficient, K_h :	0.85	(Table 26.10-1)
Topographic Factor, K_{ht} :	1.0	(Section 26.8)
Wind Directionality Factor, K_d :	0.85	(Table 26.6-1)
Internal Pressure Coefficient, GC_{pi} :	0.00	(Figure 26.13-1)
Velocity Pressure, q_h [psf]:	24.43	(Equation 26.10-1)
Gust Effect Factor, G:	0.85	(Section 26.11.4)
Panel Slope [degrees]:	35.0	
Wind Flow:	Clear	
Roof Configuration:	Monoslope	

Wind Pressures in Transverse (N-S) Direction

Net Pressure Coefficients per Figure 27.3-4

Clear Wind Flow	C_{NW}	C_{NL}
Case 1 ($\gamma = 0^\circ$, Load Case A)	-1.8	-1.8
Case 2 ($\gamma = 0^\circ$, Load Case B)	-2.4	-0.6
Case 3 ($\gamma = 180^\circ$, Load Case A)	2.1	2.1
Case 4 ($\gamma = 180^\circ$, Load Case B)	2.7	1.1

Design Wind Pressures per Equation 27.3-2 [psf]

Clear Wind Flow	$q_h GC_{NW}$	$q_h GC_{NL}$
Case 1 ($\gamma = 0^\circ$, Load Case A)	-37.4	-37.4
Case 2 ($\gamma = 0^\circ$, Load Case B)	-49.8	-12.5
Case 3 ($\gamma = 180^\circ$, Load Case A)	43.6	43.6
Case 4 ($\gamma = 180^\circ$, Load Case B)	56.1	22.8
Case 5 ($\gamma = 0^\circ$, 16 psf Min. Horiz.)	-16.0	-16.0
Case 6 ($\gamma = 180^\circ$, 16 psf Min. Horiz)	16.0	16.0



JOB NO.: U2716-0281-211

DESIGNED: STB

Foundation Option 1: Drilled Concrete Pier



JOB NO.: U2716.0281.211
SUBJECT: CONC. PIER

PROJECT: Sunturf Package A10 Ground Mount

DRILLED CONCRETE PIER DESIGN

Column Reactions:

Max. Shear, V [k]:	1.9	Max. Down, P_d [k]:	3.4
Max. Moment, M [k-ft]:	0.0	Max. Uplift, P_u [k]:	2.8

Pier Properties:

Pier Shape:	Round	Volume of Concrete [ft ³]:	10
Pier Diameter, b [ft]:	1.5	Volume of Concrete [yd ³]:	0.4
Top of Pier Elevation [ft]:	0.00	Weight of Concrete [k]:	1.5
Pier Depth, d [ft]:	5.5		

Soil Properties:

Allow. Bearing Pressure [psf]:	1,500	<u>Optional Parameters for Uplift:</u>	
1/3 increase for short term loads?	No	Skin Friction* [psf]:	250
Lateral Bearing, S [pcf]:	150	Top Length to Ignore [ft]:	0
Max. Lateral Bearing (opt'l) [psf]:		1/3 increase for short term loads?	No
Top Depth to Ignore [ft]:	0	Combine w/ Bearing:	No
1/3 increase for short term loads?	No		
1/2" deflection at t/o pier allowed:	Yes		

*per IBC Section 1810.3.3.1.4

Check Bearing:

Bearing Capacity [k]: 6.5

Bearing capacity OK.

Check Uplift:

Uplift Capacity [k]: 7.8

Uplift capacity OK.

Check Lateral Bearing:

Top of Pier Constrained?:	No	IBC Section 1807.3.2.1
Applied Lateral Force, P [lb]:	1,880	
Point of Application, h [ft]:	0.0	
S_{max} [psf]:		
S [psf]:	550	
$A = 2.34 * P / (S_b)$:	5.33	
Required Pier Depth, d_{reqd} [ft]:	5.30	IBC Eq. 18-1

Result: **Lateral bearing capacity OK.**



JOB NO.: U2716-0281-211

DESIGNED: STB

Foundation Option 2: Helical Pier

The ground screws and helical piers must be tested to 1.5 times uplift and 2.0 times lateral reactions found in the table below. A minimum of one ground screw or helical pier must be tested.

Load (ASD)	Value (lbs)	Factor of Safety	Test Value (lbs)
UPLIFT	2800	1.5	4200
LATERAL	1880	2	3760



JOB NO.: U2716-0281-211

DESIGNED: STB

Foundation Option 3: Ground Screw

The ground screws and helical piers must be tested to 1.5 times uplift and 2.0 times lateral reactions found in the table below. A minimum of one ground screw or helical pier must be tested.

Load (ASD)	Value (lbs)	Factor of Safety	Test Value (lbs)
UPLIFT	2800	1.5	4200
LATERAL	1880	2	3760



JOB NO.: U2716-0281-211

DESIGNED: STB

Foundation Option 4: Ballasted Block

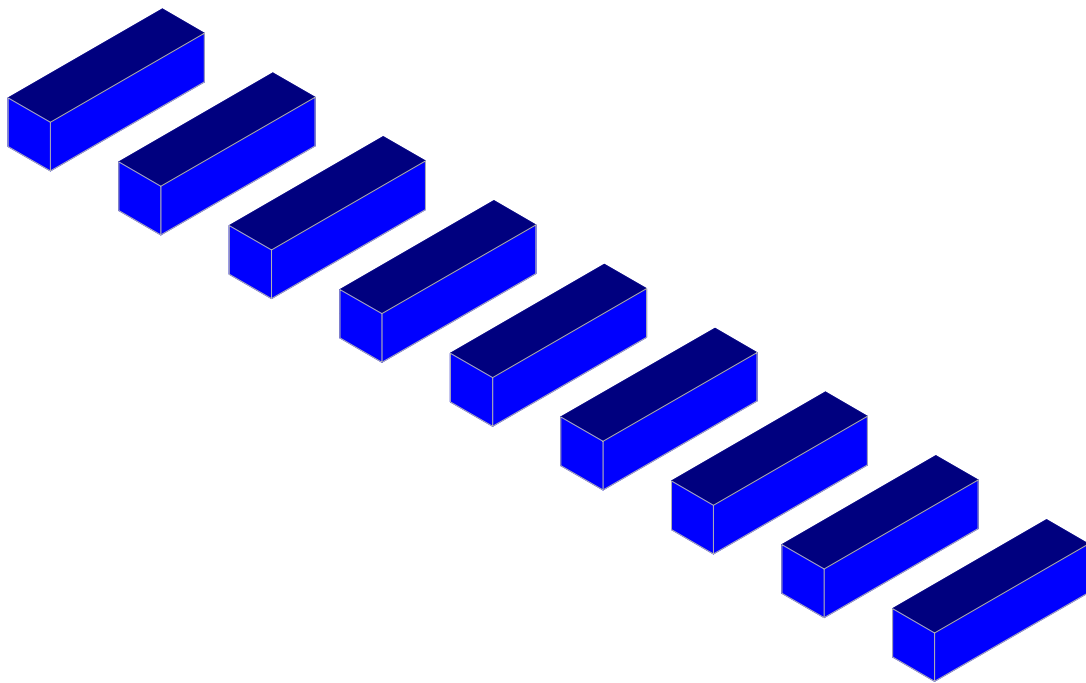

Results for LC 2, 1.0 D

Vector Structural Engineeri..	Ground Mount	SK - 2
STB		Mar 30, 2021 at 3:44 PM
U2716.0281.211		Sunmodo Sunturf A10 (85x45).r3d

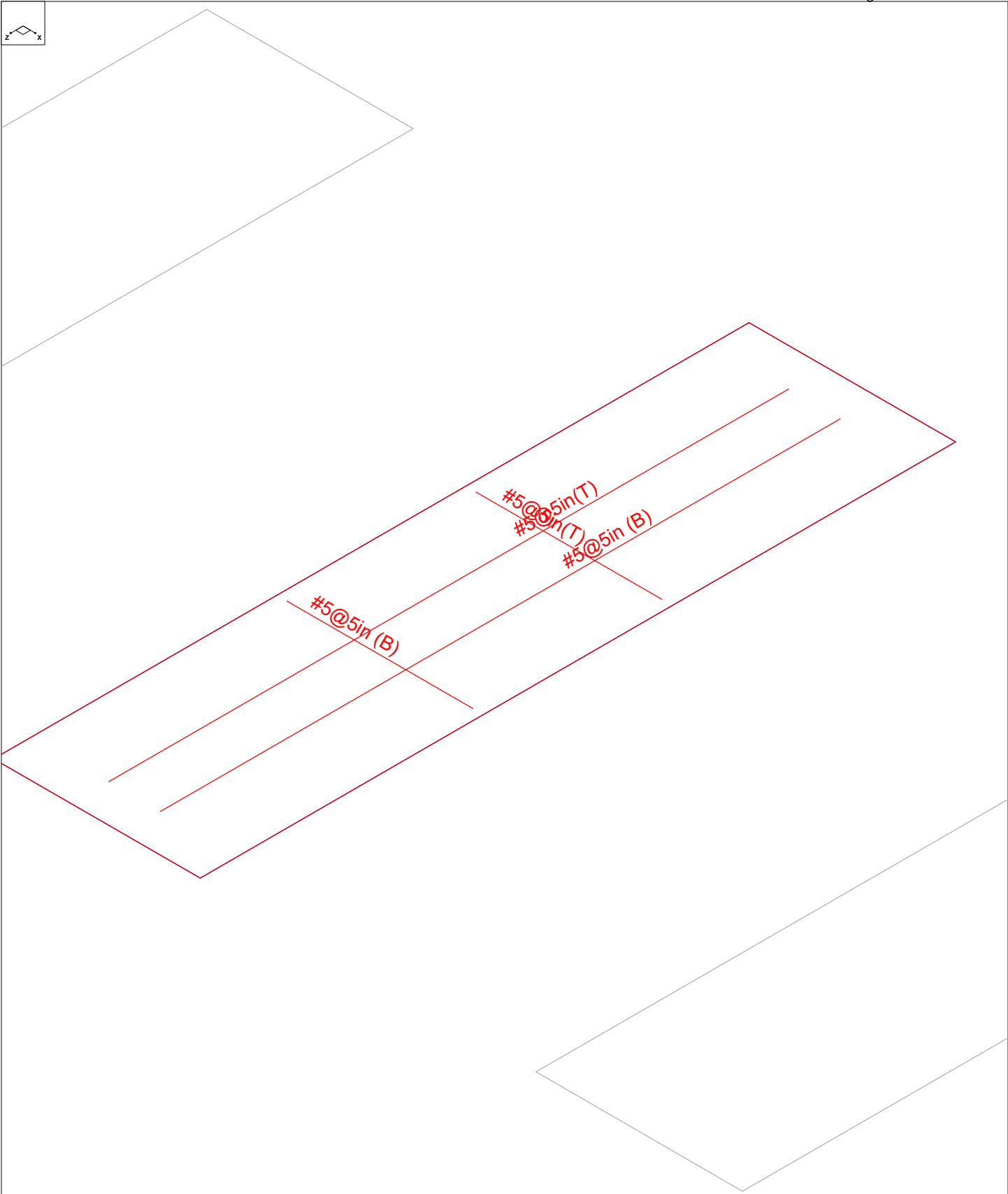

Results for LC 2, 1.0 D

Vector Structural Engineeri..	Ground Mount	SK - 1
STB		Mar 30, 2021 at 3:44 PM
U2716.0281.211		Sunmodo Sunturf A10 (85x45).r3d



(Global) Model Settings

Display Sections for Member Calcs	5
Max Internal Sections for Member Calcs	100
Mesh Size (in)	12
Max Iterations	10
Merge Tolerance (in)	.12
Solver	Sparse Accelerated
Coefficient of Friction	.3
No. of Shear Regions	4
Shear Region Spacing Increment (in)	4
Min 1 Bar Dia Spacing for Beams?	No
Optimize footings for OTM / Sliding?	Yes
Parme Beta Factor	.65
Pile Safety Factor	3
Concrete Stress Block	0
Concrete Rebar Set	Rectangular
Concrete Code	ASTM A615
HR Steel Pile Code	ACI 318-14
Wood Pile Code	AISC 14th (360-10): ASD AWC NDS-15: ASD

Concrete Properties

	Label	E [ksi]	G [ksi]	Nu	Therm (/...	Density[k/ft^3]	fc[psi]	Lambda	Flex Stee...	Shear St...
1	Conc3000NW	3156	1372	.15	.6	.145	3000	1	60000	60000
2	Conc3500NW	3409	1482	.15	.6	.145	3500	1	60000	60000
3	Conc4000NW	3644	1584	.15	.6	.145	4000	1	60000	60000
4	Conc3000LW	2085	907	.15	.6	.11	3000	.75	60000	60000
5	Conc3500LW	2252	979	.15	.6	.11	3500	.75	60000	60000
6	Conc4000LW	2408	1047	.15	.6	.11	4000	.75	60000	60000
7	Conc2500NW	3156	1372	.15	.6	.145	2500	1	60000	60000

General Design Parameters

	Label	Max Bending Chk	Max Shear Chk	Top Cover[in]	Bottom Cover[in]
1	Typical	1	1	3	3

Slab Rebar Parameters

	Label	Top Bar	Bottom Bar	Max Top Bar Sp...	Min Top Bar Sp...	Max Bot Bar Sp...	Min Bot Bar Sp...	Spacing Incr...	Rebar Options
1	Typical	#5	#5	18	5	18	5	1	Optimize

Soil Definitions

	Label	Subgrade Modulus[k/ft^3]	Allowable Bearing[psf]	Depth Properties	Default?
1	Default	172.8	1500	None	Yes

Point Loads and Moments (Cat 1 : DL)

	Label	Direction	Magnitude[lb,lb-ft]
1	R3D_N1	X	-1.078
2	R3D_N1	Y	135.196
3	R3D_N2	X	-7.441
4	R3D_N2	Y	113.481
5	R3D_N123	X	1.127
6	R3D_N123	Y	135.343
7	R3D_N124	X	7.43
8	R3D_N124	Y	113.37

Point Loads and Moments (Cat 1 : DL) (Continued)

	Label	Direction	Magnitude[lb,lb-ft]
9	R3D_N123A_1	Y	266.173
10	R3D_N123A_1	Z	-1.182
11	R3D_N124A_1	X	2.15
12	R3D_N124A_1	Y	233.474
13	R3D_N129_1	Y	225.04
14	R3D_N130_1	Y	215.653
15	R3D_N135_1	Y	231.753
16	R3D_N136_1	Y	218.141
17	R3D_N141_1	Y	229.952
18	R3D_N142_1	Y	217.671
19	R3D_N147B_1	Y	231.758
20	R3D_N148A_1	Y	218.139
21	R3D_N153A_1	Y	225.018
22	R3D_N154A_1	Y	215.66
23	R3D_N161	Y	266.138
24	R3D_N161	Z	-1.184
25	R3D_N162	X	-2.155
26	R3D_N162	Y	233.429

Point Loads and Moments (Cat 6 : RLL)

	Label	Direction	Magnitude[lb,lb-ft]
1	R3D_N1	X	-3.686
2	R3D_N1	Y	365.436
3	R3D_N1	Z	2.85
4	R3D_N2	X	-29.975
5	R3D_N2	Y	387.613
6	R3D_N123	X	3.866
7	R3D_N123	Y	366.074
8	R3D_N123	Z	2.825
9	R3D_N124	X	29.924
10	R3D_N124	Y	387.06
11	R3D_N123A_1	X	3.051
12	R3D_N123A_1	Y	927.812
13	R3D_N123A_1	Z	-4.865
14	R3D_N124A_1	X	8.887
15	R3D_N124A_1	Y	897.914
16	R3D_N129_1	Y	805.225
17	R3D_N129_1	Z	2.373
18	R3D_N130_1	Y	819.988
19	R3D_N135_1	Y	828.275
20	R3D_N136_1	Y	830.582
21	R3D_N141_1	Y	822.015
22	R3D_N142_1	Y	828.57
23	R3D_N147B_1	Y	828.29
24	R3D_N148A_1	Y	830.573
25	R3D_N153A_1	Y	805.173
26	R3D_N153A_1	Z	2.376
27	R3D_N154A_1	Y	820.02
28	R3D_N161	X	-3.075
29	R3D_N161	Y	927.91
30	R3D_N161	Z	-4.873
31	R3D_N162	X	-8.896
32	R3D_N162	Y	897.684

Point Loads and Moments (Cat 16 : OL1)

	Label	Direction	Magnitude[lb,lb-ft]
--	-------	-----------	---------------------



Point Loads and Moments (Cat 16 : OL1) (Continued)

	Label	Direction	Magnitude[lb,lb-ft]
1	R3D N1	Y	-1731.904
2	R3D N1	Z	1067.646
3	R3D N2	X	38.126
4	R3D N2	Y	289.774
5	R3D N2	Z	-71.792
6	R3D N123	Y	-1745.892
7	R3D N123	Z	1067.417
8	R3D N124	X	-37.195
9	R3D N124	Y	304.069
10	R3D N124	Z	-71.784
11	R3D N123A 1	X	-5.562
12	R3D N123A 1	Y	-4480.033
13	R3D N123A 1	Z	2686.226
14	R3D N124A 1	X	-24.055
15	R3D N124A 1	Y	840.78
16	R3D N124A 1	Z	-109.265
17	R3D N129 1	X	1.123
18	R3D N129 1	Y	-3887.832
19	R3D N129 1	Z	2332.594
20	R3D N130 1	Y	695.927
21	R3D N130 1	Z	-112.989
22	R3D N135 1	Y	-3996.911
23	R3D N135 1	Z	2404.294
24	R3D N136 1	X	-2.773
25	R3D N136 1	Y	729.379
26	R3D N136 1	Z	-114.802
27	R3D N141 1	Y	-3970.357
28	R3D N141 1	Z	2387.675
29	R3D N142 1	Y	722.011
30	R3D N142 1	Z	-114.945
31	R3D N147B 1	Y	-3997.168
32	R3D N147B 1	Z	2404.271
33	R3D N148A 1	X	2.675
34	R3D N148A 1	Y	729.559
35	R3D N148A 1	Z	-114.803
36	R3D N153A 1	X	-1.122
37	R3D N153A 1	Y	-3886.582
38	R3D N153A 1	Z	2332.646
39	R3D N154A 1	Y	694.938
40	R3D N154A 1	Z	-112.992
41	R3D N161	X	5.747
42	R3D N161	Y	-4489.344
43	R3D N161	Z	2686.508
44	R3D N162	X	23.555
45	R3D N162	Y	849.641
46	R3D N162	Z	-109.273

Point Loads and Moments (Cat 17 : OL2)

	Label	Direction	Magnitude[lb,lb-ft]
1	R3D N1	Y	-1912.6
2	R3D N1	Z	887.832
3	R3D N2	X	-5.557
4	R3D N2	Y	740.67
5	R3D N2	Z	-59.776
6	R3D N123	Y	-1917
7	R3D N123	Z	887.584



Point Loads and Moments (Cat 17 : OL2) (Continued)

	Label	Direction	Magnitude[lb.lb-ft]
8	R3D_N124	X	5.897
9	R3D_N124	Y	745.042
10	R3D_N124	Z	-59.769
11	R3D_N123A_1	X	-7.455
12	R3D_N123A_1	Y	-4939.306
13	R3D_N123A_1	Z	2238.27
14	R3D_N124A_1	X	-12.836
15	R3D_N124A_1	Y	1874.568
16	R3D_N124A_1	Z	-91.036
17	R3D_N129_1	X	1.538
18	R3D_N129_1	Y	-4275.104
19	R3D_N129_1	Z	1943.858
20	R3D_N130_1	X	-1.44
21	R3D_N130_1	Y	1622.301
22	R3D_N130_1	Z	-94.104
23	R3D_N135_1	Y	-4393.515
24	R3D_N135_1	Z	2001.647
25	R3D_N136_1	X	-2.007
26	R3D_N136_1	Y	1670.423
27	R3D_N136_1	Z	-95.61
28	R3D_N141_1	Y	-4364.981
29	R3D_N141_1	Z	1989.131
30	R3D_N142_1	Y	1660.176
31	R3D_N142_1	Z	-95.733
32	R3D_N147B_1	Y	-4393.628
33	R3D_N147B_1	Z	2001.648
34	R3D_N148A_1	X	2.041
35	R3D_N148A_1	Y	1670.481
36	R3D_N148A_1	Z	-95.611
37	R3D_N153A_1	X	-1.493
38	R3D_N153A_1	Y	-4274.66
39	R3D_N153A_1	Z	1943.883
40	R3D_N154A_1	X	1.503
41	R3D_N154A_1	Y	1622.01
42	R3D_N154A_1	Z	-94.106
43	R3D_N161	X	7.568
44	R3D_N161	Y	-4942.182
45	R3D_N161	Z	2238.596
46	R3D_N162	X	12.754
47	R3D_N162	Y	1877.52
48	R3D_N162	Z	-91.044

Point Loads and Moments (Cat 18 : OL3)

	Label	Direction	Magnitude[lb.lb-ft]
1	R3D_N1	Y	2019.011
2	R3D_N1	Z	-1244.635
3	R3D_N2	X	-44.446
4	R3D_N2	Y	-337.812
5	R3D_N2	Z	83.694
6	R3D_N123	Y	2035.318
7	R3D_N123	Z	-1244.368
8	R3D_N124	X	43.361
9	R3D_N124	Y	-354.476
10	R3D_N124	Z	83.684
11	R3D_N123A_1	X	6.484
12	R3D_N123A_1	Y	5222.712



Point Loads and Moments (Cat 18 : OL3) (Continued)

	Label	Direction	Magnitude[lb,lb-ft]
13	R3D_N123A_1	Z	-3131.536
14	R3D_N124A_1	X	28.042
15	R3D_N124A_1	Y	-980.161
16	R3D_N124A_1	Z	127.378
17	R3D_N129_1	X	-1.309
18	R3D_N129_1	Y	4532.339
19	R3D_N129_1	Z	-2719.281
20	R3D_N130_1	Y	-811.295
21	R3D_N130_1	Z	131.72
22	R3D_N135_1	Y	4659.5
23	R3D_N135_1	Z	-2802.867
24	R3D_N136_1	X	3.232
25	R3D_N136_1	Y	-850.293
26	R3D_N136_1	Z	133.833
27	R3D_N141_1	Y	4628.545
28	R3D_N141_1	Z	-2783.492
29	R3D_N142_1	Y	-841.703
30	R3D_N142_1	Z	134
31	R3D_N147B_1	Y	4659.8
32	R3D_N147B_1	Z	-2802.84
33	R3D_N148A_1	X	-3.118
34	R3D_N148A_1	Y	-850.502
35	R3D_N148A_1	Z	133.834
36	R3D_N153A_1	X	1.308
37	R3D_N153A_1	Y	4530.881
38	R3D_N153A_1	Z	-2719.342
39	R3D_N154A_1	Y	-810.142
40	R3D_N154A_1	Z	131.723
41	R3D_N161	X	-6.7
42	R3D_N161	Y	5233.567
43	R3D_N161	Z	-3131.865
44	R3D_N162	X	-27.46
45	R3D_N162	Y	-990.491
46	R3D_N162	Z	127.387

Point Loads and Moments (Cat 19 : OL4)

	Label	Direction	Magnitude[lb,lb-ft]
1	R3D_N1	Y	1407.13
2	R3D_N1	Z	-1127.414
3	R3D_N2	X	-73.527
4	R3D_N2	Y	140.116
5	R3D_N2	Z	75.744
6	R3D_N123	Y	1428.359
7	R3D_N123	Z	-1127.223
8	R3D_N124	X	72.155
9	R3D_N124	Y	118.313
10	R3D_N124	Z	75.736
11	R3D_N123A_1	X	3.347
12	R3D_N123A_1	Y	3647.192
13	R3D_N123A_1	Z	-2832.622
14	R3D_N124A_1	X	31.8
15	R3D_N124A_1	Y	161.498
16	R3D_N124A_1	Z	115.226
17	R3D_N129_1	Y	3175.163
18	R3D_N129_1	Z	-2459.496
19	R3D_N130_1	X	-1.257



Point Loads and Moments (Cat 19 : OL4) (Continued)

	Label	Direction	Magnitude [lb, lb-ft]
20	R3D N130 1	Y	196.784
21	R3D N130 1	Z	119.186
22	R3D N135 1	Y	3265.615
23	R3D N135 1	Z	-2536.848
24	R3D N136 1	X	3.195
25	R3D N136 1	Y	179.586
26	R3D N136 1	Z	121.101
27	R3D N141 1	Y	3243.336
28	R3D N141 1	Z	-2518.134
29	R3D N142 1	Y	183.688
30	R3D N142 1	Z	121.249
31	R3D N147B 1	Y	3265.976
32	R3D N147B 1	Z	-2536.806
33	R3D N148A 1	X	-2.988
34	R3D N148A 1	Y	179.315
35	R3D N148A 1	Z	121.101
36	R3D N153A 1	Y	3173.31
37	R3D N153A 1	Z	-2459.567
38	R3D N154A 1	X	1.308
39	R3D N154A 1	Y	198.303
40	R3D N154A 1	Z	119.188
41	R3D N161	X	-3.579
42	R3D N161	Y	3661.369
43	R3D N161	Z	-2832.839
44	R3D N162	X	-30.974
45	R3D N162	Y	148.197
46	R3D N162	Z	115.234

Slabs

	Label	Thickness [in]	Material	Local Axis Angle ...	Analysis Offset [in]	Passive Pressur...	Soil Overburden [psf]
1	S1	32	Conc2500NW	0	0	0	0
2	S2	32	Conc2500NW	0	0	0	0
3	S3	32	Conc2500NW	0	0	0	0
4	S4	32	Conc2500NW	0	0	0	0
5	S5	32	Conc2500NW	0	0	0	0
6	S6	32	Conc2500NW	0	0	0	0
7	S7	32	Conc2500NW	0	0	0	0
8	S8	32	Conc2500NW	0	0	0	0
9	S9	32	Conc2500NW	0	0	0	0

Load Combinations

	Label	Solve	Service A...	SF	Cat...	Fa...	Cat...	Fa...	Cat...	Fa...	Cat...	Fa...	Cat...	Fa...	Cat...	Fa...	Cat...	Fa...
1	ASD Loads																	
2	1.0 D	Yes	Yes	1.5	DL	1												
3	1.0 D + 1....	Yes	Yes	1.5	DL	1	RLL	1										
4	1.0 D + 0....	Yes	Yes	1.5	DL	1	RLL		OL1	.6								
5	1.0 D + 0....	Yes	Yes	1.5	DL	1	RLL		OL2	.6								
6	1.0 D + 0....	Yes	Yes	1.5	DL	1	RLL		OL3	.6								
7	1.0 D + 0....	Yes	Yes	1.5	DL	1	RLL		OL4	.6								
8	1.0 D + 0....	Yes	Yes	1.5	DL	1	RLL	.75	OL1	.45								
9	1.0 D + 0....	Yes	Yes	1.5	DL	1	RLL	.75	OL2	.45								
10	1.0 D + 0....	Yes	Yes	1.5	DL	1	RLL	.75	OL3	.45								
11	1.0 D + 0....	Yes	Yes	1.5	DL	1	RLL	.75	OL4	.45								
12	0.9 D + 0....	Yes	Yes		DL	.9	RLL		OL1	.6								
13	0.9 D + 0....	Yes	Yes		DL	.9	RLL		OL2	.6								
14	0.9 D + 0....	Yes	Yes		DL	.9	RLL		OL3	.6								



Load Combinations (Continued)

Label	Solve	Service	A...	SF	Cat..	Fa...	Cat..	Fa...	Cat..	Fa...	Cat..	Fa...	Cat..	Fa...	Cat..	Fa...	Cat..	Fa...	Cat..	Fa...
15	0.9 D + 0...	Yes	Yes		DL	.9	RLL		OL4	.6										
16																				
17	LRFD Loa...																			
18	1.4 D	Yes			DL	1.4	RLL													
19	1.2 D + 1....	Yes			DL	1.2	RLL	1.6	OL1	.5										
20	1.2 D + 1....	Yes			DL	1.2	RLL	1.6	OL2	.5										
21	1.2 D + 1....	Yes			DL	1.2	RLL	1.6	OL3	.5										
22	1.2 D + 1....	Yes			DL	1.2	RLL	1.6	OL4	.5										
23	1.2 D + 1....	Yes			DL	1.2	RLL		OL1	1										
24	1.2 D + 1....	Yes			DL	1.2	RLL		OL2	1										
25	1.2 D + 1....	Yes			DL	1.2	RLL		OL3	1										
26	1.2 D + 1....	Yes			DL	1.2	RLL		OL4	1										
27	1.0 D + 1....	Yes			DL	1	RLL		OL1	1										
28	1.0 D + 1....	Yes			DL	1	RLL		OL2	1										
29	1.0 D + 1....	Yes			DL	1	RLL		OL3	1										
30	1.0 D + 1....	Yes			DL	1	RLL		OL4	1										

Design Strips

Label	Rebar Angle from Pl...	No. of Design Cuts	Design Rule	
1	DS1	0	50	Typical
2	DS2	90	50	Typical

Load Categories

Category	Point Loads	Line Loads	Area Loads
1	DL	26	
2	RLL	32	
3	OL1	46	
4	OL2	48	
5	OL3	46	
6	OL4	46	

Strip Reinforcing

Label	UC Top	LC	Top Bars	Governing ...	UC Bot	LC	Bot B...	Gover...	UC Shear	LC	Governing De...	
1	DS1	.009	21	#5@5in	DS1-X25	.009	28	#5@5in	DS1-...	.024	28	DS1-X15
2	DS2	0	27	#5@5in	DS2-X1	0	21	#5@5in	DS2-...	.005	21	DS2-X7

Slab Overturning Safety Factors (By Combination)

LC	Slab	Angle[deg]	Mo-xx[lb-ft]	Ms-xx[lb-ft]	Mo-zz[lb-ft]	Ms-zz[lb-ft]	Ms-xx/Mo-xx	Ms-zz/Mo-zz
1	2	S1	0	50145.56	0	13758.753	9.999+	9.999+
2	2	S2	0	51326.987	0	14064.931	9.999+	9.999+
3	2	S3	0	51125.296	0	13992.057	9.999+	9.999+
4	2	S4	0	51155.19	0	14004.326	9.999+	9.999+
5	2	S5	0	51148.829	0	14001.297	9.999+	9.999+
6	2	S6	0	51155.18	0	14004.33	9.999+	9.999+
7	2	S7	0	51125.326	0	13992.038	9.999+	9.999+
8	2	S8	0	51326.558	0	14076.304	9.999+	9.999+
9	2	S9	0	50144.818	0	13713.267	9.999+	9.999+
10	3	S1	0	53902.816	0	14852.582	9.999+	9.999+
11	3	S2	0	60108.531	0	16467.398	9.999+	9.999+
12	3	S3	0	59106.814	0	16159.007	9.999+	9.999+
13	3	S4	0	59250.286	0	16216.136	9.999+	9.999+
14	3	S5	0	59218.64	0	16202.078	9.999+	9.999+
15	3	S6	0	59250.22	0	16216.148	9.999+	9.999+
16	3	S7	0	59107.057	0	16158.962	9.999+	9.999+
17	3	S8	0	60106.272	0	16542.351	9.999+	9.999+



Slab Overturning Safety Factors (By Combination) (Continued)

	LC	Slab	Angle[deg]	Mo-xx[lb-ft]	Ms-xx[lb-ft]	Mo-zz[lb-ft]	Ms-zz[lb-ft]	Ms-xx/Mo-xx	Ms-zz/Mo-zz
18	3	S9	0	0	53898.2	0	14627.338	9.999+	9.999+
19	4	S1	0	10107.677	50299.377	1214.705	13758.753	4.976	9.999+
20	4	S2	0	26074.725	51564.92	2958.789	14076.397	1.978	4.757
21	4	S3	0	22628.218	51191.797	2555.32	13992.057	2.262	5.476
22	4	S4	0	23264.125	51251.616	2618.461	14004.326	2.203	5.348
23	4	S5	0	23109.101	51235.832	2598.677	14001.297	2.217	5.388
24	4	S6	0	23265.239	51251.659	2618.366	14004.33	2.203	5.348
25	4	S7	0	22622.774	51191.626	2555.11	13992.038	2.263	5.476
26	4	S8	0	26115.097	51564.572	2958.645	14076.304	1.975	4.758
27	4	S9	0	10166.531	50300.471	1212.971	13758.902	4.948	9.999+
28	5	S1	0	10390.999	50299.377	946.436	13713.32	4.841	9.999+
29	5	S2	0	26879.452	51564.92	2484.256	14076.397	1.918	5.666
30	5	S3	0	23251.073	51191.797	2122.398	13992.057	2.202	6.593
31	5	S4	0	23900.606	51251.616	2181.685	14004.326	2.144	6.419
32	5	S5	0	23744.482	51235.832	2163.844	14001.297	2.158	6.471
33	5	S6	0	23901.128	51251.659	2181.783	14004.33	2.144	6.419
34	5	S7	0	23249.101	51191.626	2122.137	13992.038	2.202	6.593
35	5	S8	0	26892.127	51564.572	2484.246	14076.304	1.917	5.666
36	5	S9	0	10409.335	50300.471	947.002	13713.267	4.832	9.999+
37	6	S1	0	1948.251	50145.56	0	15174.826	9.999+	9.999+
38	6	S2	0	5578.306	51326.987	0	17403.73	9.201	9.999+
39	6	S3	0	4611.275	51125.296	0	16970.986	9.999+	9.999+
40	6	S4	0	4836.842	51155.19	0	17046.52	9.999+	9.999+
41	6	S5	0	4786.961	51148.829	0	17030.77	9.999+	9.999+
42	6	S6	0	4837.612	51155.18	0	17056.757	9.999+	9.999+
43	6	S7	0	4606.71	51125.326	0	16966.537	9.999+	9.999+
44	6	S8	0	5622.3	51326.558	0	17525.42	9.129	9.999+
45	6	S9	0	2018.946	50144.818	0	14988.563	9.999+	9.999+
46	7	S1	0	0	50296.176	0	15114.192	9.999+	9.999+
47	7	S2	0	614.526	51326.987	0	17055.648	9.999+	9.999+
48	7	S3	0	210.617	51125.296	0	16691.626	9.999+	9.999+
49	7	S4	0	345.806	51155.19	0	16755.375	9.999+	9.999+
50	7	S5	0	312.731	51148.829	0	16742.916	9.999+	9.999+
51	7	S6	0	346.813	51155.18	0	16765.344	9.999+	9.999+
52	7	S7	0	204.538	51125.326	0	16687.236	9.999+	9.999+
53	7	S8	0	670.687	51326.558	0	17179.241	9.999+	9.999+
54	7	S9	0	0	50202.602	0	14835.155	9.999+	9.999+
55	8	S1	0	7580.758	52988.116	911.029	14579.124	6.99	9.999+
56	8	S2	0	19556.043	58329.405	2219.091	15925.999	2.983	7.177
57	8	S3	0	16971.163	57090.045	1916.49	15617.27	3.364	8.149
58	8	S4	0	17448.094	57310.71	1963.846	15663.183	3.285	7.976
59	8	S5	0	17331.826	57253.399	1949.007	15651.882	3.303	8.031
60	8	S6	0	17448.93	57310.837	1963.775	15663.193	3.284	7.976
61	8	S7	0	16967.081	57089.573	1916.332	15617.231	3.365	8.15
62	8	S8	0	19586.323	58329.46	2218.984	15925.839	2.978	7.177
63	8	S9	0	7624.898	52992.736	909.728	14579.616	6.95	9.999+
64	9	S1	0	7793.249	52988.116	709.827	14399.046	6.799	9.999+
65	9	S2	0	20159.589	58329.405	1863.192	15925.999	2.893	8.548
66	9	S3	0	17438.305	57090.045	1591.799	15617.27	3.274	9.811
67	9	S4	0	17925.455	57310.71	1636.263	15663.183	3.197	9.573
68	9	S5	0	17808.362	57253.399	1622.883	15651.882	3.215	9.644
69	9	S6	0	17925.846	57310.837	1636.337	15663.193	3.197	9.572
70	9	S7	0	17436.826	57089.573	1591.603	15617.231	3.274	9.812
71	9	S8	0	20169.095	58329.46	1863.185	15925.839	2.892	8.548
72	9	S9	0	7807.001	52992.736	710.252	14398.82	6.788	9.999+
73	10	S1	0	1461.188	52963.502	0	15641.179	9.999+	9.999+
74	10	S2	0	4183.729	57913.145	0	18370.881	9.999+	9.999+



Slab Overturning Safety Factors (By Combination) (Continued)

LC	Slab	Angle[deg]	Mo-xx[lb-ft]	Ms-xx[lb-ft]	Mo-zz[lb-ft]	Ms-zz[lb-ft]	Ms-xx/Mo-xx	Ms-zz/Mo-zz	
75	10	S3	0	3458.456	57111.435	0	17851.467	9.999+	9.999+
76	10	S4	0	3627.631	57226.512	0	17944.829	9.999+	9.999+
77	10	S5	0	3590.221	57201.187	0	17923.987	9.999+	9.999+
78	10	S6	0	3628.209	57226.46	0	17952.514	9.999+	9.999+
79	10	S7	0	3455.032	57111.625	0	17848.106	9.999+	9.999+
80	10	S8	0	4216.725	57911.344	0	18512.676	9.999+	9.999+
81	10	S9	0	1514.209	52959.854	0	15355.293	9.999+	9.999+
82	11	S1	0	0	53076.464	0	15595.704	9.999+	9.999+
83	11	S2	0	460.894	57913.145	0	18109.819	9.999+	9.999+
84	11	S3	0	157.963	57111.435	0	17641.946	9.999+	9.999+
85	11	S4	0	259.355	57226.512	0	17726.47	9.999+	9.999+
86	11	S5	0	234.548	57201.187	0	17708.097	9.999+	9.999+
87	11	S6	0	260.11	57226.46	0	17733.954	9.999+	9.999+
88	11	S7	0	153.403	57111.625	0	17638.63	9.999+	9.999+
89	11	S8	0	503.015	57911.344	0	18253.042	9.999+	9.999+
90	11	S9	0	0	53003.192	0	15240.237	9.999+	9.999+
91	12	S1	0	10107.677	45269.439	1214.705	12382.877	4.479	9.999+
92	12	S2	0	26074.725	46408.428	2958.789	12668.758	1.78	4.282
93	12	S3	0	22628.218	46072.617	2555.32	12592.851	2.036	4.928
94	12	S4	0	23264.125	46126.454	2618.461	12603.893	1.983	4.813
95	12	S5	0	23109.101	46112.248	2598.677	12601.167	1.995	4.849
96	12	S6	0	23265.239	46126.493	2618.366	12603.897	1.983	4.814
97	12	S7	0	22622.774	46072.463	2555.11	12592.834	2.037	4.928
98	12	S8	0	26115.097	46408.114	2958.645	12668.673	1.777	4.282
99	12	S9	0	10166.531	45270.424	1212.971	12383.012	4.453	9.999+
100	13	S1	0	10390.999	45269.439	946.436	12341.988	4.357	9.999+
101	13	S2	0	26879.452	46408.428	2484.256	12668.758	1.727	5.1
102	13	S3	0	23251.073	46072.617	2122.398	12592.851	1.982	5.933
103	13	S4	0	23900.606	46126.454	2181.685	12603.893	1.93	5.777
104	13	S5	0	23744.482	46112.248	2163.844	12601.167	1.942	5.824
105	13	S6	0	23901.128	46126.493	2181.783	12603.897	1.93	5.777
106	13	S7	0	23249.101	46072.463	2122.137	12592.834	1.982	5.934
107	13	S8	0	26892.127	46408.114	2484.246	12668.673	1.726	5.1
108	13	S9	0	10409.335	45270.424	947.002	12341.94	4.349	9.999+
109	14	S1	0	1948.251	45131.004	0	13798.951	9.999+	9.999+
110	14	S2	0	5578.306	46194.288	0	15997.237	8.281	9.999+
111	14	S3	0	4611.275	46012.767	0	15571.781	9.978	9.999+
112	14	S4	0	4836.842	46039.671	0	15646.088	9.519	9.999+
113	14	S5	0	4786.961	46033.946	0	15630.641	9.617	9.999+
114	14	S6	0	4837.612	46039.662	0	15656.324	9.517	9.999+
115	14	S7	0	4606.71	46012.793	0	15567.334	9.988	9.999+
116	14	S8	0	5622.3	46193.902	0	16117.789	8.216	9.999+
117	14	S9	0	2018.946	45130.336	0	13617.237	9.999+	9.999+
118	15	S1	0	0	45281.62	0	13738.317	9.999+	9.999+
119	15	S2	0	614.526	46194.288	0	15649.155	9.999+	9.999+
120	15	S3	0	210.617	46012.767	0	15292.42	9.999+	9.999+
121	15	S4	0	345.806	46039.671	0	15354.942	9.999+	9.999+
122	15	S5	0	312.731	46033.946	0	15342.786	9.999+	9.999+
123	15	S6	0	346.813	46039.662	0	15364.911	9.999+	9.999+
124	15	S7	0	204.538	46012.793	0	15288.033	9.999+	9.999+
125	15	S8	0	670.687	46193.902	0	15771.611	9.999+	9.999+
126	15	S9	0	0	45188.12	0	13463.829	9.999+	9.999+



Slab Sliding Safety Factors (By Combination)

	LC	Slab	Angle[deg]	Va-xx[lb]	Vr-xx[lb]	Va-zz[lb]	Vr-zz[lb]	SR-xx	SR-zz
1	2	S1	0	8.519	3090.608	0	3090.608	9.999+	9.999+
2	2	S2	0	2.15	3165.899	1.182	3165.899	9.999+	9.999+
3	2	S3	0	0	3148.213	0	3148.213	9.999+	9.999+
4	2	S4	0	0	3150.973	0	3150.973	9.999+	9.999+
5	2	S5	0	0	3150.292	0	3150.292	9.999+	9.999+
6	2	S6	0	0	3150.974	0	3150.974	9.999+	9.999+
7	2	S7	0	0	3148.209	0	3148.209	9.999+	9.999+
8	2	S8	0	2.155	3165.876	1.184	3165.876	9.999+	9.999+
9	2	S9	0	8.557	3090.619	0	3090.619	9.999+	9.999+
10	3	S1	0	42.18	3316.523	2.85	3316.523	9.999+	9.999+
11	3	S2	0	14.088	3713.617	6.047	3713.617	9.999+	9.999+
12	3	S3	0	0	3635.777	2.373	3635.777	9.999+	9.999+
13	3	S4	0	0	3648.631	0	3648.631	9.999+	9.999+
14	3	S5	0	0	3645.467	0	3645.467	9.999+	9.999+
15	3	S6	0	0	3648.633	0	3648.633	9.999+	9.999+
16	3	S7	0	0	3635.766	2.376	3635.766	9.999+	9.999+
17	3	S8	0	14.126	3713.554	6.057	3713.554	9.999+	9.999+
18	3	S9	0	42.347	3316.559	2.825	3316.559	9.999+	9.999+
19	4	S1	0	14.357	2831.025	597.512	2831.025	9.999+	4.738
20	4	S2	0	15.62	2510.834	1544.995	2510.834	9.999+	1.625
21	4	S3	0	.674	2573.67	1331.763	2573.67	9.999+	1.933
22	4	S4	0	1.664	2562.818	1373.696	2562.818	9.999+	1.866
23	4	S5	0	0	2565.59	1363.638	2565.59	9.999+	1.881
24	4	S6	0	1.605	2562.805	1373.681	2562.805	9.999+	1.866
25	4	S7	0	.673	2573.713	1331.793	2573.713	9.999+	1.933
26	4	S8	0	15.427	2510.729	1545.158	2510.729	9.999+	1.625
27	4	S9	0	13.76	2831.091	597.379	2831.091	9.999+	4.739
28	5	S1	0	11.853	2879.661	496.833	2879.661	9.999+	5.796
29	5	S2	0	10.025	2614.247	1287.158	2614.247	9.999+	2.031
30	5	S3	0	.059	2670.708	1109.853	2670.708	9.999+	2.406
31	5	S4	0	1.204	2660.817	1143.622	2660.817	9.999+	2.327
32	5	S5	0	0	2663.427	1136.039	2663.427	9.999+	2.344
33	5	S6	0	1.225	2660.808	1143.622	2660.808	9.999+	2.327
34	5	S7	0	.006	2670.731	1109.866	2670.731	9.999+	2.406
35	5	S8	0	10.039	2614.236	1287.347	2614.236	9.999+	2.031
36	5	S9	0	12.095	2879.667	496.689	2879.667	9.999+	5.798
37	6	S1	0	35.186	3393.224	696.565	3393.224	9.999+	4.871
38	6	S2	0	22.866	3929.559	1803.677	3929.559	9.999+	2.179
39	6	S3	0	.785	3818.001	1552.537	3818.001	9.999+	2.459
40	6	S4	0	1.939	3836.631	1601.42	3836.631	9.999+	2.396
41	6	S5	0	0	3831.923	1589.695	3831.923	9.999+	2.41
42	6	S6	0	1.871	3836.648	1601.403	3836.648	9.999+	2.396
43	6	S7	0	.785	3817.942	1552.571	3817.942	9.999+	2.459
44	6	S8	0	22.65	3929.629	1803.871	3929.629	9.999+	2.178
45	6	S9	0	34.573	3393.171	696.41	3393.171	9.999+	4.872
46	7	S1	0	52.635	3369.112	631.002	3369.112	9.999+	5.339
47	7	S2	0	23.238	3851.464	1631.619	3851.464	9.999+	2.361
48	7	S3	0	.754	3755.163	1404.186	3755.163	9.999+	2.674
49	7	S4	0	1.917	3771.109	1449.449	3771.109	9.999+	2.602
50	7	S5	0	0	3767.156	1438.131	3767.156	9.999+	2.619
51	7	S6	0	1.793	3771.127	1449.422	3771.127	9.999+	2.602
52	7	S7	0	.785	3755.099	1404.227	3755.099	9.999+	2.674
53	7	S8	0	22.886	3851.597	1631.747	3851.597	9.999+	2.36
54	7	S9	0	51.85	3369.02	630.892	3369.02	9.999+	5.34
55	8	S1	0	16.608	3065.357	450.271	3065.357	9.999+	6.808
56	8	S2	0	2.224	3085.389	1154.802	3085.389	9.999+	2.672
57	8	S3	0	.505	3082.979	1000.602	3082.979	9.999+	3.081



Slab Sliding Safety Factors (By Combination) (Continued)

	LC	Slab	Angle[deg]	Va-xx[lb]	Vr-xx[lb]	Va-zz[lb]	Vr-zz[lb]	SR-xx	SR-zz
58	8	S4	0	1.248	3083.099	1030.272	3083.099	9.999+	2.993
59	8	S5	0	0	3083.147	1022.728	3083.147	9.999+	3.015
60	8	S6	0	1.204	3083.091	1030.261	3083.091	9.999+	2.993
61	8	S7	0	.505	3083.005	1000.626	3083.005	9.999+	3.081
62	8	S8	0	2.053	3085.274	1154.917	3085.274	9.999+	2.671
63	8	S9	0	17.162	3065.428	450.154	3065.428	9.999+	6.81
64	9	S1	0	36.265	3101.834	374.762	3101.834	9.999+	8.277
65	9	S2	0	1.972	3162.948	961.425	3162.948	9.999+	3.29
66	9	S3	0	.044	3155.757	834.169	3155.757	9.999+	3.783
67	9	S4	0	.903	3156.599	857.717	3156.599	9.999+	3.68
68	9	S5	0	0	3156.525	852.029	3156.525	9.999+	3.705
69	9	S6	0	.918	3156.594	857.717	3156.594	9.999+	3.68
70	9	S7	0	.005	3155.769	834.182	3155.769	9.999+	3.783
71	9	S8	0	1.988	3162.905	961.56	3162.905	9.999+	3.289
72	9	S9	0	36.553	3101.86	374.636	3101.86	9.999+	8.28
73	10	S1	0	53.765	3487.006	520.286	3487.006	9.999+	6.702
74	10	S2	0	26.64	4149.432	1356.702	4149.432	9.999+	3.058
75	10	S3	0	.589	4016.227	1162.623	4016.227	9.999+	3.454
76	10	S4	0	1.454	4038.459	1201.065	4038.459	9.999+	3.362
77	10	S5	0	0	4032.897	1192.271	4032.897	9.999+	3.383
78	10	S6	0	1.403	4038.474	1201.053	4038.474	9.999+	3.362
79	10	S7	0	.588	4016.177	1162.646	4016.177	9.999+	3.454
80	10	S8	0	26.505	4149.449	1356.854	4149.449	9.999+	3.058
81	10	S9	0	53.412	3486.988	520.189	3486.988	9.999+	6.703
82	11	S1	0	66.852	3468.922	471.114	3468.922	9.999+	7.363
83	11	S2	0	26.919	4090.861	1227.659	4090.861	9.999+	3.332
84	11	S3	0	.566	3969.098	1051.36	3969.098	9.999+	3.775
85	11	S4	0	1.438	3989.318	1087.087	3989.318	9.999+	3.67
86	11	S5	0	0	3984.322	1078.598	3984.322	9.999+	3.694
87	11	S6	0	1.345	3989.333	1087.067	3989.333	9.999+	3.67
88	11	S7	0	.588	3969.045	1051.389	3969.045	9.999+	3.775
89	11	S8	0	26.682	4090.925	1227.761	4090.925	9.999+	3.332
90	11	S9	0	66.369	3468.875	471.05	3468.875	9.999+	7.364
91	12	S1	0	15.209	2521.964	597.512	2521.964	9.999+	4.221
92	12	S2	0	15.835	2194.244	1545.113	2194.244	9.999+	1.42
93	12	S3	0	.674	2258.849	1331.763	2258.849	9.999+	1.696
94	12	S4	0	1.664	2247.72	1373.696	2247.72	9.999+	1.636
95	12	S5	0	0	2250.56	1363.638	2250.56	9.999+	1.65
96	12	S6	0	1.605	2247.707	1373.681	2247.707	9.999+	1.636
97	12	S7	0	.673	2258.892	1331.793	2258.892	9.999+	1.696
98	12	S8	0	15.642	2194.141	1545.276	2194.141	9.999+	1.42
99	12	S9	0	14.616	2522.029	597.379	2522.029	9.999+	4.222
100	13	S1	0	11.001	2570.6	496.833	2570.6	9.999+	5.174
101	13	S2	0	10.24	2297.657	1287.277	2297.657	9.999+	1.785
102	13	S3	0	.059	2355.887	1109.853	2355.887	9.999+	2.123
103	13	S4	0	1.204	2345.719	1143.622	2345.719	9.999+	2.051
104	13	S5	0	0	2348.398	1136.039	2348.398	9.999+	2.067
105	13	S6	0	1.225	2345.71	1143.622	2345.71	9.999+	2.051
106	13	S7	0	.006	2355.911	1109.866	2355.911	9.999+	2.123
107	13	S8	0	10.254	2297.649	1287.466	2297.649	9.999+	1.785
108	13	S9	0	11.239	2570.605	496.689	2570.605	9.999+	5.175
109	14	S1	0	34.335	3084.163	696.565	3084.163	9.999+	4.428
110	14	S2	0	22.651	3612.969	1803.559	3612.969	9.999+	2.003
111	14	S3	0	.785	3503.18	1552.537	3503.18	9.999+	2.256
112	14	S4	0	1.939	3521.533	1601.42	3521.533	9.999+	2.199
113	14	S5	0	0	3516.894	1589.695	3516.894	9.999+	2.212
114	14	S6	0	1.871	3521.551	1601.403	3521.551	9.999+	2.199



Slab Sliding Safety Factors (By Combination) (Continued)

	LC	Slab	Angle[deg]	Va-xx[lb]	Vr-xx[lb]	Va-zz[lb]	Vr-zz[lb]	SR-xx	SR-zz
115	14	S7	0	.785	3503.121	1552.571	3503.121	9.999+	2.256
116	14	S8	0	22.435	3613.042	1803.752	3613.042	9.999+	2.003
117	14	S9	0	33.717	3084.109	696.41	3084.109	9.999+	4.429
118	15	S1	0	51.783	3060.052	631.002	3060.052	9.999+	4.85
119	15	S2	0	23.023	3534.874	1631.501	3534.874	9.999+	2.167
120	15	S3	0	.754	3440.342	1404.186	3440.342	9.999+	2.45
121	15	S4	0	1.917	3456.012	1449.449	3456.012	9.999+	2.384
122	15	S5	0	0	3452.127	1438.131	3452.127	9.999+	2.4
123	15	S6	0	1.793	3456.029	1449.422	3456.029	9.999+	2.384
124	15	S7	0	.785	3440.278	1404.227	3440.278	9.999+	2.45
125	15	S8	0	22.671	3535.01	1631.628	3535.01	9.999+	2.167
126	15	S9	0	50.994	3059.958	630.892	3059.958	9.999+	4.85

Envelope Slab Soil Pressures

	Label	UC	LC	Soil Pressure[psf]	Allowable Bearing[psf]	Point
1	S1	.369	6	553.357	1500	N254
2	S2	.542	6	813.135	1500	N261
3	S3	.503	6	754.452	1500	N268
4	S4	.51	6	765.396	1500	N275
5	S5	.508	6	762.73	1500	N282
6	S6	.51	6	765.424	1500	N289
7	S7	.503	6	754.313	1500	N296
8	S8	.543	6	814.189	1500	N303
9	S9	.37	6	554.997	1500	N310



Company:		Date:	5/14/2018
Engineer:		Page:	1/6
Project:			
Address:			
Phone:			
E-mail:			

1. Project information

Customer company:
 Customer contact name:
 Customer e-mail:
 Comment:

Project description:
 Location:
 Fastening description:

2. Input Data & Anchor Parameters

General

Design method: ACI 318-14
 Units: Imperial units

Anchor Information:

Anchor type: Bonded anchor
 Material: F1554 Grade 36
 Diameter (inch): 0.375
 Effective Embedment depth, h_{ef} (inch): 4.000
 Code report: ICC-ES ESR-4057
 Anchor category: -
 Anchor ductility: Yes
 h_{min} (inch): 5.25
 c_{ac} (inch): 7.12
 C_{min} (inch): 1.75
 S_{min} (inch): 3.00

Base Material

Concrete: Normal-weight
 Concrete thickness, h (inch): 33.00
 State: Cracked
 Compressive strength, f'_c (psi): 2500
 $\Psi_{c,v}$: 1.0
 Reinforcement condition: B tension, B shear
 Supplemental reinforcement: Not applicable
 Reinforcement provided at corners: No
 Ignore concrete breakout in tension: No
 Ignore concrete breakout in shear: No
 Hole condition: Dry concrete
 Inspection: Periodic
 Temperature range, Short/Long: 150/110°F
 Ignore 6do requirement: Not applicable
 Build-up grout pad: No

Base Plate

Length x Width x Thickness (inch): 4.75 x 4.75 x 0.31

Recommended Anchor

Anchor Name: SET-3G - SET-3G w/ 3/8"Ø F1554 Gr. 36
 Code Report: ICC-ES ESR-4057



Company:		Date:	5/14/2018
Engineer:		Page:	2/6
Project:			
Address:			
Phone:			
E-mail:			

Load and Geometry

Load factor source: ACI 318 Section 5.3

Load combination: not set

Seismic design: No

Anchors subjected to sustained tension: No

Apply entire shear load at front row: No

Anchors only resisting wind and/or seismic loads: No

Strength level loads:

N_{ua} [lb]: 4684

V_{uax} [lb]: 77

V_{uay} [lb]: -3134

M_{ux} [ft-lb]: 0

M_{uy} [ft-lb]: 0

M_{uz} [ft-lb]: 0

<Figure 1>

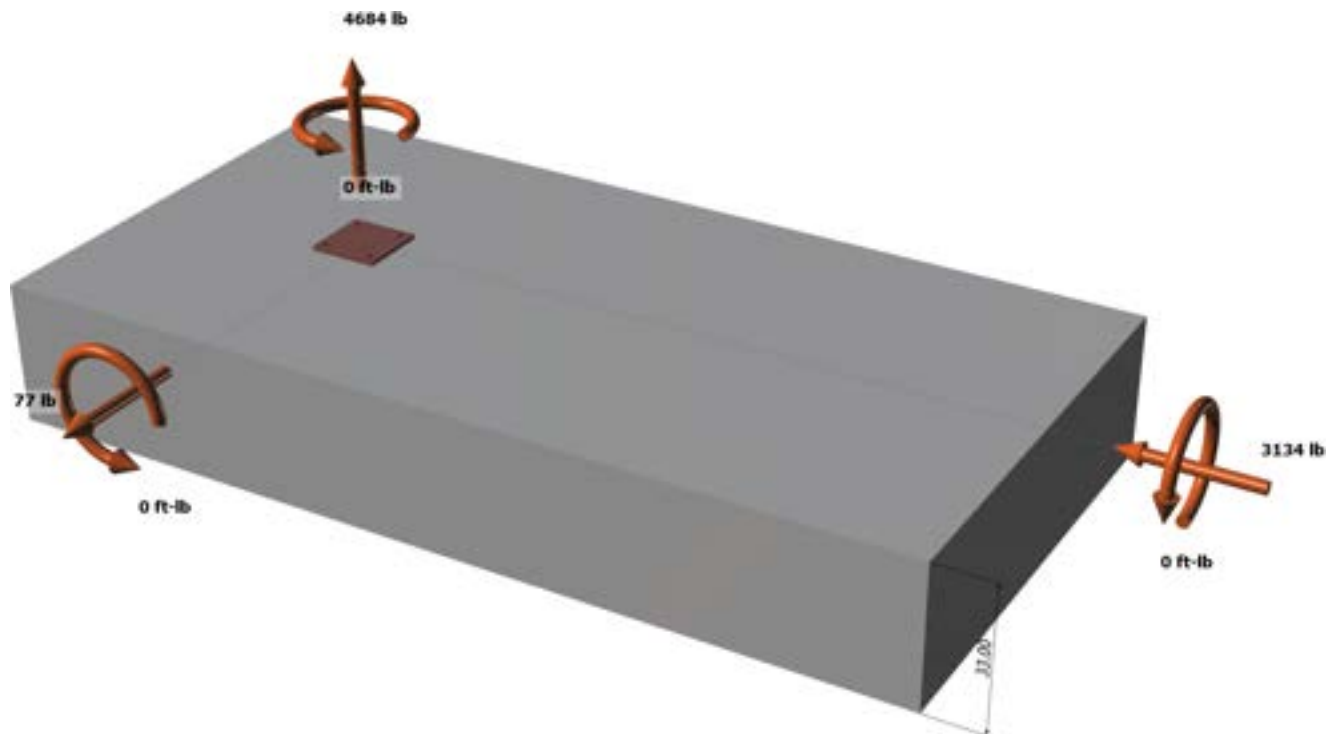

Input data and results must be checked for agreement with the existing circumstances, the standards and guidelines must be checked for plausibility.



Anchor Designer™
 Software
 Version 2.6.6703.0

Company:		Date:	5/14/2018
Engineer:		Page:	3/6
Project:			
Address:			
Phone:			
E-mail:			

<Figure 2>

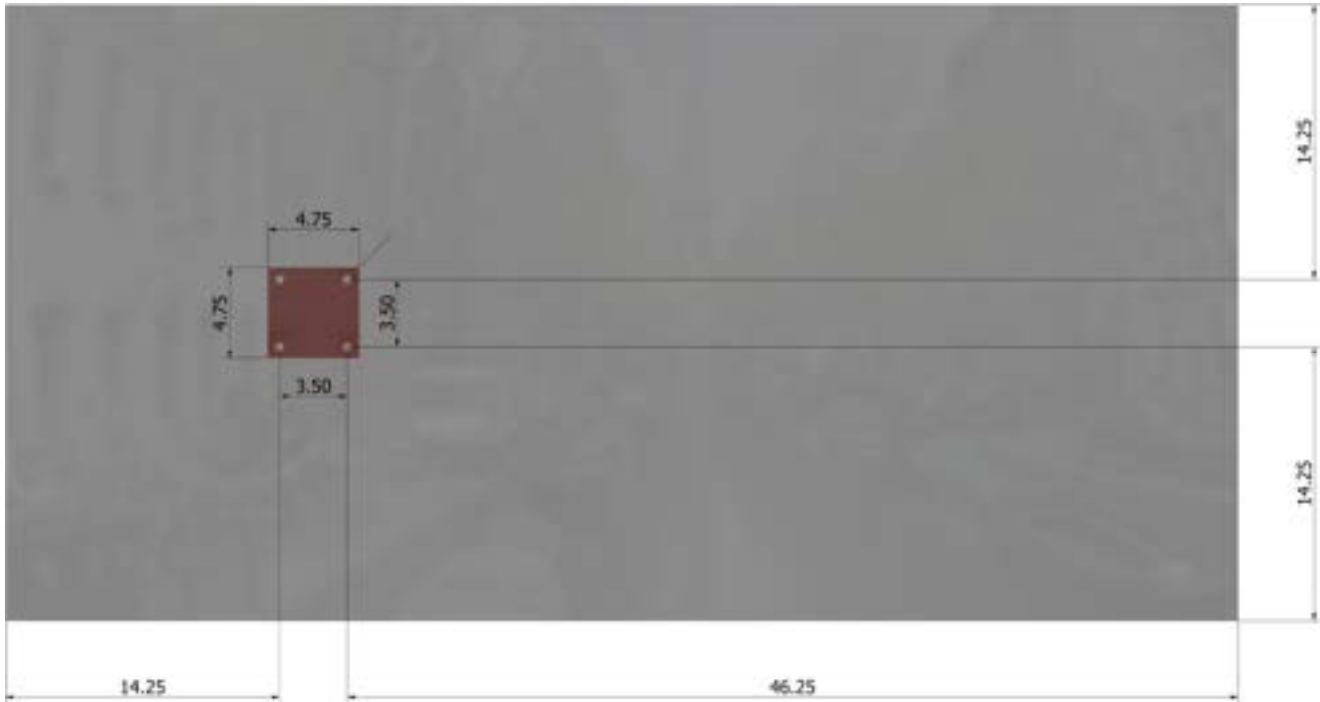

Company:		Date:	5/14/2018
Engineer:		Page:	4/6
Project:			
Address:			
Phone:			
E-mail:			

3. Resulting Anchor Forces

Anchor	Tension load, N _{ua} (lb)	Shear load x, V _{uax} (lb)	Shear load y, V _{uay} (lb)	Shear load combined, $\sqrt{(V_{uax})^2 + (V_{uay})^2}$ (lb)
1	1171.0	19.3	-783.5	783.7
2	1171.0	19.3	-783.5	783.7
3	1171.0	19.3	-783.5	783.7
4	1171.0	19.3	-783.5	783.7
Sum	4684.0	77.0	-3134.0	3134.9

Maximum concrete compression strain (%): 0.00
 Maximum concrete compression stress (psi): 0
 Resultant tension force (lb): 4684
 Resultant compression force (lb): 0
 Eccentricity of resultant tension forces in x-axis, e'_{Nx} (inch): 0.00
 Eccentricity of resultant tension forces in y-axis, e'_{Ny} (inch): 0.00
 Eccentricity of resultant shear forces in x-axis, e'_{Vx} (inch): 0.00
 Eccentricity of resultant shear forces in y-axis, e'_{Vy} (inch): 0.00

<Figure 3>

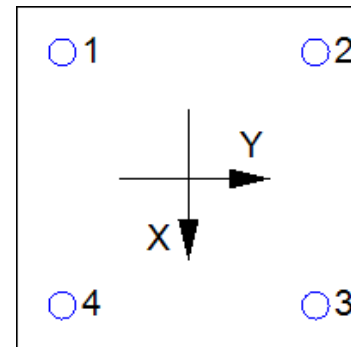

4. Steel Strength of Anchor in Tension (Sec. 17.4.1)

N _{sa} (lb)	ϕ	ϕN_{sa} (lb)
4525	0.75	3394

5. Concrete Breakout Strength of Anchor in Tension (Sec. 17.4.2)

$$N_b = K_c \lambda_a \sqrt{f_c} h_{ef}^{1.5} \text{ (Eq. 17.4.2.2a)}$$

K _c	λ_a	f _c (psi)	h _{ef} (in)	N _b (lb)
17.0	1.00	2500	4.000	6800

$$\phi N_{cbg} = \phi (A_{Nc} / A_{Nco}) \Psi_{ec,N} \Psi_{ed,N} \Psi_{c,N} \Psi_{cp,N} N_b \text{ (Sec. 17.3.1 \& Eq. 17.4.2.1b)}$$

A _{Nc} (in ²)	A _{Nco} (in ²)	C _{a,min} (in)	$\Psi_{ec,N}$	$\Psi_{ed,N}$	$\Psi_{c,N}$	$\Psi_{cp,N}$	N _b (lb)	ϕ	ϕN_{cbg} (lb)
240.25	144.00	14.25	1.000	1.000	1.00	1.000	6800	0.65	7374

6. Adhesive Strength of Anchor in Tension (Sec. 17.4.5)

$$\tau_{k,cr} = \tau_{k,cr,short-term} K_{sat} (f_c / 2,500)^n$$

$\tau_{k,cr}$ (psi)	f _{short-term}	K _{sat}	f _c (psi)	n	$\tau_{k,cr}$ (psi)
1346	1.00	1.00	2500	0.24	1346

$$N_{ba} = \lambda_a \tau_{cr} \pi d_a h_{ef} \text{ (Eq. 17.4.5.2)}$$

λ_a	τ_{cr} (psi)	d _a (in)	h _{ef} (in)	N _{ba} (lb)
1.00	1346	0.38	4.000	6343

$$\phi N_{ag} = \phi (A_{Na} / A_{Na0}) \Psi_{ec,Na} \Psi_{ed,Na} \Psi_{cp,Na} N_{ba} \text{ (Sec. 17.3.1 \& Eq. 17.4.5.1b)}$$

A _{Na} (in ²)	A _{Na0} (in ²)	C _{Na} (in)	C _{a,min} (in)	$\Psi_{ec,Na}$	$\Psi_{ed,Na}$	$\Psi_{cp,Na}$	N _{ba} (lb)	ϕ	ϕN_{ag} (lb)
198.45	112.09	5.29	14.25	1.000	1.000	1.000	6343	0.55	6176

Input data and results must be checked for agreement with the existing circumstances, the standards and guidelines must be checked for plausibility.



Anchor Designer™
Software
Version 2.6.6703.0

Company:		Date:	5/14/2018
Engineer:		Page:	5/6
Project:			
Address:			
Phone:			
E-mail:			

8. Steel Strength of Anchor in Shear (Sec. 17.5.1)

V_{sa} (lb)	ϕ_{grout}	ϕ	$\phi_{grout}\phi V_{sa}$ (lb)
2715	1.0	0.65	1765

9. Concrete Breakout Strength of Anchor in Shear (Sec. 17.5.2)

Shear perpendicular to edge in x-direction:

$$V_{bx} = \min|7(l_e/d_a)^{0.2}\sqrt{d_a}\lambda_a\sqrt{f_c}c_{a1}^{1.5}; 9\lambda_a\sqrt{f_c}c_{a1}^{1.5}| \text{ (Eq. 17.5.2.2a \& Eq. 17.5.2.2b)}$$

l_e (in)	d_a (in)	λ_a	f_c (psi)	c_{a1} (in)	V_{bx} (lb)
3.00	0.375	1.00	2500	17.75	24294

$$\phi V_{cbgx} = \phi (A_{Vc} / A_{Vco}) \Psi_{ec,V} \Psi_{ed,V} \Psi_{c,V} \Psi_{h,V} V_{bx} \text{ (Sec. 17.3.1 \& Eq. 17.5.2.1b)}$$

A_{Vc} (in ²)	A_{Vco} (in ²)	$\Psi_{ec,V}$	$\Psi_{ed,V}$	$\Psi_{c,V}$	$\Psi_{h,V}$	V_{bx} (lb)	ϕ	ϕV_{cbgx} (lb)
1181.48	1417.78	1.000	0.861	1.000	1.000	24294	0.70	12195

Shear perpendicular to edge in y-direction:

$$V_{by} = \min|7(l_e/d_a)^{0.2}\sqrt{d_a}\lambda_a\sqrt{f_c}c_{a1}^{1.5}; 9\lambda_a\sqrt{f_c}c_{a1}^{1.5}| \text{ (Eq. 17.5.2.2a \& Eq. 17.5.2.2b)}$$

l_e (in)	d_a (in)	λ_a	f_c (psi)	c_{a1} (in)	V_{by} (lb)
3.00	0.375	1.00	2500	17.75	24294

$$\phi V_{cbgy} = \phi (A_{Vc} / A_{Vco}) \Psi_{ec,V} \Psi_{ed,V} \Psi_{c,V} \Psi_{h,V} V_{by} \text{ (Sec. 17.3.1 \& Eq. 17.5.2.1b)}$$

A_{Vc} (in ²)	A_{Vco} (in ²)	$\Psi_{ec,V}$	$\Psi_{ed,V}$	$\Psi_{c,V}$	$\Psi_{h,V}$	V_{by} (lb)	ϕ	ϕV_{cbgy} (lb)
852.00	1417.78	1.000	0.861	1.000	1.000	24294	0.70	8794

Shear parallel to edge in x-direction:

$$V_{by} = \min|7(l_e/d_a)^{0.2}\sqrt{d_a}\lambda_a\sqrt{f_c}c_{a1}^{1.5}; 9\lambda_a\sqrt{f_c}c_{a1}^{1.5}| \text{ (Eq. 17.5.2.2a \& Eq. 17.5.2.2b)}$$

l_e (in)	d_a (in)	λ_a	f_c (psi)	c_{a1} (in)	V_{by} (lb)
3.00	0.375	1.00	2500	14.25	17475

$$\phi V_{cbgx} = \phi (2)(A_{Vc} / A_{Vco}) \Psi_{ec,V} \Psi_{ed,V} \Psi_{c,V} \Psi_{h,V} V_{by} \text{ (Sec. 17.3.1, 17.5.2.1(c) \& Eq. 17.5.2.1b)}$$

A_{Vc} (in ²)	A_{Vco} (in ²)	$\Psi_{ec,V}$	$\Psi_{ed,V}$	$\Psi_{c,V}$	$\Psi_{h,V}$	V_{by} (lb)	ϕ	ϕV_{cbgx} (lb)
684.00	913.78	1.000	1.000	1.000	1.000	17475	0.70	18313

Shear parallel to edge in y-direction:

$$V_{bx} = \min|7(l_e/d_a)^{0.2}\sqrt{d_a}\lambda_a\sqrt{f_c}c_{a1}^{1.5}; 9\lambda_a\sqrt{f_c}c_{a1}^{1.5}| \text{ (Eq. 17.5.2.2a \& Eq. 17.5.2.2b)}$$

l_e (in)	d_a (in)	λ_a	f_c (psi)	c_{a1} (in)	V_{bx} (lb)
3.00	0.375	1.00	2500	14.25	17475

$$\phi V_{cbgy} = \phi (2)(A_{Vc} / A_{Vco}) \Psi_{ec,V} \Psi_{ed,V} \Psi_{c,V} \Psi_{h,V} V_{bx} \text{ (Sec. 17.3.1, 17.5.2.1(c) \& Eq. 17.5.2.1b)}$$

A_{Vc} (in ²)	A_{Vco} (in ²)	$\Psi_{ec,V}$	$\Psi_{ed,V}$	$\Psi_{c,V}$	$\Psi_{h,V}$	V_{bx} (lb)	ϕ	ϕV_{cbgy} (lb)
836.30	913.78	1.000	1.000	1.000	1.000	17475	0.70	22391

10. Concrete Pryout Strength of Anchor in Shear (Sec. 17.5.3)

$$\phi V_{cp} = \phi \min|K_{cp}N_{ag}; K_{cp}N_{cbg}| = \phi \min|K_{cp}(A_{Na} / A_{Na0}) \Psi_{ec,Na} \Psi_{ed,Na} \Psi_{cp,Na} N_{ba}; K_{cp}(A_{Nc} / A_{Nco}) \Psi_{ec,N} \Psi_{ed,N} \Psi_{c,N} \Psi_{cp,N} N_b| \text{ (Sec. 17.3.1 \& Eq. 17.5.3.1b)}$$

K_{cp}	A_{Na} (in ²)	A_{Na0} (in ²)	$\Psi_{ed,Na}$	$\Psi_{ec,Na}$	$\Psi_{cp,Na}$	N_{ba} (lb)	N_a (lb)
2.0	198.45	112.09	1.000	1.000	1.000	6343	11230

A_{Nc} (in ²)	A_{Nco} (in ²)	$\Psi_{ec,N}$	$\Psi_{ed,N}$	$\Psi_{c,N}$	$\Psi_{cp,N}$	N_b (lb)	N_{cb} (lb)	ϕ
240.25	144.00	1.000	1.000	1.000	1.000	6800	11345	0.70

Input data and results must be checked for agreement with the existing circumstances, the standards and guidelines must be checked for plausibility.



Company:		Date:	5/14/2018
Engineer:		Page:	6/6
Project:			
Address:			
Phone:			
E-mail:			

ϕV_{cpq} (lb)
15722

11. Results

Interaction of Tensile and Shear Forces (Sec. R17.6)

Tension	Factored Load, N_{ua} (lb)	Design Strength, ϕN_n (lb)	Ratio	Status
Steel	1171	3394	0.35	Pass
Concrete breakout	4684	7374	0.64	Pass
Adhesive	4684	6176	0.76	Pass (Governs)

Shear	Factored Load, V_{ua} (lb)	Design Strength, ϕV_n (lb)	Ratio	Status
Steel	784	1765	0.44	Pass (Governs)
T Concrete breakout x+	77	12195	0.01	Pass
T Concrete breakout y-	3134	8794	0.36	Pass
Concrete breakout y-	39	18313	0.00	Pass
Concrete breakout x-	1567	22391	0.07	Pass
Concrete breakout, combined	-	-	0.36	Pass
Pryout	3135	15722	0.20	Pass

Interaction check	$(N_{ua}/\phi N_{ua})^{5/3}$	$(V_{ua}/\phi V_{ua})^{5/3}$	Combined Ratio	Permissible	Status
Sec. R17.6	0.63	0.26	88.9%	1.0	Pass

SET-3G w/ 3/8"Ø F1554 Gr. 36 with hef = 4.000 inch meets the selected design criteria.

12. Warnings

- Designer must exercise own judgement to determine if this design is suitable.
- Refer to manufacturer's product literature for hole cleaning and installation instructions.



JOB NO.: U2716-0281-211

DESIGNED: STB

Racking Analysis

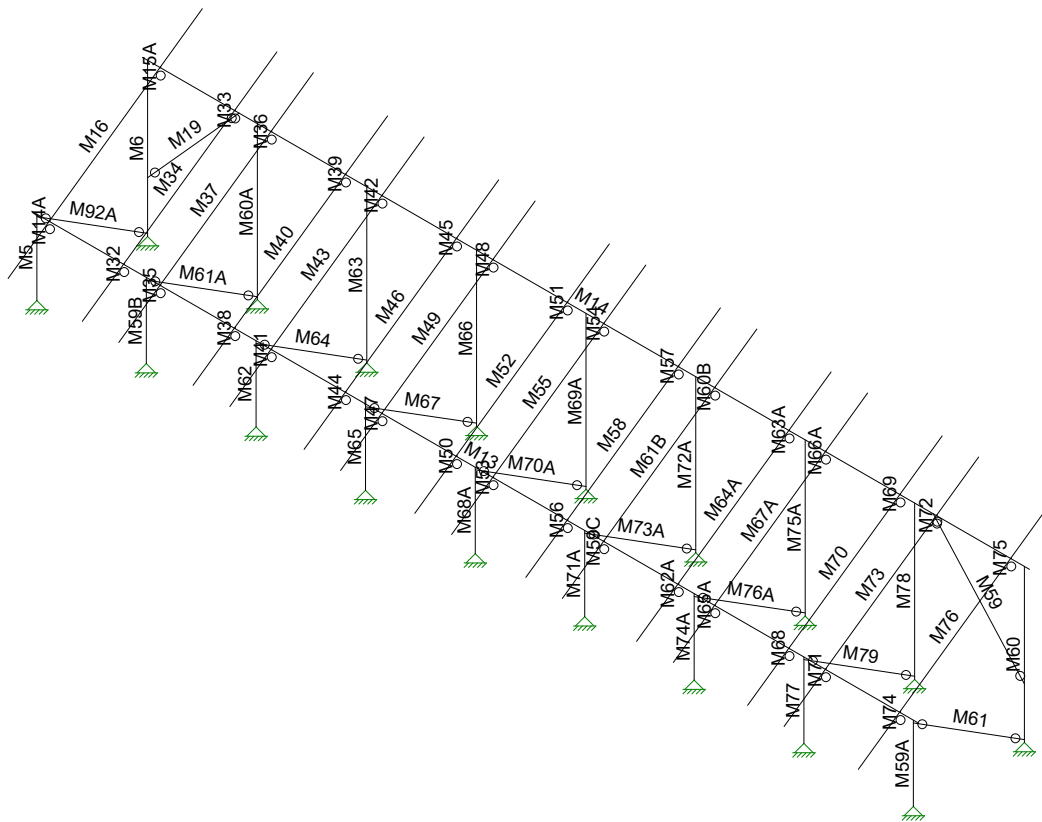

Vector Structural Engineeri...
STB
U2716-0281-211

Ground Mount

SK - 3

Mar 30, 2021 at 3:37 PM

Sunmodo Sunturf A10 (85x45).r3d

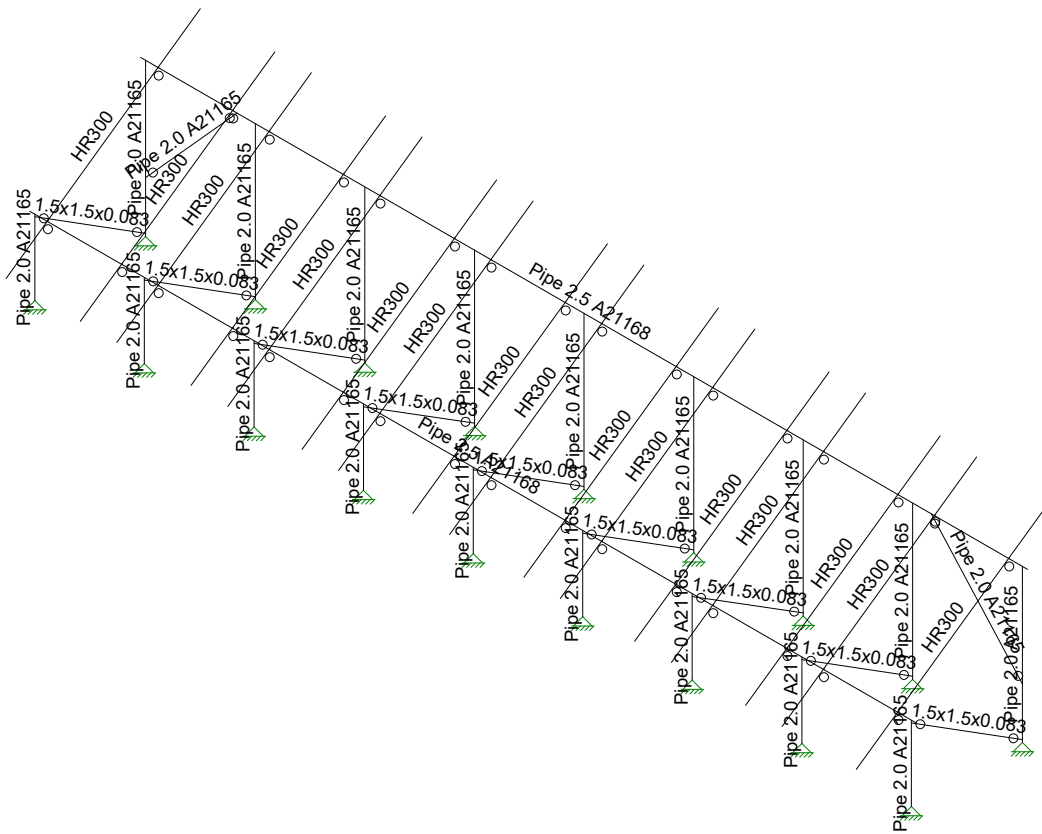

Vector Structural Engineeri...
 STB
 U2716-0281-211

Ground Mount

SK - 4
 Mar 30, 2021 at 3:37 PM
 Sunmodo Sunturf A10 (85x45).r3d

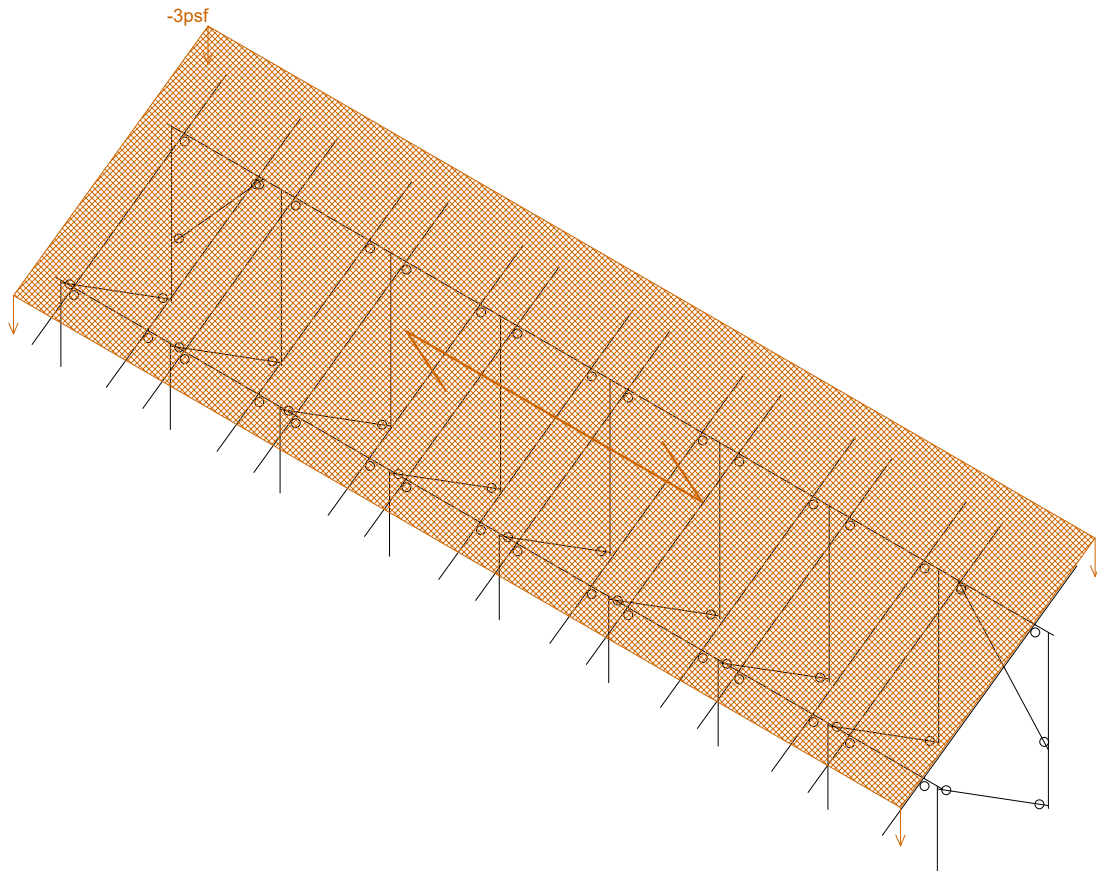

Loads: BLC 2, Solar Panel Weight

Vector Structural Engineeri...	Ground Mount	SK - 5
STB		Mar 30, 2021 at 3:38 PM
U2716-0281-211		Sunmodo Sunturf A10 (85x45).r3d

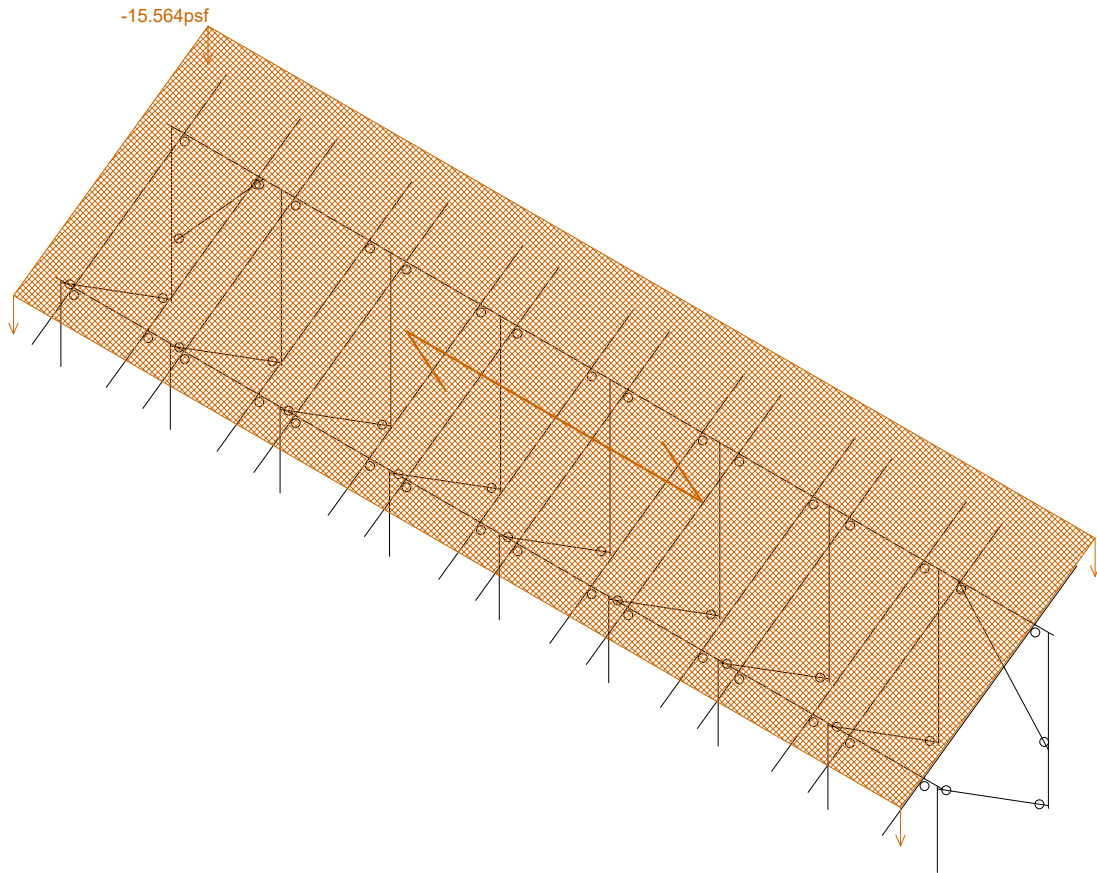

Loads: BLC 3, Roof Live/Snow

Vector Structural Engineeri...

STB

U2716-0281-211

Ground Mount

SK - 6

Mar 30, 2021 at 3:38 PM

Sunmodo Sunturf A10 (85x45).r3d

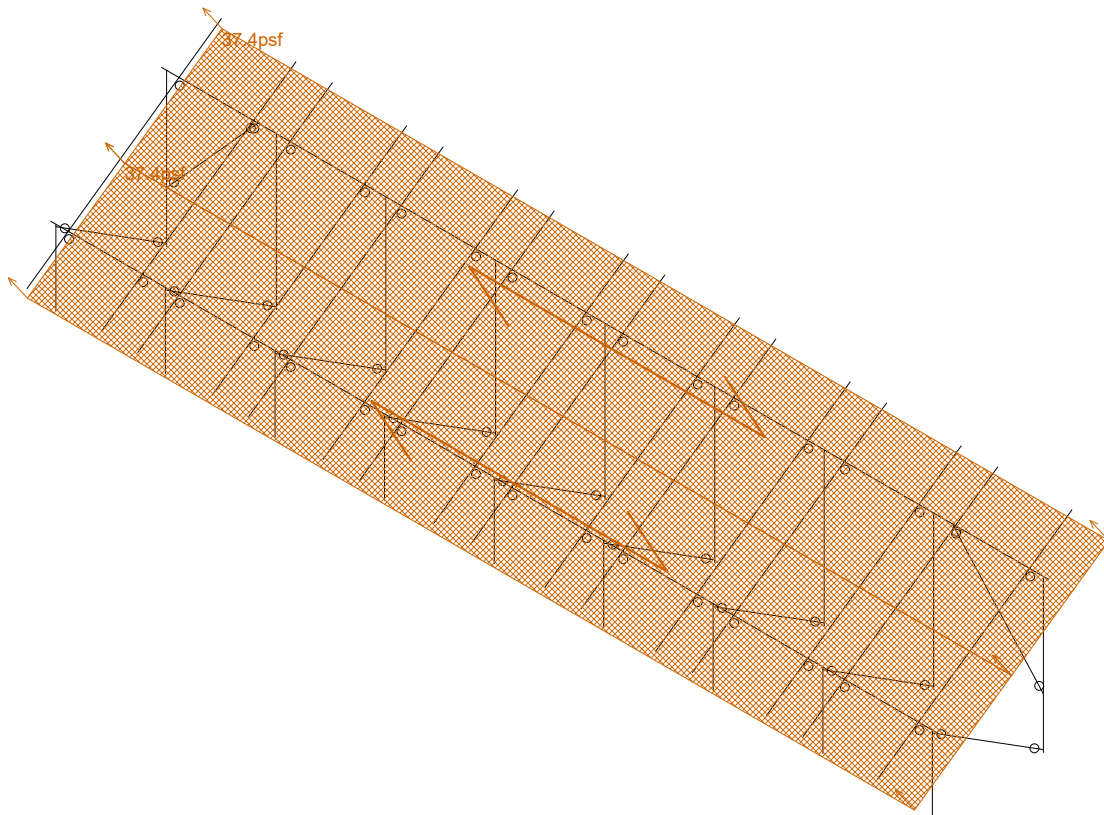

Loads: BLC 4, Wind 1

Vector Structural Engineeri...

STB

U2716-0281-211

Ground Mount

SK - 7

Mar 30, 2021 at 3:38 PM

Sunmodo Sunturf A10 (85x45).r3d

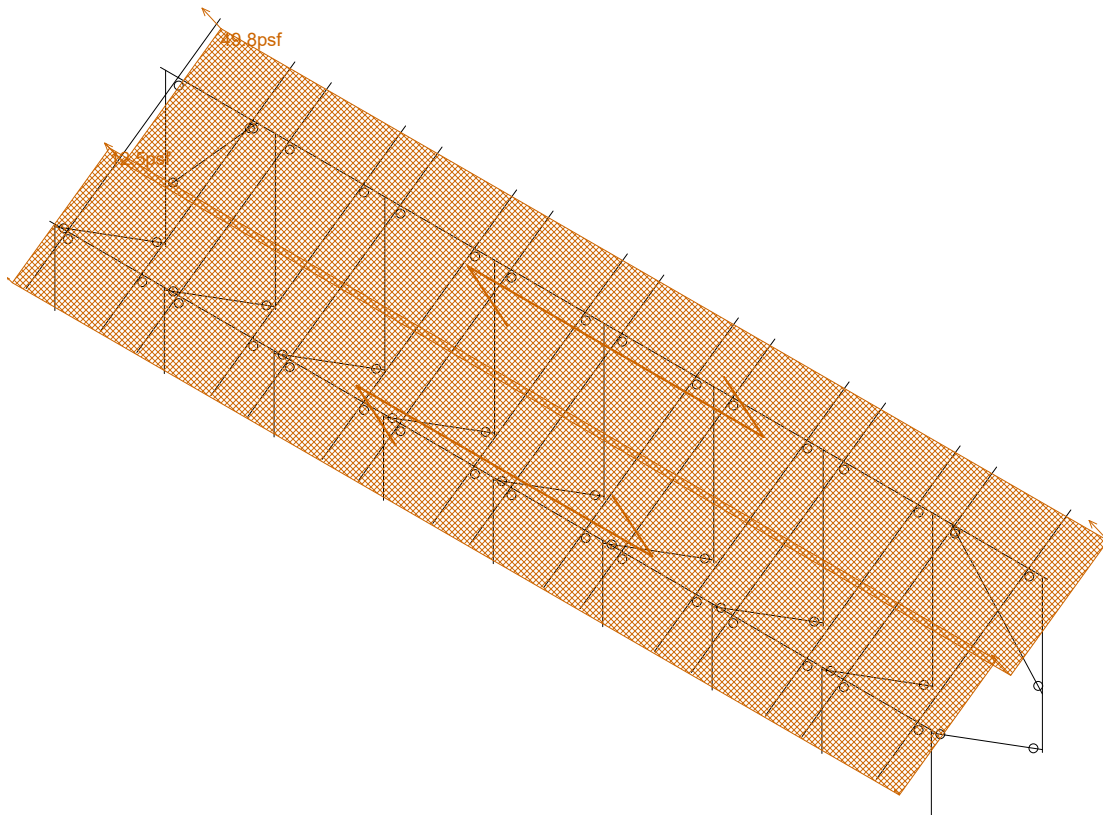

Loads: BLC 5, Wind 2

Vector Structural Engineeri...
STB
U2716-0281-211

Ground Mount

SK - 8

Mar 30, 2021 at 3:38 PM

Sunmodo Sunturf A10 (85x45).r3d

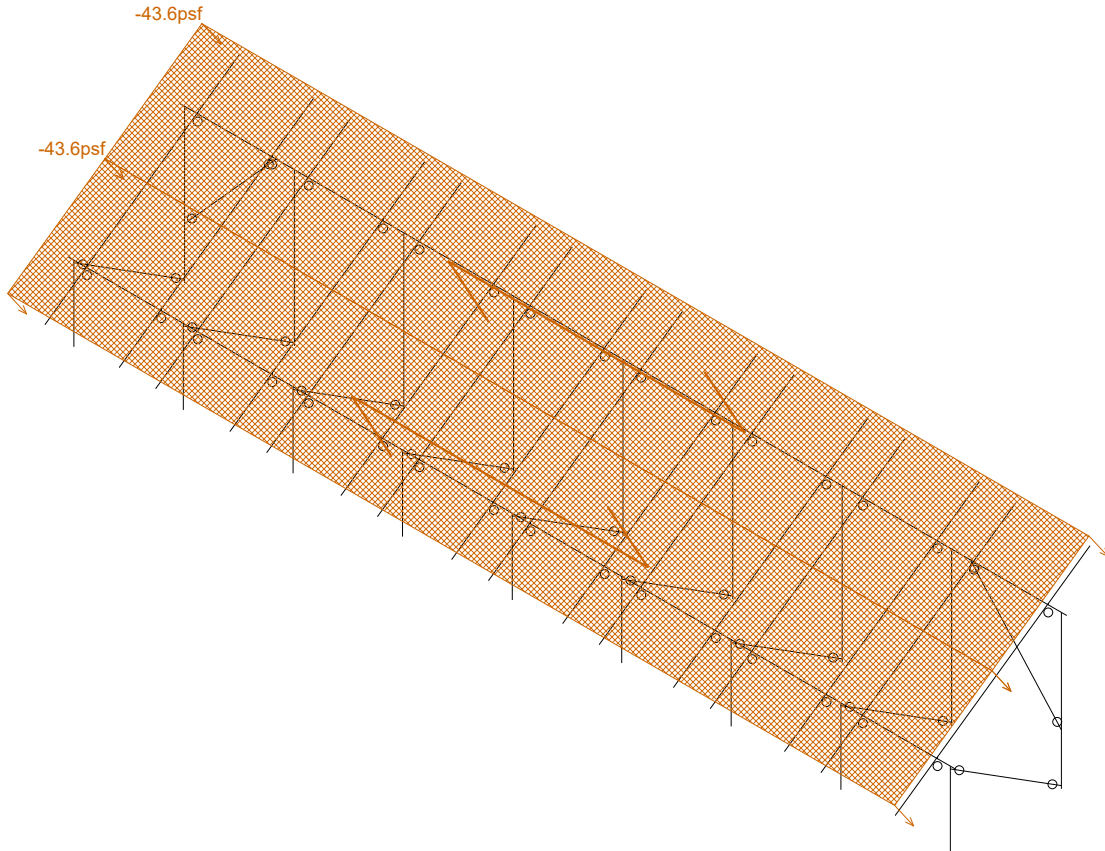

Loads: BLC 6, Wind 3

Vector Structural Engineeri...
STB
U2716-0281-211

Ground Mount

SK - 9

Mar 30, 2021 at 3:39 PM

Sunmodo Sunturf A10 (85x45).r3d

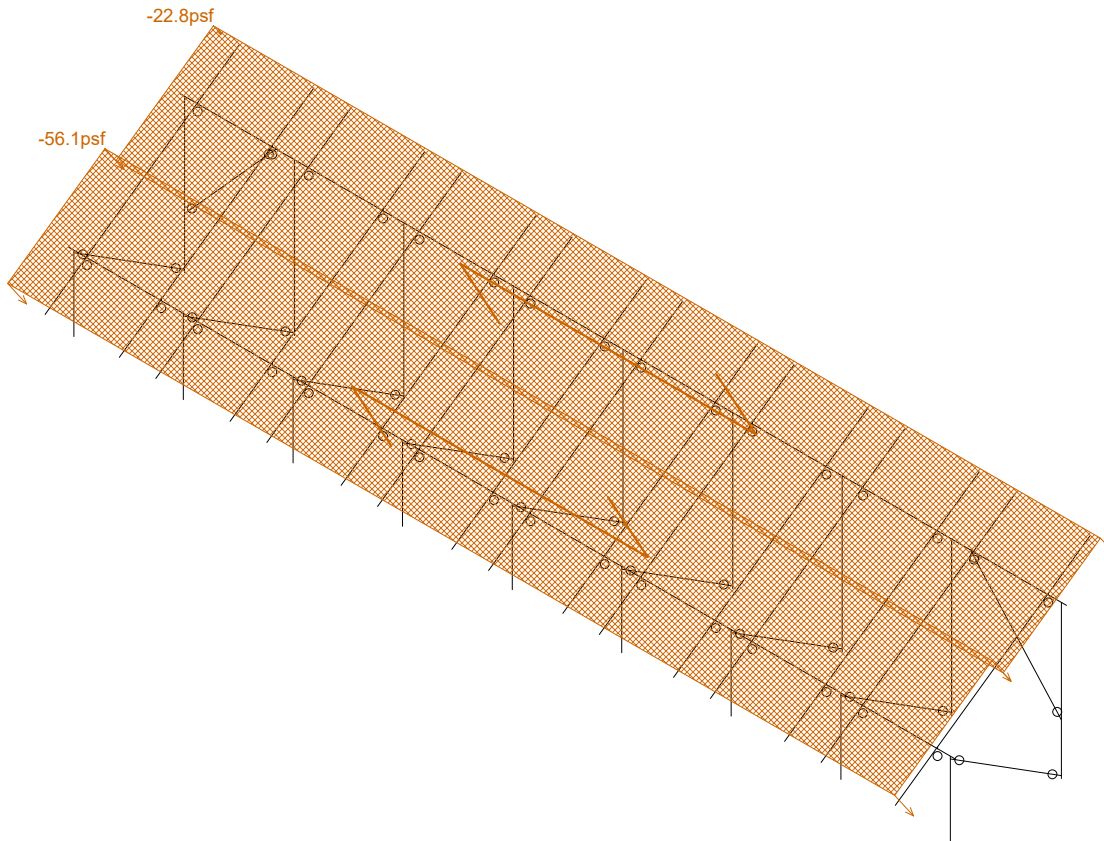

Loads: BLC 7, Wind 4

Vector Structural Engineeri...
STB
U2716-0281-211

Ground Mount

SK - 10

Mar 30, 2021 at 3:39 PM

Sunmodo Sunturf A10 (85x45).r3d



Code Check
(Env)

- No Calc
- > 1.0
- .90-1.0
- .75-.90
- .50-.75
- 0-.50

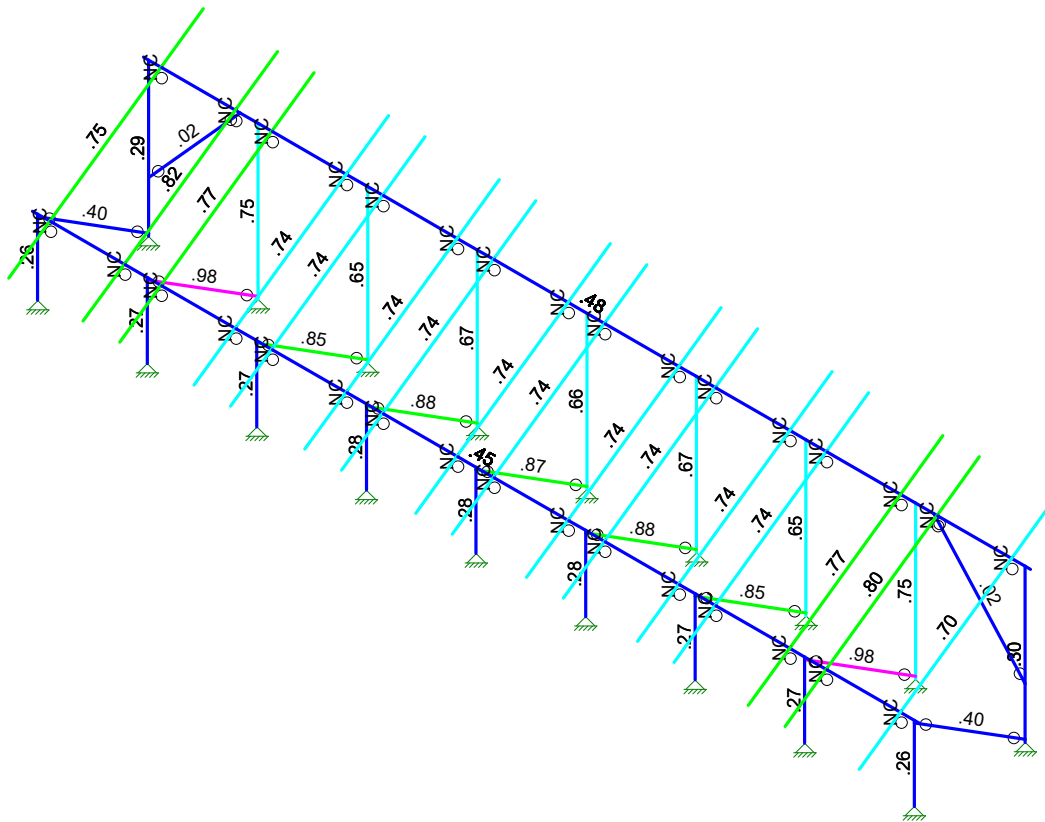

Member Code Checks Displayed (Enveloped)
Envelope Only Solution

Vector Structural Engineeri...	Ground Mount	SK - 1
STB		Mar 30, 2021 at 3:36 PM
U2716-0281-211		Sunmodo Sunturf A10 (85x45).r3d

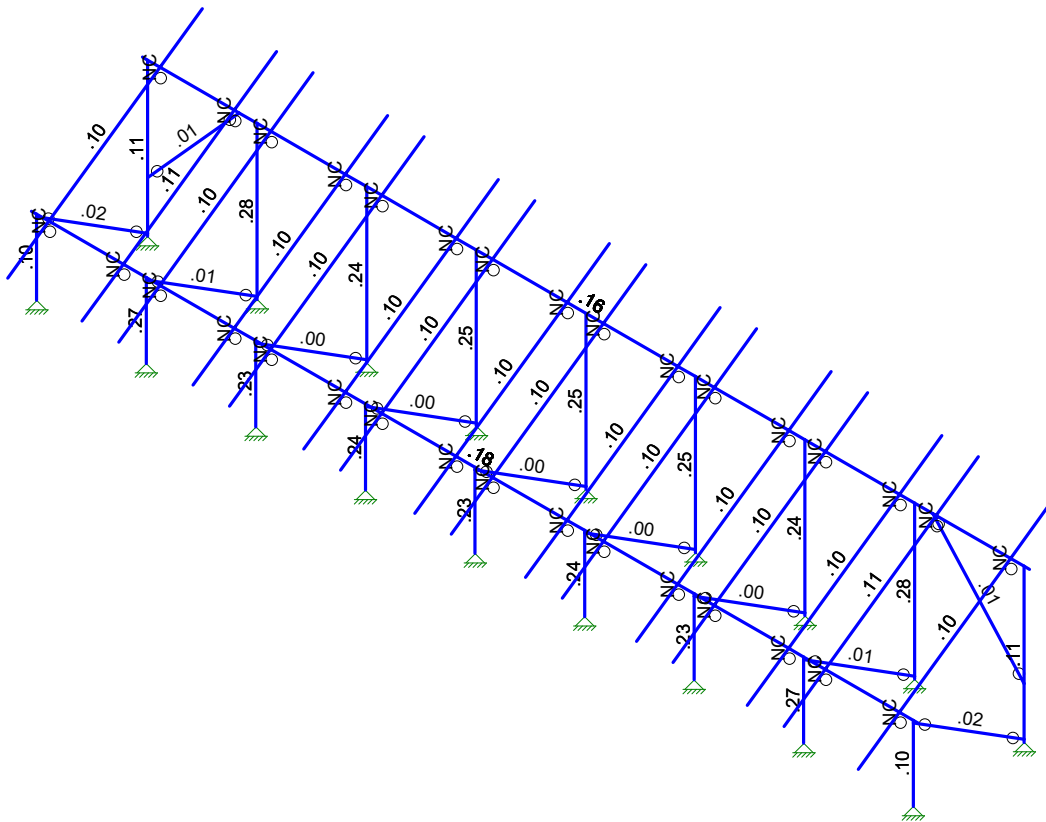
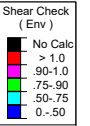

Member Shear Checks Displayed (Enveloped)
Envelope Only Solution

Vector Structural Engineeri...
STB
U2716-0281-211

Ground Mount

SK - 2
Mar 30, 2021 at 3:37 PM
Sunmodo Sunturf A10 (85x45).r3d



(Global) Model Settings

Display Sections for Member Calcs	5
Max Internal Sections for Member Calcs	97
Include Shear Deformation?	Yes
Increase Nailing Capacity for Wind?	Yes
Include Warping?	Yes
Trans Load Btwn Intersecting Wood Wall?	Yes
Area Load Mesh (in^2)	144
Merge Tolerance (in)	.12
P-Delta Analysis Tolerance	0.50%
Include P-Delta for Walls?	Yes
Automatically Iterate Stiffness for Walls?	Yes
Max Iterations for Wall Stiffness	3
Gravity Acceleration (in/sec^2)	386.4
Wall Mesh Size (in)	24
Eigensolution Convergence Tol. (1.E-)	4
Vertical Axis	Y
Global Member Orientation Plane	XZ
Static Solver	Sparse Accelerated
Dynamic Solver	Accelerated Solver

Hot Rolled Steel Code	AISC 15th(360-16): ASD
Adjust Stiffness?	Yes(Iterative)
RISACONNECTION CODE	AISC 15th(360-16): ASD
Cold Formed Steel Code	AISI S100-16: ASD
Wood Code	AWC NDS-15: ASD
Wood Temperature	< 100F
Concrete Code	ACI 318-14
Masonry Code	None
Aluminum Code	AA ADM1-15: ASD - Building
Stainless Steel Code	AISC 14th(360-10): ASD
Adjust Stiffness?	Yes(Iterative)

Number of Shear Regions	4
Region Spacing Increment (in)	4
Biaxial Column Method	Exact Integration
Parame Beta Factor (PCA)	.65
Concrete Stress Block	Rectangular
Use Cracked Sections?	No
Use Cracked Sections Slab?	No
Bad Framing Warnings?	No
Unused Force Warnings?	Yes
Min 1 Bar Diam. Spacing?	No
Concrete Rebar Set	REBAR SET ASTMA615
Min % Steel for Column	1
Max % Steel for Column	8



(Global) Model Settings, Continued

Seismic Code	ASCE 7-16
Seismic Base Elevation (in)	15600
Add Base Weight?	Yes
Ct X	.02
Ct Z	.02
T X (sec)	Not Entered
T Z (sec)	Not Entered
R X	3
R Z	3
Ct Exp. X	.75
Ct Exp. Z	.75
SD1	1
SDS	1
S1	1
TL (sec)	5
Risk Cat	I or II
Drift Cat	Other
Om Z	1
Om X	1
Cd Z	4
Cd X	4
Rho Z	1
Rho X	1

Hot Rolled Steel Properties

	Label	E [ksi]	G [ksi]	Nu	Therm (/1E5 F)	Density[k/ft^3]	Yield[psi]	Ry	Fu[psi]	Rt
1	A992	29000	11154	.3	.65	.49	50000	1.1	65000	1.1
2	A36 Gr.36	29000	11154	.3	.65	.49	36000	1.5	58000	1.2
3	A572 Gr.50	29000	11154	.3	.65	.49	50000	1.1	65000	1.1
4	A500 Gr.B R...	29000	11154	.3	.65	.527	42000	1.4	58000	1.3
5	A500 Gr.B Re...	29000	11154	.3	.65	.527	46000	1.4	58000	1.3
6	A53 Gr.B	29000	11154	.3	.65	.49	35000	1.6	60000	1.2
7	A1085	29000	11154	.3	.65	.49	50000	1.4	65000	1.3

Aluminum Properties

	Label	E [ksi]	G [ksi]	Nu	Therm (...Density[... Table B.4	kt	Ftu[psi]	Fty[psi]	Fcy[psi]	Fsu[psi]	Ct
1	3003-H14	10100	3787.5	.33	1.3 .173 Table B.4-1	1	19000	16000	13000	12000	141
2	6061-T6	10100	3787.5	.33	1.3 .173 Table B.4-2	1	38000	35000	35000	24000	141
3	6063-T5	10100	3787.5	.33	1.3 .173 Table B.4-2	1	22000	16000	16000	13000	141
4	6063-T6	10100	3787.5	.33	1.3 .173 Table B.4-2	1	30000	25000	25000	19000	141
5	5052-H34	10200	3787.5	.33	1.3 .173 Table B.4-1	1	34000	26000	24000	20000	141
6	6061-T6 W	10100	3787.5	.33	1.3 .173 Table B.4-1	1	24000	15000	15000	15000	141
7	6005-T5	10100	3787.5	.33	1.3 .173 Table B.4-1	1	38000	35000	35000	24000	141

Hot Rolled Steel Section Sets

	Label	Shape	Type	Design List	Material	Design R...	A [in2]	Iyy [in4]	Izz [in4]	J [in4]
1	Post	Pipe 2.0 A21165	Column	Pipe	A572 Gr.50	Typical	.776	.499	.499	.998
2	Cross Beam	Pipe 2.5 A21168	Beam	Wide Flange	A572 Gr.50	Typical	.947	.907	.907	1.814
3	Diagonal Brace	1.5x1.5x0.083	HBrace	SquareTube	A572 Gr.50	Typical	.47	.158	.158	.236



Aluminum Section Sets

	Label	Shape	Type	Design List	Material	Design R...	A [in2]	Iyy [in4]	Izz [in4]	J [in4]
1	AL Posts	2.375ODX0.188	Column	Pipe	6005-T5	Typical	1.29	.778	.778	1.54
2	AL Brace	RT1.5x2x0.15625	VBrace	Rectangular Tubes	6005-T5	Typical	.996	.327	.524	.602
3	AL Rails	HR300	Beam	Rectangular Tubes	6005-T5	Typical	.74	.253	.727	.578
4	AL Cross Beam	Cross Rail	Beam	Rectangular Tubes	6005-T5	Typical	1.909	1.97	4.366	4.017

Member Area Loads (BLC 2 : Solar Panel Weight)

	Joint A	Joint B	Joint C	Joint D	Direction	Distribution	Magnitude[psf]
1	N197	N200	N199	N196	Y	A-B	-3

Member Area Loads (BLC 3 : Roof Live/Snow)

	Joint A	Joint B	Joint C	Joint D	Direction	Distribution	Magnitude[psf]
1	N197	N200	N199	N196	PY	A-B	-19

Member Area Loads (BLC 4 : Wind 1)

	Joint A	Joint B	Joint C	Joint D	Direction	Distribution	Magnitude[psf]
1	N197	N119B	N120B	N200	Perp	B-C	37.4
2	N119B	N196	N199	N120B	Perp	B-C	37.4

Member Area Loads (BLC 5 : Wind 2)

	Joint A	Joint B	Joint C	Joint D	Direction	Distribution	Magnitude[psf]
1	N197	N119B	N120B	N200	Perp	B-C	49.8
2	N119B	N196	N199	N120B	Perp	B-C	12.5

Member Area Loads (BLC 6 : Wind 3)

	Joint A	Joint B	Joint C	Joint D	Direction	Distribution	Magnitude[psf]
1	N197	N119B	N120B	N200	Perp	B-C	-43.6
2	N119B	N196	N199	N120B	Perp	B-C	-43.6

Member Area Loads (BLC 7 : Wind 4)

	Joint A	Joint B	Joint C	Joint D	Direction	Distribution	Magnitude[psf]
1	N197	N119B	N120B	N200	Perp	B-C	-22.8
2	N119B	N196	N199	N120B	Perp	B-C	-56.1

Basic Load Cases

	BLC Description	Category	X Gravity	Y Gravity	Z Gravity	Joint	Point	Distributed	Area(M...Surface...
1	Self Weight	DL		-1.05					
2	Solar Panel Weight	DL							1
3	Roof Live/Snow	RLL							1
4	Wind 1	OL1							2
5	Wind 2	OL2							2
6	Wind 3	OL3							2
7	Wind 4	OL4							2
8	BLC 2 Transient Area ...	None						40	
9	BLC 3 Transient Area ...	None						40	
10	BLC 4 Transient Area ...	None						160	
11	BLC 5 Transient Area ...	None						160	
12	BLC 6 Transient Area ...	None						160	
13	BLC 7 Transient Area ...	None						160	



Load Combinations

	Description	S...	PD...	SRSS	BLC	Fa...	BLC	Fa...	BLC	Fa...	B...	Fa...	B...	Fa...	B...	Fa...	B...	Fa...	B...	Fa...	B...	Fa...	B...
1	ASD Loads		Y																				
2	1.0 D	Yes	Y		DL	1																	
3	1.0 D + 1.0 S	Yes	Y		DL	1	RLL	1															
4	1.0 D + 0.6 W1	Yes	Y		DL	1	RLL		OL1	.6													
5	1.0 D + 0.6 W2	Yes	Y		DL	1	RLL		OL2	.6													
6	1.0 D + 0.6 W3	Yes	Y		DL	1	RLL		OL3	.6													
7	1.0 D + 0.6 W4	Yes	Y		DL	1	RLL		OL4	.6													
8	1.0 D + 0.45 W1 + 0....	Yes	Y		DL	1	RLL	.75	OL1	.45													
9	1.0 D + 0.45 W2 + 0....	Yes	Y		DL	1	RLL	.75	OL2	.45													
10	1.0 D + 0.45 W3 + 0....	Yes	Y		DL	1	RLL	.75	OL3	.45													
11	1.0 D + 0.45 W4 + 0....	Yes	Y		DL	1	RLL	.75	OL4	.45													
12	0.6 D + 0.6 W1	Yes	Y		DL	.6	RLL		OL1	.6													
13	0.6 D + 0.6 W2	Yes	Y		DL	.6	RLL		OL2	.6													
14	0.6 D + 0.6 W3	Yes	Y		DL	.6	RLL		OL3	.6													
15	0.6 D + 0.6 W4	Yes	Y		DL	.6	RLL		OL4	.6													
16			Y																				
17	LRFD Loads		Y																				
18	1.4 D		Y		DL	1.4	RLL																
19	1.2 D + 1.6 S + 0.5 W1		Y		DL	1.2	RLL	1.6	OL1	.5													
20	1.2 D + 1.6 S + 0.5 W2		Y		DL	1.2	RLL	1.6	OL2	.5													
21	1.2 D + 1.6 S + 0.5 W3		Y		DL	1.2	RLL	1.6	OL3	.5													
22	1.2 D + 1.6 S + 0.5 W4		Y		DL	1.2	RLL	1.6	OL4	.5													
23	1.2 D + 1.0 W1		Y		DL	1.2	RLL		OL1	1													
24	1.2 D + 1.0 W2		Y		DL	1.2	RLL		OL2	1													
25	1.2 D + 1.0 W3		Y		DL	1.2	RLL		OL3	1													
26	1.2 D + 1.0 W4		Y		DL	1.2	RLL		OL4	1													
27	0.9 D + 1.0 W1		Y		DL	.9	RLL		OL1	1													
28	0.9 D + 1.0 W2		Y		DL	.9	RLL		OL2	1													
29	0.9 D + 1.0 W3		Y		DL	.9	RLL		OL3	1													
30	0.9 D + 1.0 W4		Y		DL	.9	RLL		OL4	1													

Envelope Joint Reactions

	Joint	X [lb]	LC	Y [lb]	LC	Z [lb]	LC	MX [lb-ft]	LC	MY [lb-ft]	LC	MZ [lb-ft]	LC
1	N2	max 63.025	11	738.149	9	43.103	4	0	15	0	15	0	15
2		min -18.401	12	-136.861	14	-50.513	6	0	2	0	2	0	2
3	N1	max 3.974	8	1344.494	6	746.481	14	0	15	0	15	0	15
4		min -2.263	14	-1069.033	13	-641.3...	4	0	2	0	2	0	2
5	N123	max 1.907	14	1354.274	6	746.306	14	0	15	0	15	0	15
6		min -3.911	8	-1071.651	13	-641.2...	4	0	2	0	2	0	2
7	N124	max 17.854	12	739.535	9	43.105	4	0	15	0	15	0	15
8		min -62.377	11	-146.909	14	-50.496	6	0	2	0	2	0	2
9	N123A	max 3.913	13	3411.385	6	1880.4...	6	0	15	0	15	0	15
10		min -6.09	10	-2797.245	13	-1611....	12	0	2	0	2	0	2
11	N124A	max 13.072	12	1751.256	9	66.217	4	0	15	0	15	0	15
12		min -23.145	11	-454.053	14	-76.555	6	0	2	0	2	0	2
13	N129	max .937	10	2948.69	6	1631.3...	14	0	15	0	15	0	15
14		min -.859	13	-2428.26	13	-1400....	4	0	2	0	2	0	2
15	N130	max 1.231	9	1561.077	9	68.239	4	0	15	0	15	0	15
16		min .1	14	-361.913	14	-79.351	6	0	2	0	2	0	2
17	N135	max .138	13	3032.745	6	1682.0...	6	0	15	0	15	0	15
18		min -.372	10	-2494.716	13	-1442....	4	0	2	0	2	0	2
19	N136	max 1.558	12	1593.265	9	69.366	4	0	15	0	15	0	15
20		min -2.159	10	-384.108	14	-80.594	6	0	2	0	2	0	2
21	N141	max .011	15	3012.218	6	1670.3...	6	0	15	0	15	0	15



Envelope Joint Reactions (Continued)

Joint	X [lb]	LC	Y [lb]	LC	Z [lb]	LC	MX [lb-ft]	LC	MY [lb-ft]	LC	MZ [lb-ft]	LC		
22	min	-.031	13	-2478.756	13	-1433...	4	0	2	0	2	0	2	
23	N142	max	.024	4	1586.635	9	69.443	4	0	15	0	15	0	15
24		min	-.057	15	-379.294	14	-80.705	6	0	2	0	2	0	2
25	N147B	max	.365	10	3032.932	6	1682.0...	6	0	15	0	15	0	15
26		min	-.204	13	-2494.779	13	-1442...	4	0	2	0	2	0	2
27	N148A	max	2.147	10	1593.282	9	69.367	4	0	15	0	15	0	15
28		min	-1.496	12	-384.233	14	-80.594	6	0	2	0	2	0	2
29	N153A	max	.803	13	2947.778	6	1631.3...	14	0	15	0	15	0	15
30		min	-.967	10	-2428.018	13	-1400...	4	0	2	0	2	0	2
31	N154A	max	-.091	14	1560.981	9	68.24	4	0	15	0	15	0	15
32		min	-1.235	9	-361.217	14	-79.354	6	0	2	0	2	0	2
33	N161	max	6.161	10	3417.976	6	1880.61	6	0	15	0	15	0	15
34		min	-4.011	13	-2798.899	13	-1611...	12	0	2	0	2	0	2
35	N162	max	22.795	11	1752.332	9	66.23	4	0	15	0	15	0	15
36		min	-12.771	12	-460.269	14	-76.549	6	0	2	0	2	0	2
37	Totals:	max	0	13	27570.208	10	12895...	6						
38		min	0	10	-13562.733	12	-1106...	4						

Envelope AISC 15th(360-16): ASD Steel Code Checks

Member	Shape	Code Check	Loc[in]	LC	Shear	...	Loc[in]	Dir	LC	Pnc/om	[..Pnt/om	[lb]	Mnyy/om..	Mnzz/om..	Cb	Eqn
1	M5	Pipe 2.0 A2...	.261	56.018	11	.102	56.018		6	16015.401	23232.186	1397.505	1397.505	1...	H1-1b	
2	M6	Pipe 2.0 A2...	.294	1.218	6	.109	0		6	5487.857	23232.186	1397.505	1397.505	2...	H1-1a	
3	M13	Pipe 2.5 A2...	.453	340	11	.180	587...		6	14032.946	28358.413	2081.747	2081.747	1	H1-1b	
4	M14	Pipe 2.5 A2...	.483	340	10	.155	587...		10	14032.946	28358.413	2081.747	2081.747	1	H1-1b	
5	M19	Pipe 2.0 A2...	.016	53.532	5	.013	104...		7	6821.523	23232.186	1397.505	1397.505	1...	H1-1b	
6	M92A	1.5x1.5x0.083	.398	52.313	6	.017	0	y	3	2353.669	14085.15	624.421	624.421	1...	H1-1a	
7	M59	Pipe 2.0 A2...	.016	53.446	5	.013	104...		7	6843.259	23232.186	1397.505	1397.505	1...	H1-1b	
8	M59A	Pipe 2.0 A2...	.259	56.018	11	.102	56.018		6	16015.401	23232.186	1397.505	1397.505	1...	H1-1b	
9	M60	Pipe 2.0 A2...	.296	1.218	6	.109	0		6	5487.857	23232.186	1397.505	1397.505	2...	H1-1a	
10	M61	1.5x1.5x0.083	.398	52.313	6	.018	100...	y	3	2353.669	14085.15	624.421	624.421	1...	H1-1a	
11	M59B	Pipe 2.0 A2...	.272	55.422	14	.268	56.018		6	16015.401	23232.186	1397.505	1397.505	1...	H1-1b	
12	M60A	Pipe 2.0 A2...	.748	1.218	6	.281	0		6	5487.857	23232.186	1397.505	1397.505	1...	H1-1a	
13	M61A	1.5x1.5x0.083	.982	52.313	6	.013	0	y	10	2353.669	14085.15	624.421	624.421	1...	H1-1a	
14	M62	Pipe 2.0 A2...	.271	55.422	14	.229	56.018		6	16015.401	23232.186	1397.505	1397.505	1...	H1-1b	
15	M63	Pipe 2.0 A2...	.646	1.218	6	.243	0		6	5487.857	23232.186	1397.505	1397.505	1...	H1-1a	
16	M64	1.5x1.5x0.083	.853	52.313	6	.002	100...	y	9	2353.669	14085.15	624.421	624.421	1...	H1-1a	
17	M65	Pipe 2.0 A2...	.276	55.422	14	.236	56.018		6	16015.401	23232.186	1397.505	1397.505	1...	H1-1b	
18	M66	Pipe 2.0 A2...	.665	1.218	6	.250	0		6	5487.857	23232.186	1397.505	1397.505	2...	H1-1a	
19	M67	1.5x1.5x0.083	.879	52.313	6	.003	0	y	6	2353.669	14085.15	624.421	624.421	1...	H1-1a	
20	M68A	Pipe 2.0 A2...	.276	55.422	14	.234	56.018		6	16015.401	23232.186	1397.505	1397.505	1...	H1-1b	
21	M69A	Pipe 2.0 A2...	.661	1.218	6	.249	0		6	5487.857	23232.186	1397.505	1397.505	1...	H1-1a	
22	M70A	1.5x1.5x0.083	.873	52.313	6	.002	0	y	10	2353.669	14085.15	624.421	624.421	1...	H1-1a	
23	M71A	Pipe 2.0 A2...	.276	55.422	14	.236	56.018		6	16015.401	23232.186	1397.505	1397.505	1...	H1-1b	
24	M72A	Pipe 2.0 A2...	.665	1.218	6	.250	0		6	5487.857	23232.186	1397.505	1397.505	2...	H1-1a	
25	M73A	1.5x1.5x0.083	.879	52.313	6	.003	0	y	10	2353.669	14085.15	624.421	624.421	1...	H1-1a	
26	M74A	Pipe 2.0 A2...	.271	55.422	14	.229	56.018		6	16015.401	23232.186	1397.505	1397.505	1...	H1-1b	
27	M75A	Pipe 2.0 A2...	.646	1.218	6	.243	0		6	5487.857	23232.186	1397.505	1397.505	1...	H1-1a	
28	M76A	1.5x1.5x0.083	.853	52.313	6	.002	100...	y	9	2353.669	14085.15	624.421	624.421	1...	H1-1a	
29	M77	Pipe 2.0 A2...	.271	55.422	14	.269	56.018		6	16015.401	23232.186	1397.505	1397.505	1...	H1-1b	
30	M78	Pipe 2.0 A2...	.749	1.218	6	.281	0		6	5487.857	23232.186	1397.505	1397.505	1...	H1-1a	
31	M79	1.5x1.5x0.083	.983	52.313	6	.013	0	y	10	2353.669	14085.15	624.421	624.421	1...	H1-1a	



Envelope AA ADM1-15: ASD - Building Aluminum Code Checks

Member	Shape	Code C...	Loc[in]	LC	Shear ...	Loc[in]	Dir	LC	Pnc/O...	Pnt/Om...	Mny/O...	Mnz/O...	Vny/O...	Vnz/O...	Cb	Eqn
1	M16	HR300	.750	39.813	7	.095	39.813	y	11	3465.417	14429....	560.361	934.132	5656.689	2605.145	2... H.1-1
2	M34	HR300	.822	39.813	7	.107	39.813	y	11	3465.417	14429....	560.361	934.132	5656.689	2605.145	2... H.1-1
3	M37	HR300	.773	142.1...	13	.098	39.813	y	11	3465.417	14429....	560.361	934.132	5656.689	2605.145	1... H.1-1
4	M40	HR300	.740	39.813	11	.099	39.813	y	11	3465.417	14429....	560.361	934.132	5656.689	2605.145	1... H.1-1
5	M43	HR300	.739	39.813	11	.099	39.813	y	11	3465.417	14429....	560.361	934.132	5656.689	2605.145	1... H.1-1
6	M46	HR300	.741	39.813	11	.099	39.813	y	11	3465.417	14429....	560.361	934.132	5656.689	2605.145	1... H.1-1
7	M49	HR300	.740	39.813	11	.099	39.813	y	11	3465.417	14429....	560.361	934.132	5656.689	2605.145	1... H.1-1
8	M52	HR300	.740	39.813	11	.099	39.813	y	11	3465.417	14429....	560.361	934.132	5656.689	2605.145	1... H.1-1
9	M55	HR300	.740	39.813	11	.099	39.813	y	11	3465.417	14429....	560.361	934.132	5656.689	2605.145	1... H.1-1
10	M58	HR300	.740	39.813	11	.099	39.813	y	11	3465.417	14429....	560.361	934.132	5656.689	2605.145	1... H.1-1
11	M61B	HR300	.741	39.813	11	.099	39.813	y	11	3465.417	14429....	560.361	934.132	5656.689	2605.145	1... H.1-1
12	M64A	HR300	.739	39.813	11	.099	39.813	y	11	3465.417	14429....	560.361	934.132	5656.689	2605.145	1... H.1-1
13	M67A	HR300	.740	39.813	11	.099	39.813	y	11	3465.417	14429....	560.361	934.132	5656.689	2605.145	1... H.1-1
14	M70	HR300	.773	142.1...	13	.098	39.813	y	11	3465.417	14429....	560.361	934.132	5656.689	2605.145	1... H.1-1
15	M73	HR300	.801	39.813	7	.107	39.813	y	11	3465.417	14429....	560.361	934.132	5656.689	2605.145	2... H.1-1
16	M76	HR300	.698	39.813	7	.096	39.813	y	11	3465.417	14429....	560.361	934.132	5656.689	2605.145	2... H.1-1