

04/22/2021

VSE Project Number: U2716-114-191

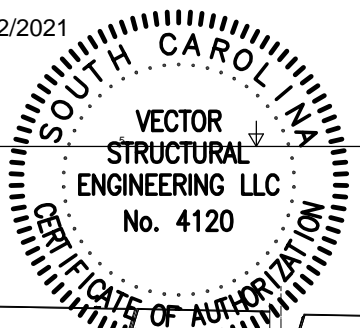
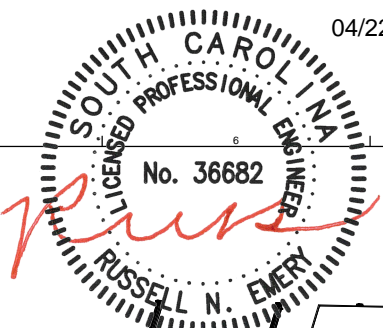

651 W. GALENA PARK BLVD. STE. 101 DRAPER, UTAH 84020  
 PHONE (801) 990-1775  
 WWW.VECTORSE.COM

**NOTES: UNLESS OTHERWISE SPECIFIED**

- THIS DRAWING IS NOT FOR CONSTRUCTION UNTIL ENGINEERING HAS REVIEWED AND STAMPED THIS DOCUMENT.
- DIMENSIONS SHOWN ARE INCHES.
- THE SELF-BONDING SYSTEM AND SINGLE GROUND LUG IS FOR USE WITH PV MODULES THAT HAVE A MAXIMUM SERIES FUSE RATING OF 30A.
- MATERIALS ARE AS SPECIFIED OR EQUIVALENT:  
 HARDWARE: 304 STAINLESS STEEL  
 FABRICATED EXTRUDED PARTS: 6005-T5 ALUMINUM ALLOY  
 FABRICATED DIE CAST PARTS: ANSI/AA A380 ALUMINUM ALLOY  
 STEEL PIPE: SCHEDULE 40 GALVANIZED  
 ALUMINUM PIPE: SCHEDULE 10 ANODIZED
- THE MAXIMUM PERMISSIBLE LENGTH OF ANY STRUCTURE SHALL BE 200 FT. FOR SYSTEMS USING A SHARED RAIL CONFIGURATION, A THERMAL BREAK IS REQUIRED IN THE RAIL EVERY 40 FT. PER THE DRAWING DETAILS.
- 4LXN-3LXN-2PXN-35DEG-GSM-AGM-BGM-PGM.
- PANEL DIMENSIONS ARE AS FOLLOWS  
 STANDARD (SP): MAX 82"X42"  
 OVERSIZE (OP): MAX 85"X45"
- APPROVED RAIL PROFILES - STANDARD PANELS  
 A20288-XXX (HR300 RAIL), A20297-001 (END CAP), K10343-002 (U-CLAMP KIT);  
 A20145-XXX (HR350 RAIL), A20285-001 (END CAP), K10343-001 (U-CLAMP KIT).
- APPROVED RAIL PROFILES - OVERSIZE PANELS  
 \* A20288-XXX (HR300 RAIL), A20297-001 (END CAP), K10343-002 (U-CLAMP KIT);  
 \* A20145-XXX (HR350 RAIL), A20285-001 (END CAP), K10343-001 (U-CLAMP KIT).
- K10224-XXX END CLAMP KIT OR K10299-XXX ADJ. END CLAMP KIT.
- FOUNDATION TYPES:  
 GSM = GROUND SCREW GROUND MOUNT  
 AGM = HELICAL AUGER GROUND MOUNT  
 PGM = POST-IN-CONCRETE GROUND MOUNT  
 BSM = BALLAST GROUND MOUNT

Packet A5

Model Code	ASCE 7-10
Exposure Category	B and Lower
Wind Speed	140 mph and Lower
Ground Snow Load	70 PSF and Lower
Tilt	35 DEG and Lower

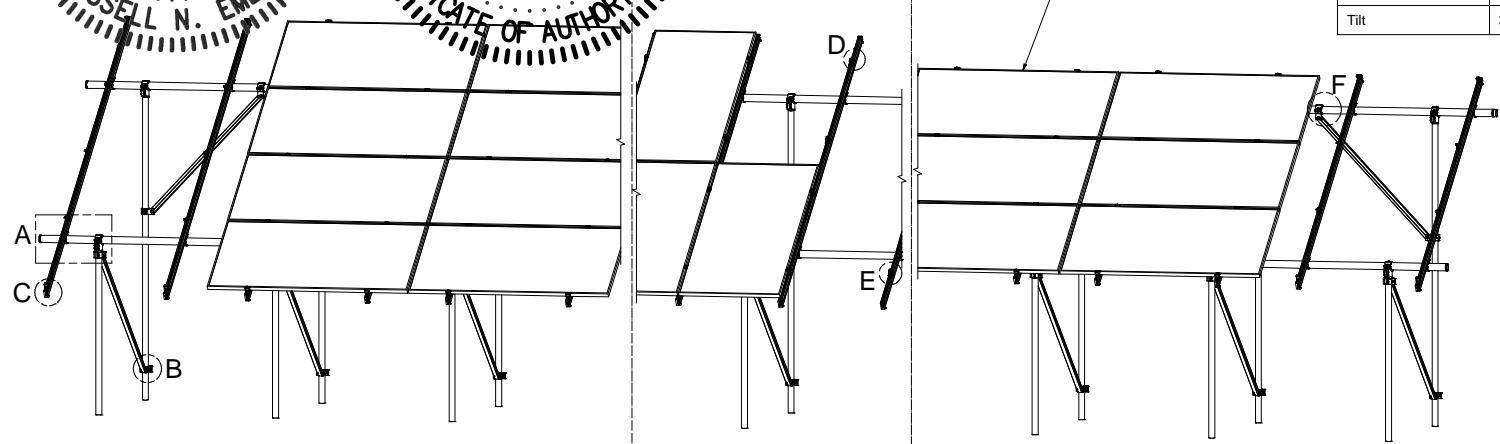

4L  
4-IN-LANDSCAPE

2P  
2-IN-PROTRAIT

3L  
3-IN-LANDSCAPE

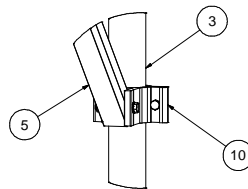
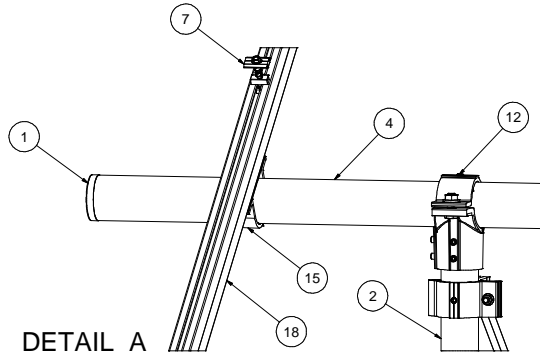

DETAIL B

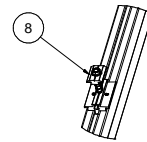

DETAIL D

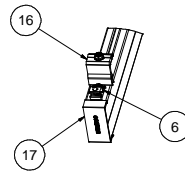

DETAIL C

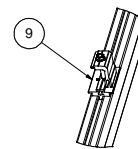

DETAIL E

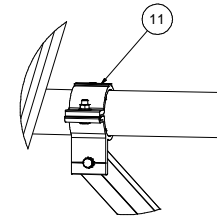

DETAIL F

ITEM	PART NUMBER	DESCRIPTION	QTY
19		PANEL	
18		HELIO-RAIL-VARIES PER NOTE 8 & 9	
17		HELIO-RAIL END CAP-VARIES PER NOTE 8 & 9	
16		END CLAMP KIT. VARIES PER NOTE 10	
15	K10343-001	2.5" AL PIPE U-CLAMP KIT	
14	K10448-001	2.5" PIPE SPLICE KIT	
13	K10342-001	2.5" PIPE SPLICE KIT	
12	K10341-001	2.5" PIPE TEE KIT	
11	K10222-001	2.5" PIPE CLAMP KIT	
10	K10219-001	2" AL PIPE CLAMP KIT	
9	K10183-XXX	LANDSCAPE GROUNDING END CLAMP KIT	
8	K10182-001	LANDSCAPE GROUNDING MID CLAMP KIT	
7	K10180-001	GROUNDING MID-CLAMP KIT WITH T COLLAR BOLT AND GROUNDING BASE	
6	K10179-001	SELF-GROUNDING LUG KIT	
5	A50164-XXX	1.5" SQ. STL TUBE BRACE, L=XXX	
4	A21168-XXX	PIPE, HSS, 2.875" OD X 12 GAUGE, L=XXX	
3	A21165-XXX (REAR)	PIPE, HSS, 2.375" OD X 12 GAUGE, L=XXX	
2	A21165-XXX (FRONT)	PIPE, HSS, 2.375" OD X 12 GAUGE, L=XXX	
1	A20380-001	2.5" PIPE END CAP	

SEE BOM  
 Third Angle Projection  
 PERSONAL USE ONLY  
 ALL RIGHTS RESERVED  
 DATE: 04/21/2021  
 CHECKED BY: [Signature]

**SunModo Corp.**  
 14800 NE 65TH STREET, VANCOUVER WA 98662  
 TITLE: PACKET A5  
 DRAWING NUMBER: D

THIS DRAWING IS CONFIDENTIAL PROPERTY OF SUNMODO AND ITS CONTENTS MAY NOT BE DISCLOSED WITHOUT THE PRIOR WRITTEN CONSENT OF SUNMODO CORP.

SCALE: SHEET 1 of 4

**NOTES:**

- 1. DIMENSIONS LABELED AS MAX ARE MAXIMUM ALLOWABLE AND MAY RESULT IN END POSTS BEING OUTSIDE ARRAY EDGES. MAXIMUM DIMENSIONS MAY BE REDUCED IF DESIRED.
- 2. SEE NOTE 7 OF COVER PAGE FOR PANEL SIZES.

**RAIL SPACING**

LANDSCAPE: PER PANEL MANUFACTURER  
PORTRAIT: PANEL WIDTH + 0.25"

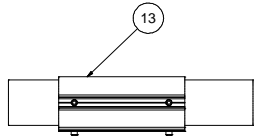

DETAIL G

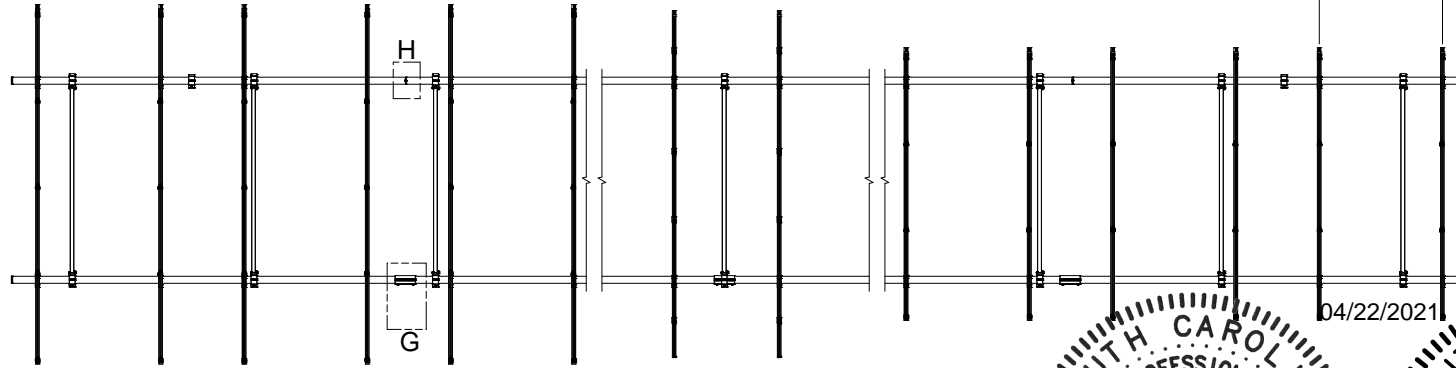

VSE Project Number: U2716-114-191



651 W. GALENA PARK BLVD. STE. 101 DRAPER, UTAH 84020  
PHONE (801) 990-1775  
WWW.VECTORSE.COM

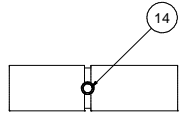
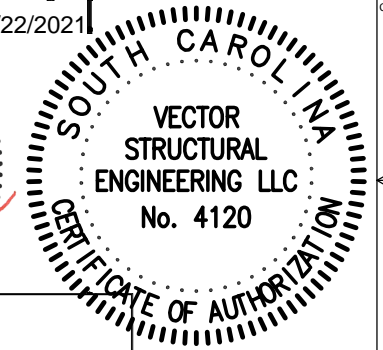
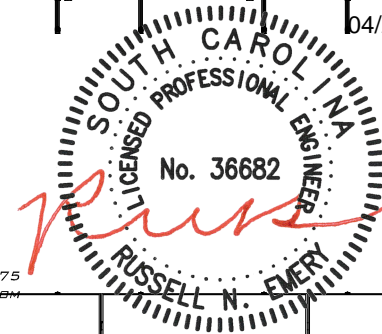

DETAIL H (ALTERNATE)

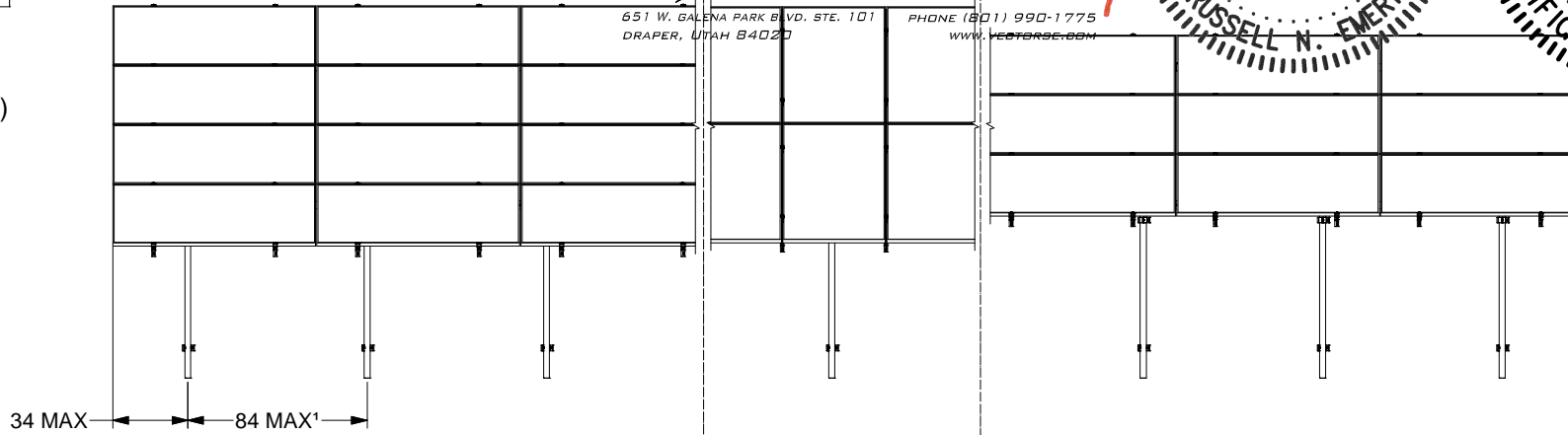

4L  
4-IN-LANDSCAPE

2P  
2-IN-PORTRAIT

3L  
3-IN-LANDSCAPE

<b>SunModo Corp.</b>	
TITLE	PACKET AS
D	DRAWING NUMBER
SCALE:	SHEET 2 of 4 REV

04/22/2021

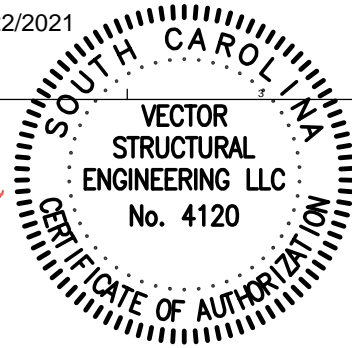
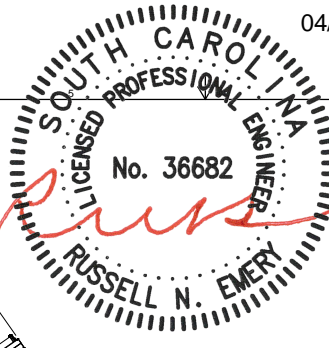

**DIMENSIONS - STANDARD PANEL**

ITEM	4L	2P	3L
A	172	166	130
B	37	34	16
C	55	53	43
D	111	109	99

**DIMENSIONS - OVERSIZE PANEL**

ITEM	4L	2P	3L
A	184	172	140
B	42	36	20
C	58	54	45
D	115	112	103

**NOTES**

1. DIMENSIONS IN TABLE ARE SHOWN AT MAXIMUM TILT & LEADING EDGE HEIGHT. PROJECTS WITH LOWER TILTS & LEADING EDGE HEIGHTS WILL RESULT IN REDUCED DIMENSIONS.
2. MAX DENOTES MAXIMUM PERMISSIBLE DIMENSIONS.
3. SEE NOTE 7 OF COVER PAGE FOR PANEL SIZES.

VSE Project Number: U2716-114-191



851 W. GALENA PARK BLVD. STE. 101 DRAPER, UTAH 84020 PHONE (801) 980-1775 WWW.VECTORSE.COM

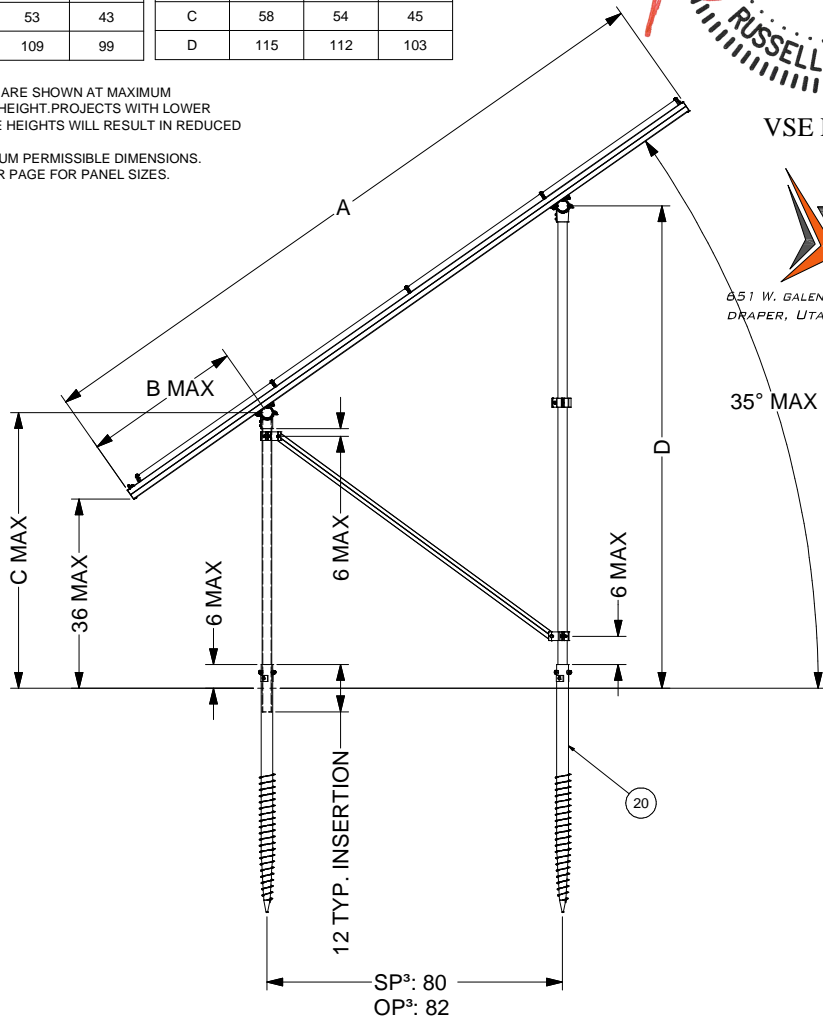

**GROUND SCREW GROUND MOUNT (GSM)**

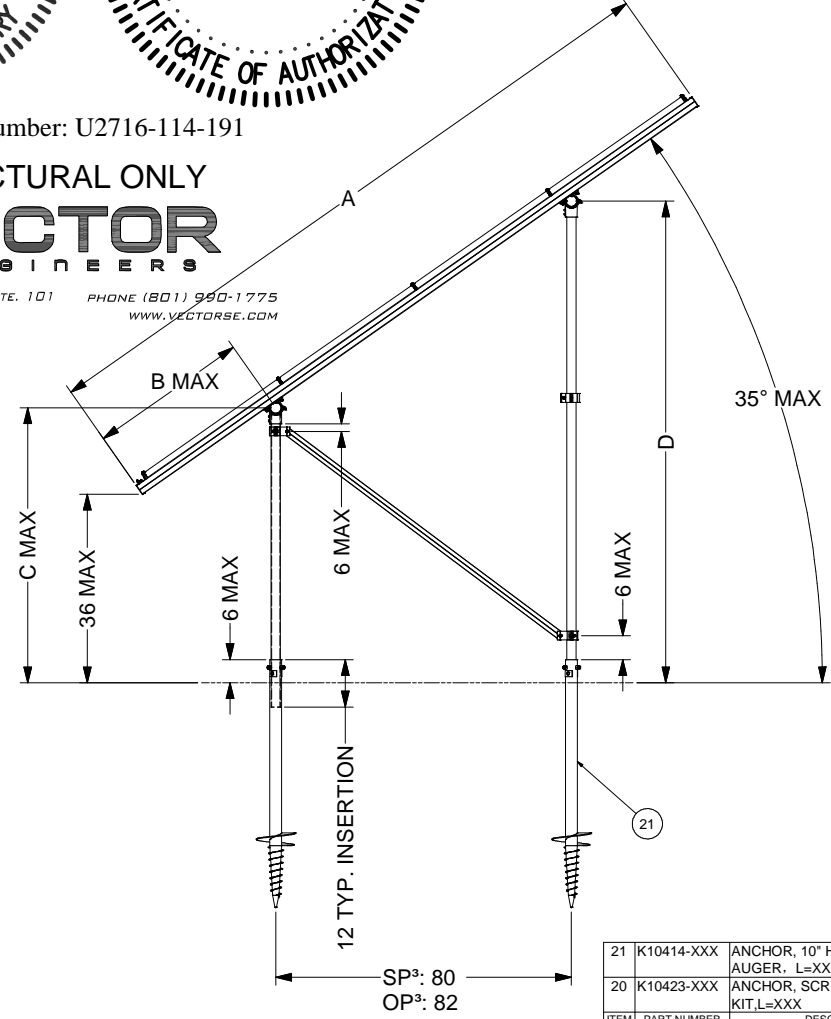

**AUGER GROUND MOUNT (AGM)**

21	K10414-XXX	ANCHOR, 10" HELIX SCREW AUGER, L=XXX	
20	K10423-XXX	ANCHOR, SCREW AUGER KIT, L=XXX	
ITEM	PART NUMBER	DESCRIPTION	QTY
<b>SunModo Corp.</b>			
TITLE: PACKET AS			
D DRAWING NUMBER			
SCALE:		SHEET 3 of 4	REV

04/22/2021

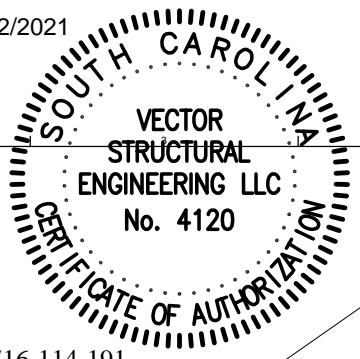
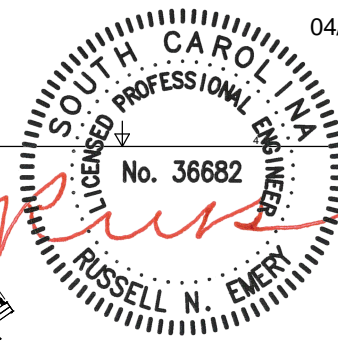

VSE Project Number: U2716-114-191



651 W. GALENA PARK BLVD. STE. 101 DRAPER, UTAH 84020 PHONE (801) 990-1775 WWW.VECTORSE.COM

DIMENSIONS - STANDARD PANEL			
ITEM	4L	2P	3L
A	172	166	130
B	37	34	16
C	55	53	43
D	111	109	99

DIMENSIONS - OVERSIZE PANEL			
ITEM	4L	2P	3L
A	184	172	140
B	42	36	20
C	58	54	45
D	115	112	103

- NOTES**
1. DIMENSIONS IN TABLE ARE SHOWN AT MAXIMUM TILT & LEADING EDGE HEIGHT. PROJECTS WITH LOWER TILTS & LEADING EDGE HEIGHTS WILL RESULT IN REDUCED DIMENSIONS.
  2. MAX DENOTES MAXIMUM PERMISSIBLE DIMENSIONS.
  3. SEE NOTE 7 OF COVER PAGE FOR PANEL SIZES.
  4. K10268-005 (2" PIPE BASE KIT) OR K10302-001 (2" PIPE BASE KIT)

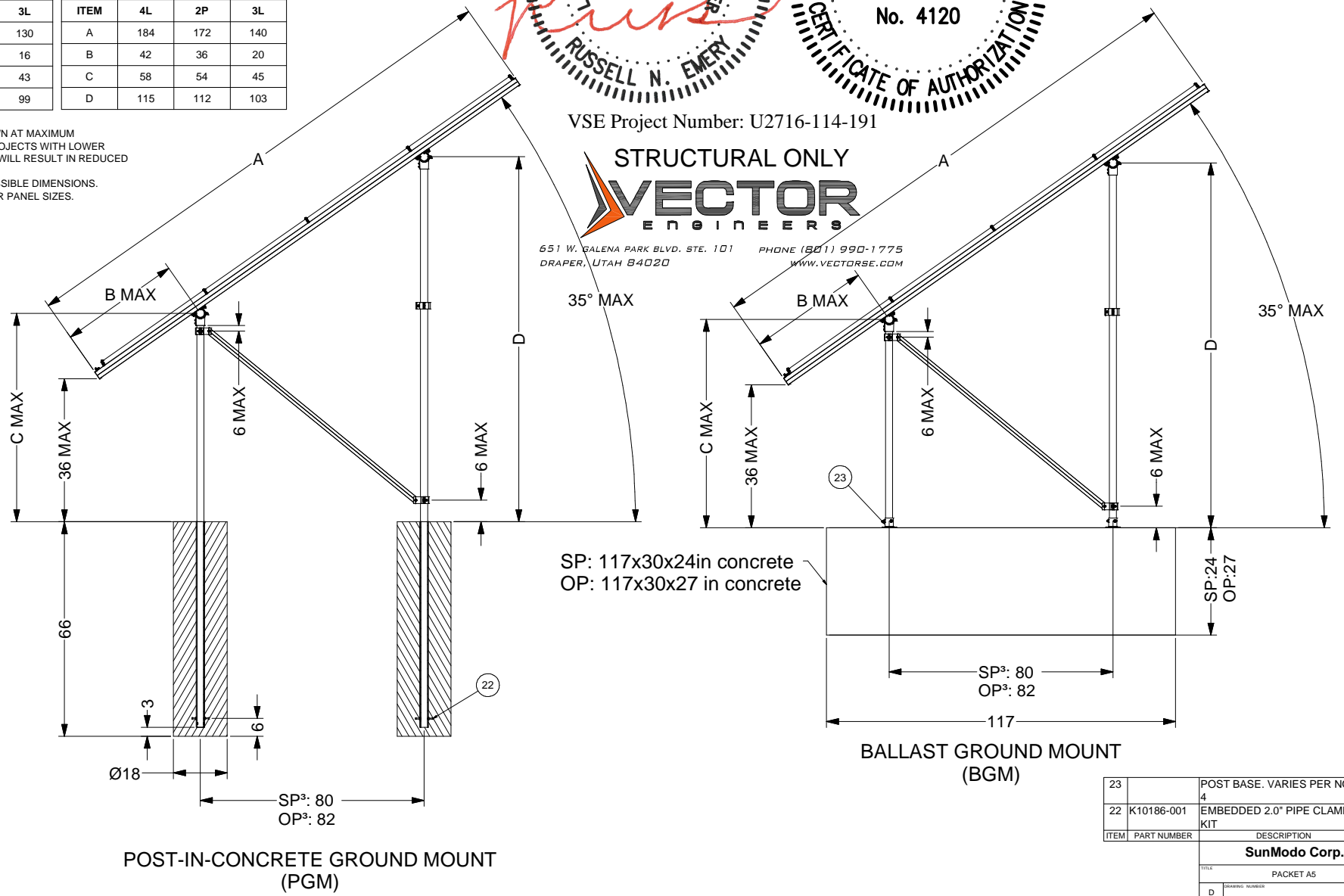

SP: 117x30x24in concrete  
OP: 117x30x27 in concrete

**BALLAST GROUND MOUNT (BGM)**

**POST-IN-CONCRETE GROUND MOUNT (PGM)**

23		POST BASE. VARIES PER NOTE	
22	K10186-001	EMBEDDED 2.0" PIPE CLAMP KIT	
ITEM	PART NUMBER	DESCRIPTION	QTY
<b>SunModo Corp.</b>			
TITLE: PACKET AS			
D DRAWING NUMBER			
SCALE:		SHEET 4 of 4	REV