

NOTES: UNLESS OTHERWISE SPECIFIED

- THIS DRAWING IS NOT FOR CONSTRUCTION UNTIL ENGINEERING HAS REVIEWED AND STAMPED THIS DOCUMENT.
- DIMENSIONS SHOWN ARE INCHES.
- THE SELF-BONDING SYSTEM AND SINGLE GROUND LUG IS FOR USE WITH PV MODULES THAT HAVE A MAXIMUM SERIES FUSE RATING OF 30A.
- MATERIALS ARE AS SPECIFIED OR EQUIVALENT:
 HARDWARE: 304 STAINLESS STEEL
 FABRICATED EXTRUDED PARTS: 6005-T5 ALUMINUM ALLOY
 FABRICATED DIE CAST PARTS: ANSI/AA A380 ALUMINUM ALLOY
 STEEL PIPE: SCHEDULE 40 GALVANIZED
 ALUMINUM PIPE: SCHEDULE 10 ANODIZED
- THE MAXIMUM PERMISSIBLE LENGTH OF ANY STRUCTURE SHALL BE 200 FT. FOR SYSTEMS USING A SHARED RAIL CONFIGURATION, A THERMAL BREAK IS REQUIRED IN THE RAIL EVERY 40 FT. PER THE DRAWING DETAILS.
- 4LXN-3LXN-2PXN-30DEG-GSM-AGM-BGM-PGM.
- PANEL DIMENSIONS ARE AS FOLLOWS
 STANDARD (SP): MAX 82"X42"
 OVERSIZE (OP): MAX 85"X45"
- APPROVED RAIL PROFILES - STANDARD PANELS
 A20144-XXX (HR250 RAIL), A20284-001 (END CAP), K10343-001 (U-CLAMP KIT);
 A20288-XXX (HR300 RAIL), A20297-001 (END CAP), K10343-002 (U-CLAMP KIT);
 A20145-XXX (HR350 RAIL), A20285-001 (END CAP), K10343-001 (U-CLAMP KIT).
- APPROVED RAIL PROFILES - OVERSIZE PANELS
 * A20288-XXX (HR300 RAIL), A20297-001 (END CAP), K10343-002 (U-CLAMP KIT);
 * A20145-XXX (HR350 RAIL), A20285-001 (END CAP), K10343-001 (U-CLAMP KIT).
- K10224-XXX END CLAMP KIT OR K10299-XXX ADJ. END CLAMP KIT.
- FOUNDATION TYPES:
 GSM = GROUND SCREW GROUND MOUNT
 AGM = HELICAL AUGER GROUND MOUNT
 PGM = POST-IN-CONCRETE GROUND MOUNT
 BSM = BALLAST GROUND MOUNT

VSE Project Number: U2716-092-191
STRUCTURAL ONLY

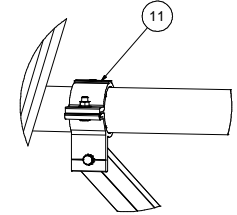
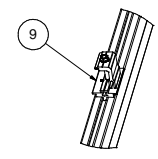
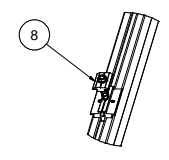
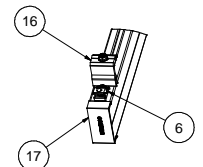
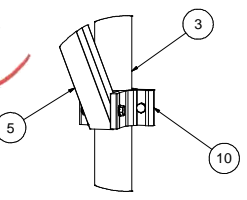
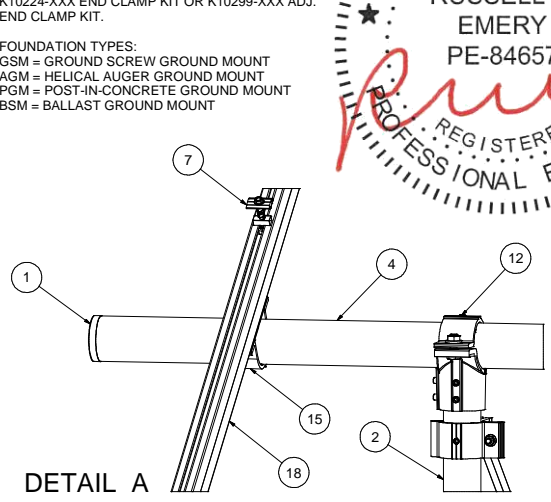
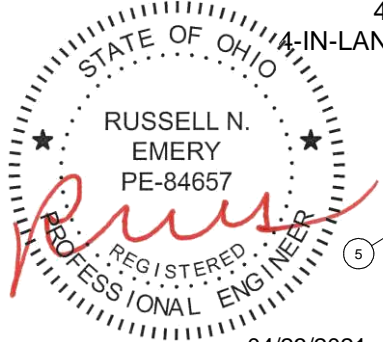
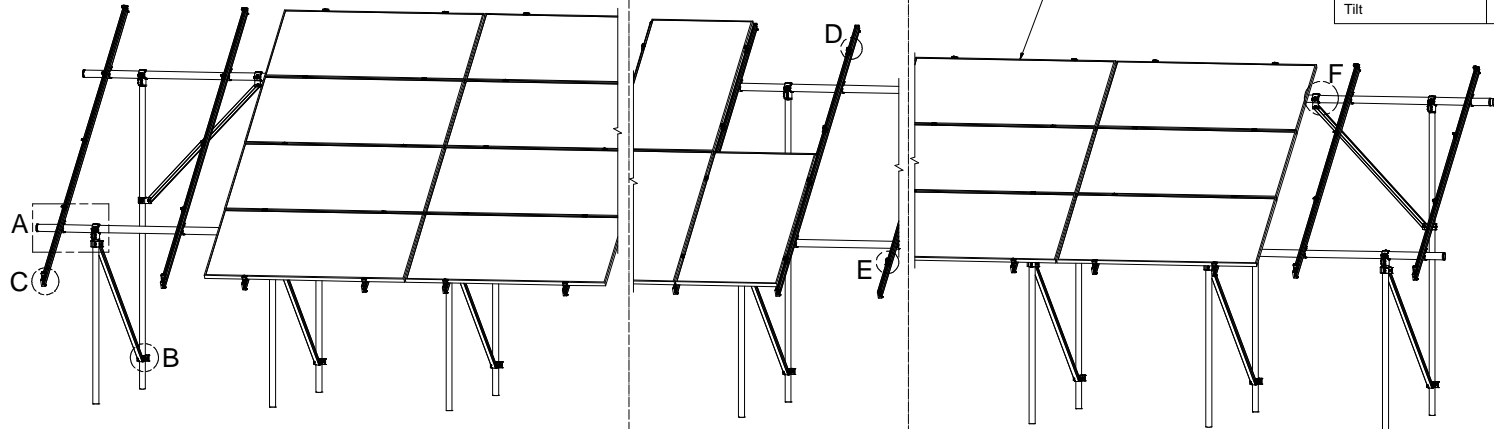

Packet B1	
Model Code	ASCE 7-10
Exposure Category	C and Lower
Wind Speed	105 mph and Lower
Ground Snow Load	30 PSF and Lower
Tilt	30 DEG and Lower

ITEM	PART NUMBER	DESCRIPTION	QTY
19		PANEL	
18		HELIO-RAIL-VARIES PER NOTE 8 & 9	
17		HELIO-RAIL END CAP-VARIES PER NOTE 8 & 9	
16		END CLAMP KIT. VARIES PER NOTE 10	
15	K10343-001	2.5" AL PIPE U-CLAMP KIT	
14	K10448-001	2.5" PIPE SPLICE KIT	
13	K10342-001	2.5" PIPE SPLICE KIT	
12	K10341-001	2.5" PIPE TEE KIT	
11	K10222-001	2.5" PIPE CLAMP KIT	
10	K10219-001	2" AL PIPE CLAMP KIT	
9	K10183-XXX	LANDSCAPE GROUNDING END CLAMP KIT	
8	K10182-001	LANDSCAPE GROUNDING MID CLAMP KIT	
7	K10180-001	GROUNDING MID-CLAMP KIT WITH T COLLAR BOLT AND GROUNDING BASE	
6	K10179-001	SELF-GROUNDING LUG KIT	
5	A50164-XXX	1.5" SQ. STL TUBE BRACE, L=XXX	
4	A21168-XXX	PIPE, HSS, 2.875" OD X 12 GAUGE, L=XXX	
3	A21165-XXX	PIPE, HSS, 2.375" OD X 12 GAUGE, L=XXX	
2	A21165-XXX	PIPE, HSS, 2.375" OD X 12 GAUGE, L=XXX	
1	A20380-001	2.5" PIPE END CAP	

SEE BOM
 Third Angle Projection
 PERSONAL USE ONLY (Not for Redistribution)
 SunModo Corp.
 14800 NE 65TH STREET, VANCOUVER WA 98662
 TITLE: PACKET B1
 DRAWING NUMBER: D
 DATE: 04/21/2021
 CHECKED BY: KVV
 APPROVALS: [Signature]
 SCALE: SHEET 1 of 4

NOTES:

- 1. DIMENSIONS LABELED AS MAX ARE MAXIMUM ALLOWABLE AND MAY RESULT IN END POSTS BEING OUTSIDE ARRAY EDGES. MAXIMUM DIMENSIONS MAY BE REDUCED IF DESIRED.
- 2. SEE NOTE 7 OF COVER PAGE FOR PANEL SIZES.

RAIL SPACING

LANDSCAPE: PER PANEL MANUFACTURER
PORTRAIT: PANEL WIDTH + 0.25"

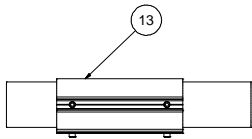

DETAIL G

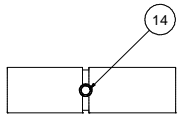

DETAIL H
(ALTERNATE)

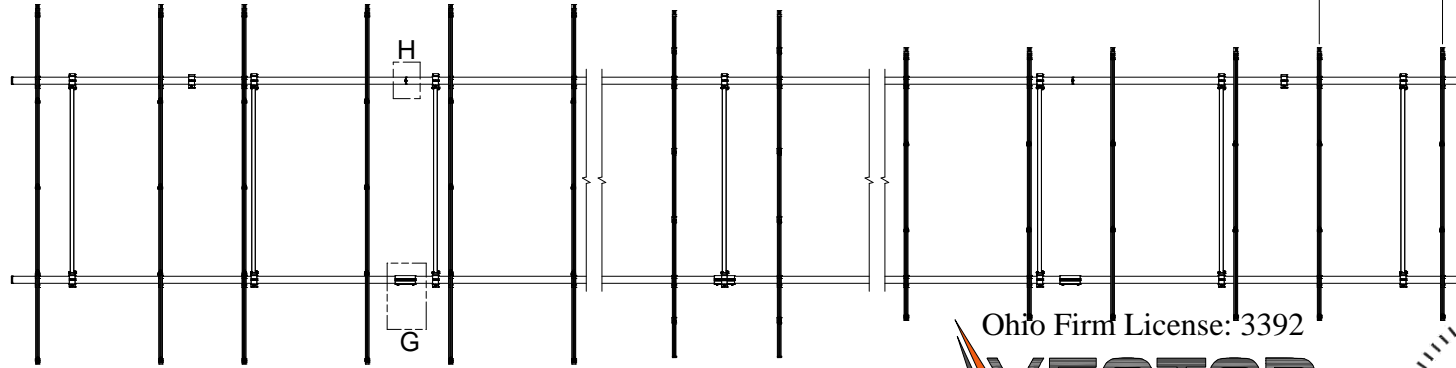

Ohio Firm License: 3392
VECTOR
ENGINEERS

651 W. GALENA PARK BLVD. STE. 101 PHONE (801) 990-1775
DRAPER, UTAH 84020 WWW.VECTORSE.COM

VSE Project Number: U2716-092-191

STRUCTURAL ONLY



04/23/2021

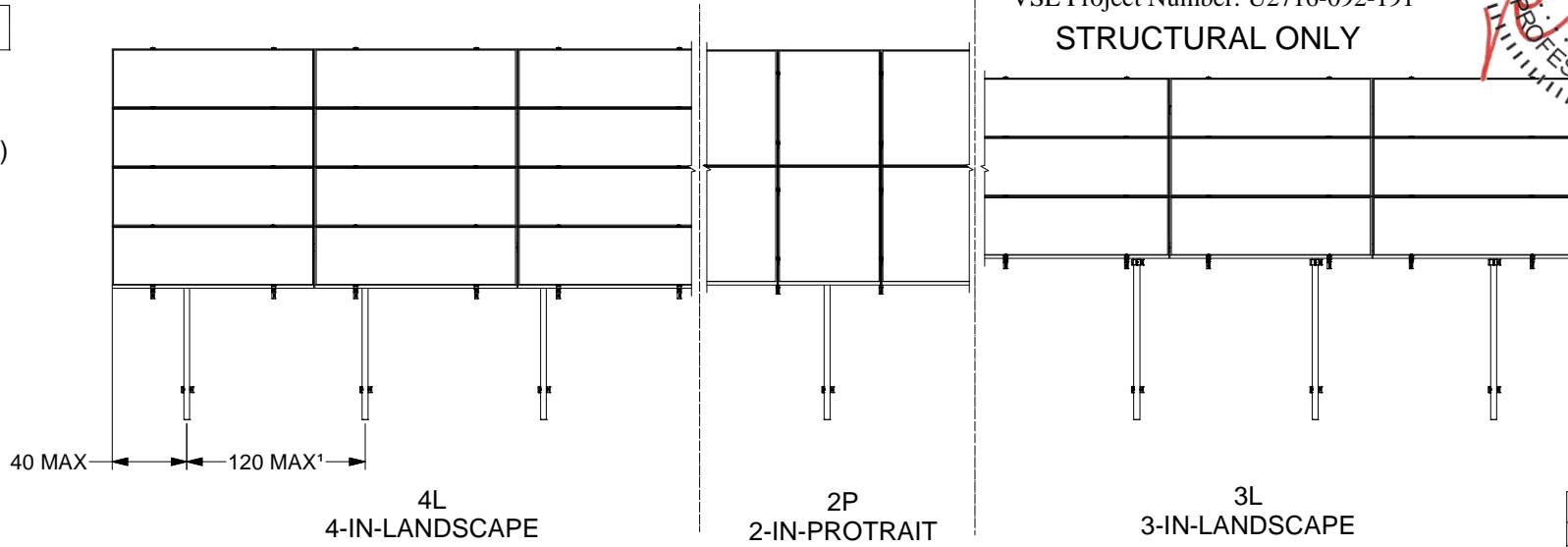

4L
4-IN-LANDSCAPE

2P
2-IN-PORTRAIT

3L
3-IN-LANDSCAPE

SunModo Corp.	
TITLE	PACKET B1
D	DRAWING NUMBER
SCALE:	SHEET 2 of 4 REV

DIMENSIONS - STANDARD PANEL			
ITEM	4L	2P	3L
A	172	166	130
B	37	34	16
C	52	50	41
D	101	100	91

DIMENSIONS - OVERSIZE PANEL			
ITEM	4L	2P	3L
A	184	172	140
B	41	35	19
C	54	51	43
D	105	102	94

- NOTES**
1. DIMENSIONS IN TABLE ARE SHOWN AT MAXIMUM TILT & LEADING EDGE HEIGHT. PROJECTS WITH LOWER TILTS & LEADING EDGE HEIGHTS WILL RESULT IN REDUCED DIMENSIONS.
 2. MAX DENOTES MAXIMUM PERMISSIBLE DIMENSIONS.
 3. SEE NOTE 7 OF COVER PAGE FOR PANEL SIZES.

Ohio Firm License: 3392



651 W. GALENA PARK BLVD. STE. 101 DRAPER, UTAH 84020
PHONE (801) 990-1775 WWW.VECTORSE.COM

VSE Project Number: U2716-092-191

STRUCTURAL ONLY



04/23/2021

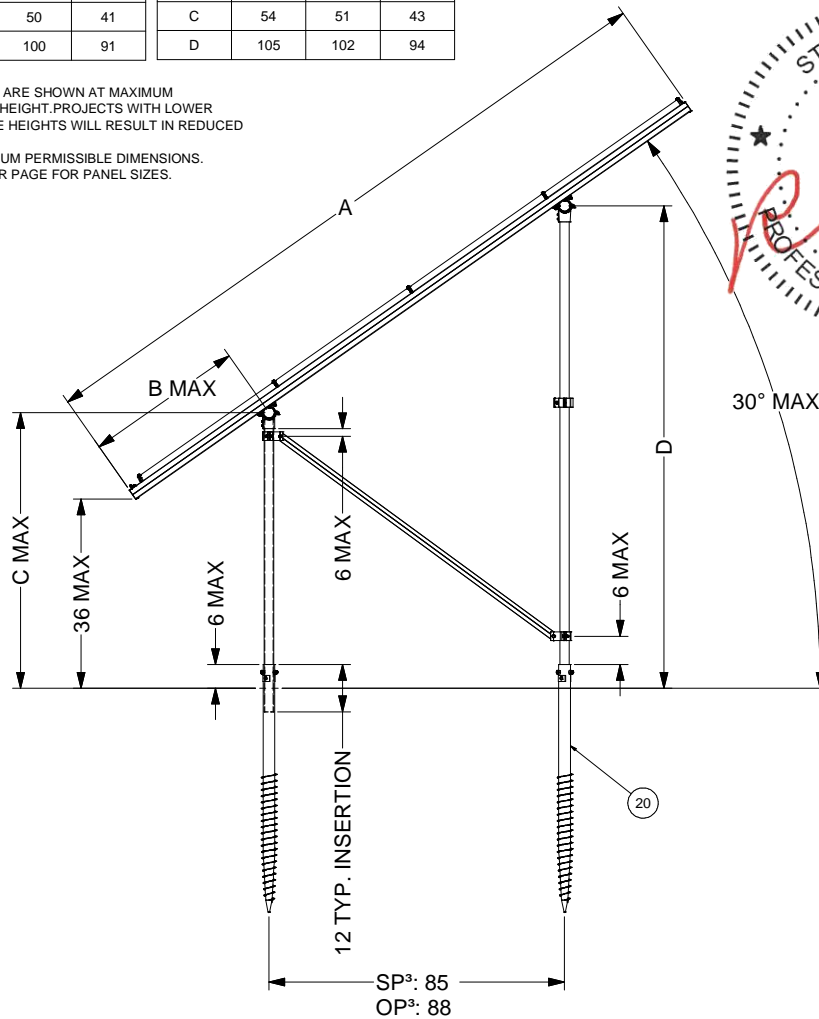

GROUND SCREW GROUND MOUNT (GSM)

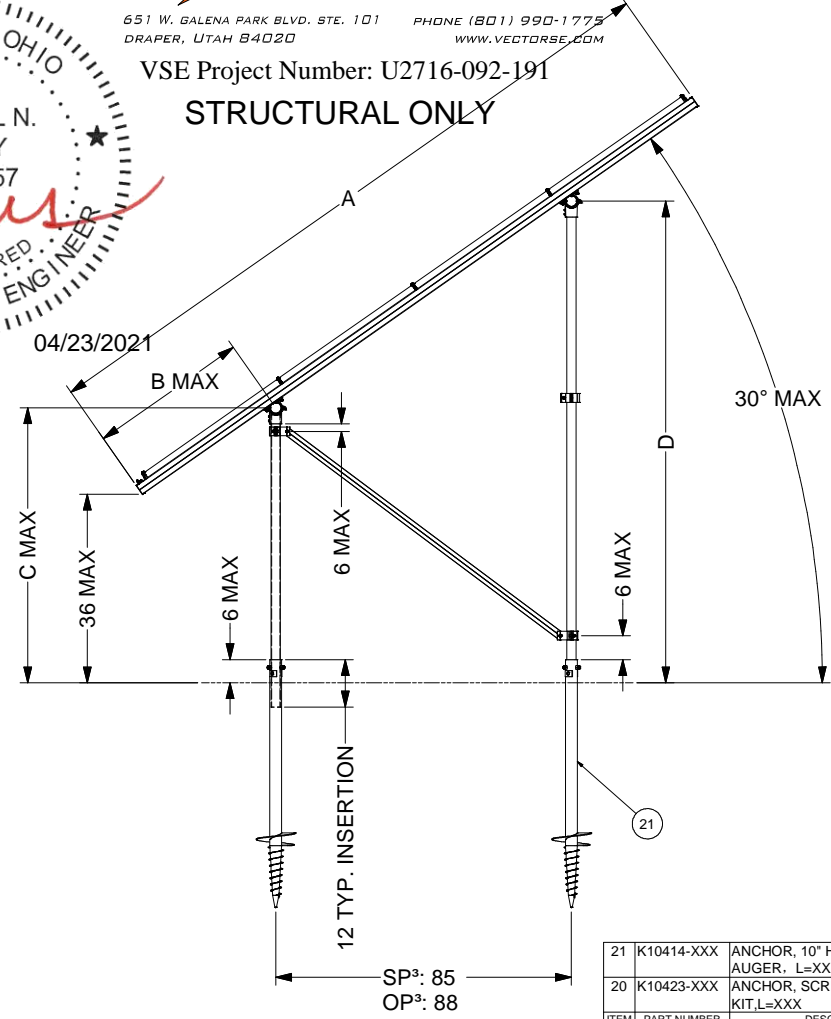

AUGER GROUND MOUNT (AGM)

21	K10414-XXX	ANCHOR, 10" HELIX SCREW AUGER, L=XXX	
20	K10423-XXX	ANCHOR, SCREW AUGER KIT, L=XXX	
ITEM	PART NUMBER	DESCRIPTION	QTY
SunModo Corp.			
TITLE: PACKET B1			
DRAWING NUMBER: D			
SCALE:		SHEET 3 of 4	REV

VSE Project Number: U2716-092-191
STRUCTURAL ONLY

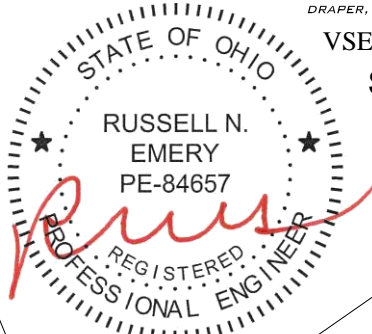

04/23/2021

DIMENSIONS - STANDARD PANEL			
ITEM	4L	2P	3L
A	172	166	130
B	37	34	16
C	52	50	41
D	101	100	91

DIMENSIONS - OVERSIZE PANEL			
ITEM	4L	2P	3L
A	184	172	140
B	41	35	19
C	54	51	43
D	105	102	94

- NOTES**
1. DIMENSIONS IN TABLE ARE SHOWN AT MAXIMUM TILT & LEADING EDGE HEIGHT. PROJECTS WITH LOWER TILTS & LEADING EDGE HEIGHTS WILL RESULT IN REDUCED DIMENSIONS.
 2. MAX DENOTES MAXIMUM PERMISSIBLE DIMENSIONS.
 3. SEE NOTE 7 OF COVER PAGE FOR PANEL SIZES.
 4. K10268-005 (2" PIPE BASE KIT) OR K10302-001 (2" PIPE BASE KIT)

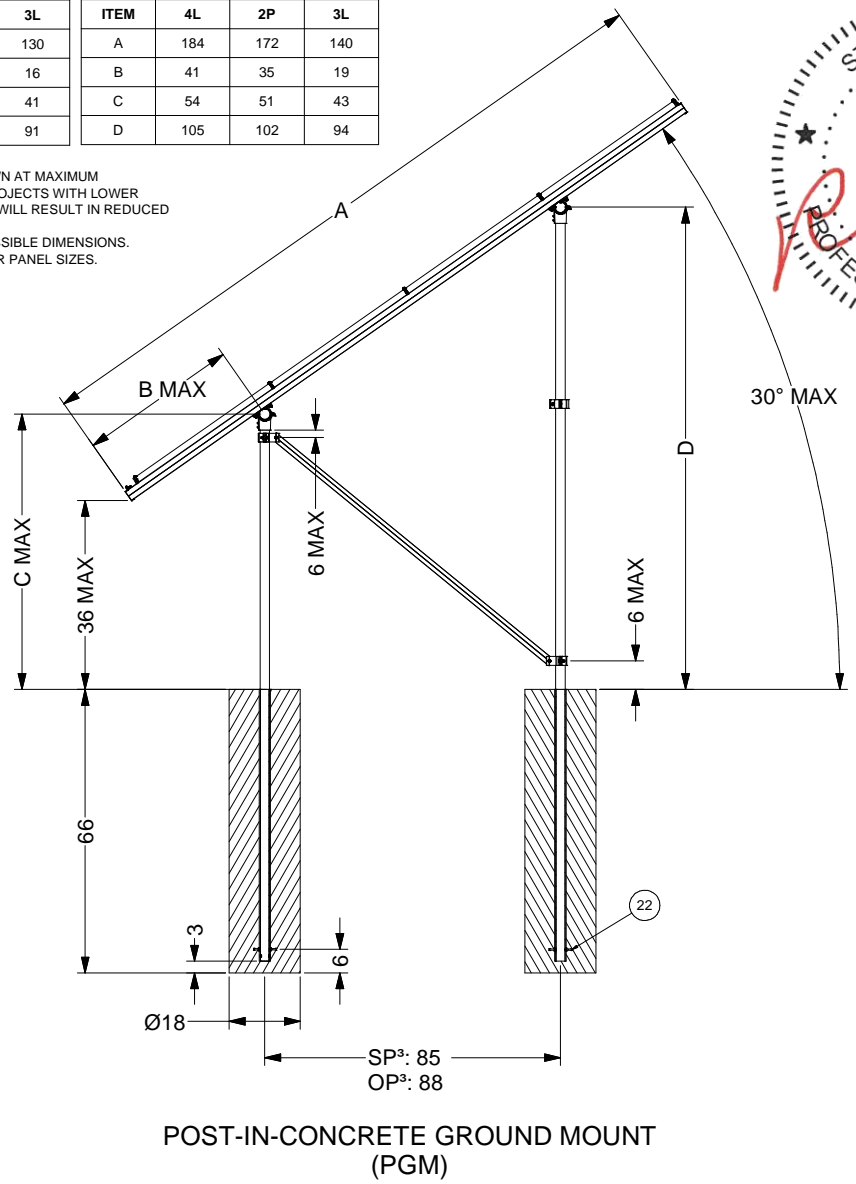

POST-IN-CONCRETE GROUND MOUNT (PGM)

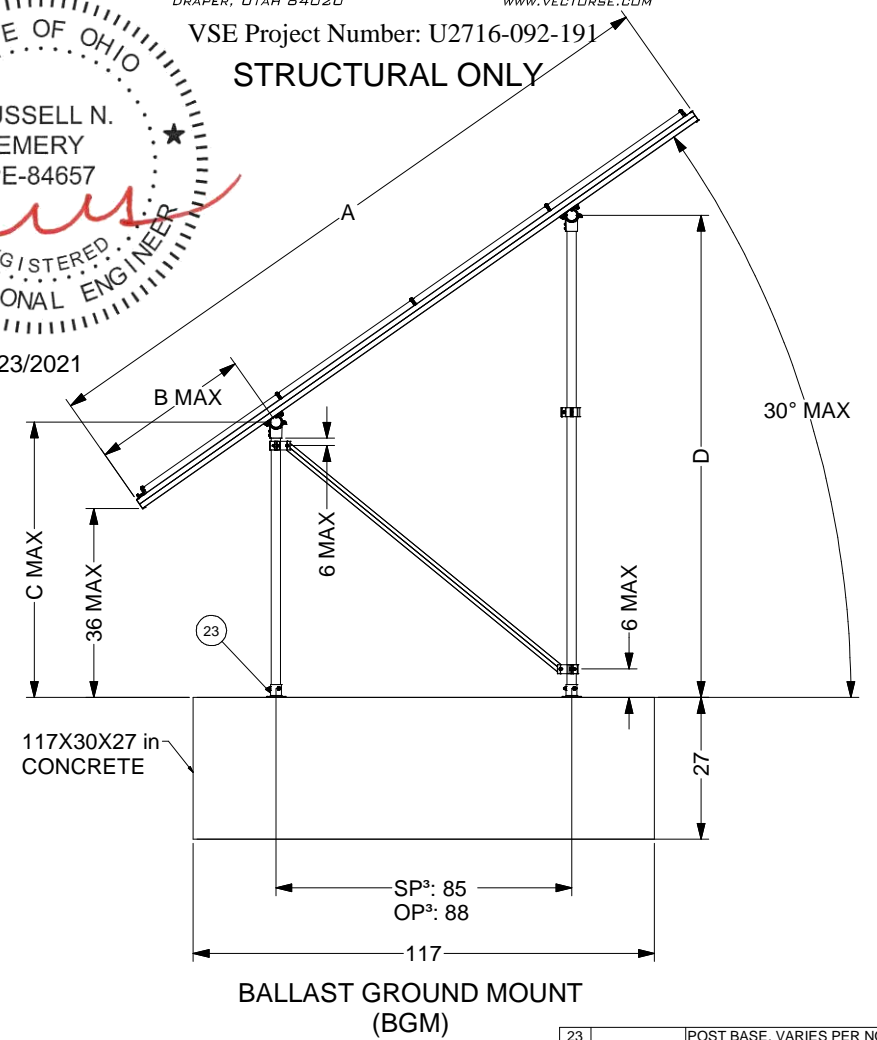

BALLAST GROUND MOUNT (BGM)

23		POST BASE. VARIES PER NOTE	
22	K10186-001	EMBEDDED 2.0" PIPE CLAMP KIT	
ITEM	PART NUMBER	DESCRIPTION	QTY
SunModo Corp.			
TITLE: PACKET B1			
DRAWING NUMBER: D			
SCALE:		SHEET 4 of 4	REV