

VSE Project Number: U2716-099-191

STRUCTURAL ONLY



651 W. GALENA PARK BLVD. STE. 101 DRAPER, UTAH 84020
 PHONE (801) 990-1775
 WWW.VECTORSE.COM

NOTES: UNLESS OTHERWISE SPECIFIED

- THIS DRAWING IS NOT FOR CONSTRUCTION UNTIL ENGINEERING HAS REVIEWED AND STAMPED THIS DOCUMENT.
- DIMENSIONS SHOWN ARE INCHES.
- THE SELF-BONDING SYSTEM AND SINGLE GROUND LUG IS FOR USE WITH PV MODULES THAT HAVE A MAXIMUM SERIES FUSE RATING OF 30A.
- MATERIALS ARE AS SPECIFIED OR EQUIVALENT:
 HARDWARE: 304 STAINLESS STEEL
 FABRICATED EXTRUDED PARTS: 6005-T5 ALUMINUM ALLOY
 FABRICATED DIE CAST PARTS: ANSI/AA A380 ALUMINUM ALLOY
 STEEL PIPE: SCHEDULE 40 GALVANIZED
 ALUMINUM PIPE: SCHEDULE 10 ANODIZED
- THE MAXIMUM PERMISSIBLE LENGTH OF ANY STRUCTURE SHALL BE 200 FT. FOR SYSTEMS USING A SHARED RAIL CONFIGURATION, A THERMAL BREAK IS REQUIRED IN THE RAIL EVERY 40 FT. PER THE DRAWING DETAILS.
- 4LXN-3LXN-2PXN-30DEG-GSM-AGM-BGM-PGM.
- PANEL DIMENSIONS ARE AS FOLLOWS
 STANDARD (SP): MAX 82"X42"
 OVERSIZE (OP): MAX 85"X45"
- APPROVED RAIL PROFILES - STANDARD PANELS
 A20288-XXX (HR300 RAIL), A20297-001 (END CAP), K10343-002 (U-CLAMP KIT),
 A20145-XXX (HR350 RAIL), A20285-001 (END CAP), K10343-001 (U-CLAMP KIT),
 A20144-XXX(HR250 RAIL),A20284-001(END CAP), K10343-001(U-CLAMP KIT)
- APPROVED RAIL PROFILES - OVERSIZE PANELS
 * A20288-XXX (HR300 RAIL), A20297-001 (END CAP), K10343-002 (U-CLAMP KIT);
 * A20145-XXX (HR350 RAIL), A20285-001 (END CAP), K10343-001 (U-CLAMP KIT);
 * A20144-XXX(HR250 RAIL),A20284-001(END CAP), K10343-001(U-CLAMP KIT)
- K10224-XXX END CLAMP KIT OR K10299-XXX ADJ. END CLAMP KIT.
- FOUNDATION TYPES:
 GSM = GROUND SCREW GROUND MOUNT
 AGM = HELICAL AUGER GROUND MOUNT
 PGM = POST-IN-CONCRETE GROUND MOUNT
 BSM = BALLAST GROUND MOUNT

Packet C3	
Model Code	ASCE 7-16
Exposure Category	C and Lower
Wind Speed	100 mph and Lower
Ground Snow Load	0 PSF and Lower
Tilt	30 DEG and Lower

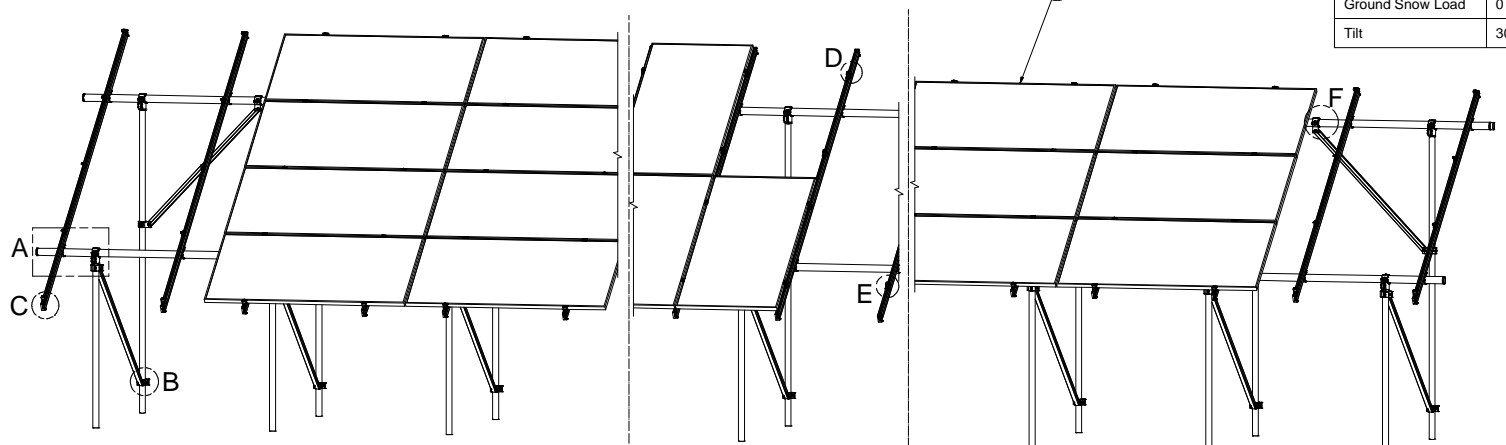

4L 4-IN-LANDSCAPE
 2P 2-IN-PROTRAIT
 3L 3-IN-LANDSCAPE
 STANDARD PANEL (SP) ONLY

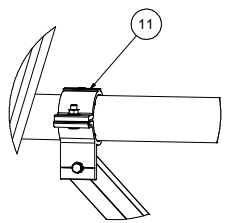
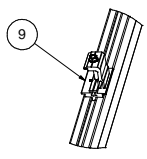
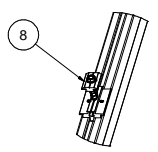
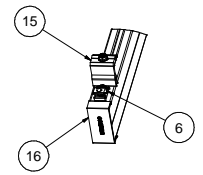
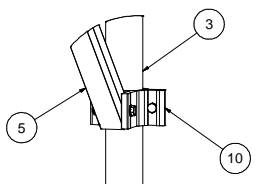
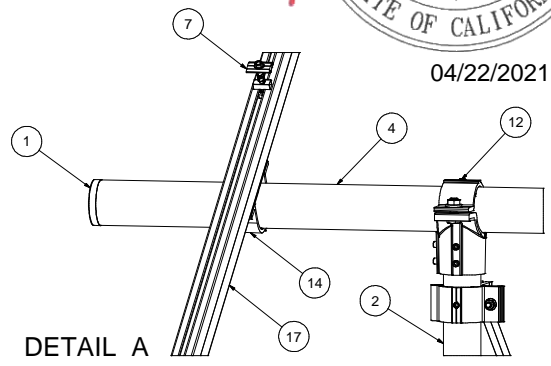
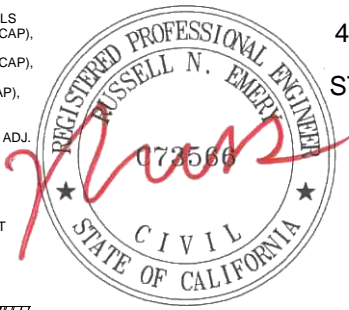

ITEM	PART NUMBER	DESCRIPTION	QTY
19	K10448-001	2.5" PIPE SPLICE KIT	3
18		PANEL	
17		HELIO RAIL.VARIES PER NOTE 8 & 9	
16		HELIO RAIL END CAP.VARIES PER NOTE 8 & 9	
15		END CLAMP KIT. VARIES PER NOTE 10	
14	K10343-001	2.5" AL PIPE U-CLAMP KIT	
13	K10342-001	2.5" PIPE SPLICE KIT	
12	K10341-001	2.5" PIPE TEE KIT	
11	K10222-001	2.5" PIPE CLAMP KIT	
10	K10219-001	2" AL PIPE CLAMP KIT	
9	K10183-XXX	LANDSCAPE GROUNDING END CLAMP KIT	
8	K10182-001	LANDSCAPE GROUNDING MID CLAMP KIT	
7	K10180-001	GROUNDING MID-CLAMP KIT WITH T COLLAR BOLT AND GROUNDING BASE	
6	K10179-001	SELF-GROUNDING LUG KIT	
5	A50164-XXX	1.5" SQ. STL TUBE BRACE, L=XXX	
4	A21168-XXX	PIPE, HSS, 2.875" OD X 12 GAUGE, L=XXX	
3	A21165-XXX (REAR)	PIPE, HSS, 2.375" OD X 12 GAUGE, L=XXX	
2	A21165-XXX (FRONT)	PIPE, HSS, 2.375" OD X 12 GAUGE, L=XXX	
1	A20380-001	2.5" PIPE END CAP	

SEE BOM
 Third Angle Projection
 PERSONAL USE ONLY (Not for Redistribution)
 SunModo Corp.
 14800 NE 65TH STREET, VANCOUVER WA 98682
 TITLE: PACKET C3
 DRAWING NUMBER: D
 DATE: 04/21/2021
 CHECKED BY: KVV
 APPROVALS: [Signature]
 SCALE: SHEET 1 of 4

THIS DRAWING IS CONFIDENTIAL PROPERTY OF SUNMODO AND ITS CONTENTS MAY NOT BE DISCLOSED WITHOUT THE PRIOR WRITTEN CONSENT OF SUNMODO CORP.

- NOTES:**
 1. DIMENSIONS LABELED AS MAX ARE MAXIMUM ALLOWABLE
 AND MAY RESULT IN END POSTS BEING OUTSIDE ARRAY EDGES.
 MAXIMUM DIMENSIONS MAY BE REDUCED IF DESIRED.
 2. SEE NOTE 7 OF COVER PAGE FOR PANEL SIZES.

RAIL SPACING
 LANDSCAPE: PER PANEL MANUFACTURER
 PORTRAIT: PANEL WIDTH + 0.25"

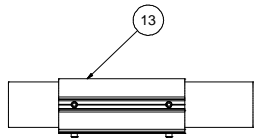

DETAIL G

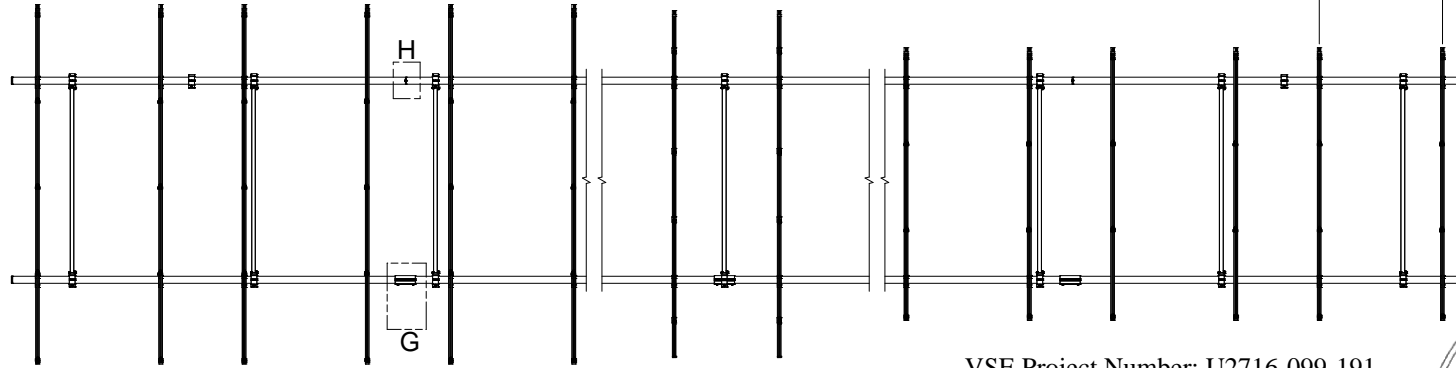

VSE Project Number: U2716-099-191



651 W. GALENA PARK BLVD. STE. 101 DRAPER, UTAH 84020
 PHONE (801) 990-1775 WWW.VECTORSE.COM



04/22/2021

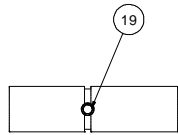

DETAIL H (ALTERNATE)

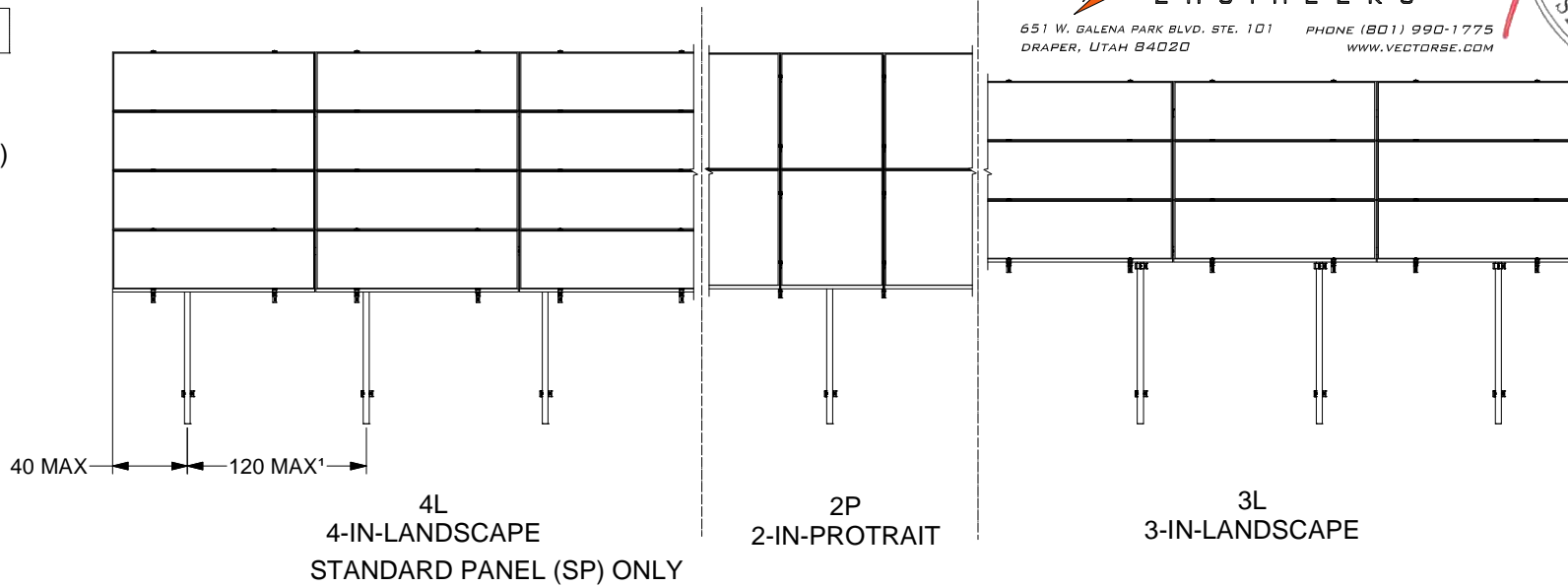

SunModo Corp.	
TITLE	PACKET C3
D	DRAWING NUMBER
SCALE:	SHEET 2 of 4 REV

STRUCTURAL ONLY



651 W. GALENA PARK BLVD. STE. 101 DRAPER, UTAH 84020
 PHONE (801) 990-1775
 WWW.VECTORSE.COM



04/22/2021

DIMENSIONS - STANDARD PANEL				DIMENSIONS - OVERSIZE PANEL			
ITEM	4L	2P	3L	ITEM	4L	2P	3L
A	172	166	130	A	184	172	140
B	39	36	18	B	40	34	18
C	65	64	55	C	60	57	49
D	112	110	101	D	111	108	100

NOTES

1. DIMENSIONS IN TABLE ARE SHOWN AT MAXIMUM TILT & LEADING EDGE HEIGHT. PROJECTS WITH LOWER TILTS & LEADING EDGE HEIGHTS WILL RESULT IN REDUCED DIMENSIONS.
2. MAX DENOTES MAXIMUM PERMISSIBLE DIMENSIONS.
3. SEE NOTE 7 OF COVER PAGE FOR PANEL SIZES.

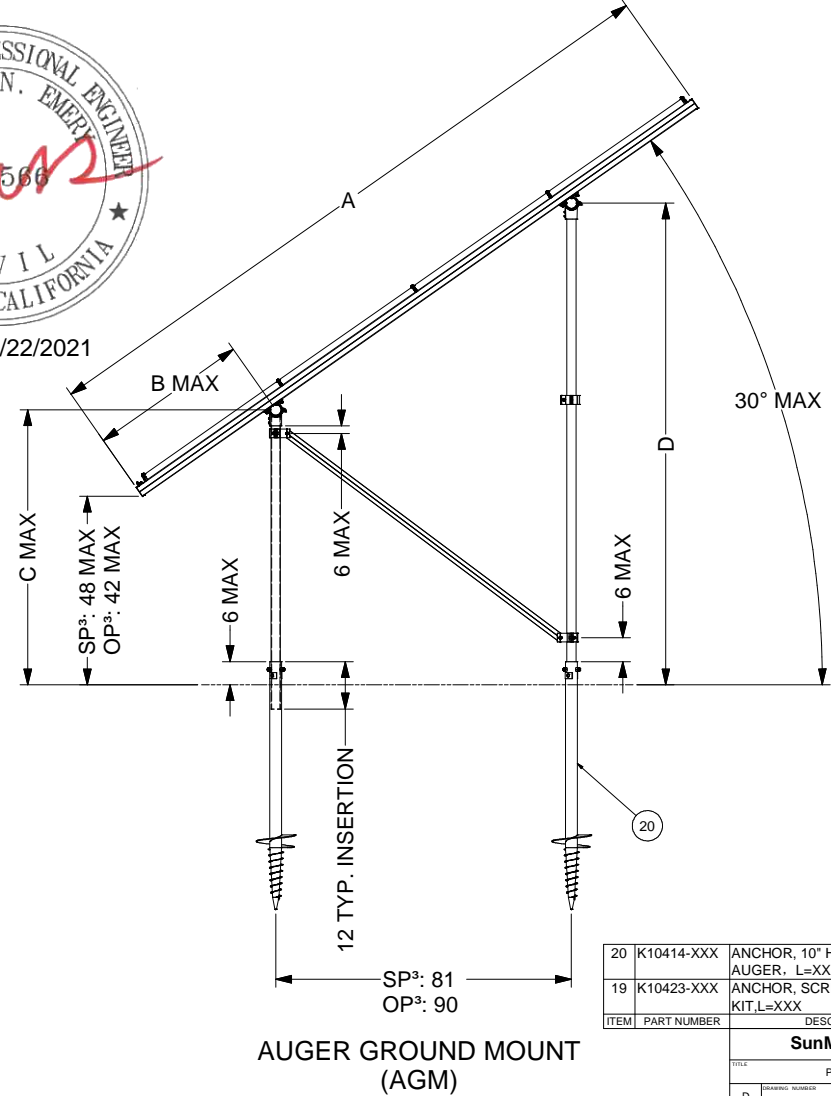
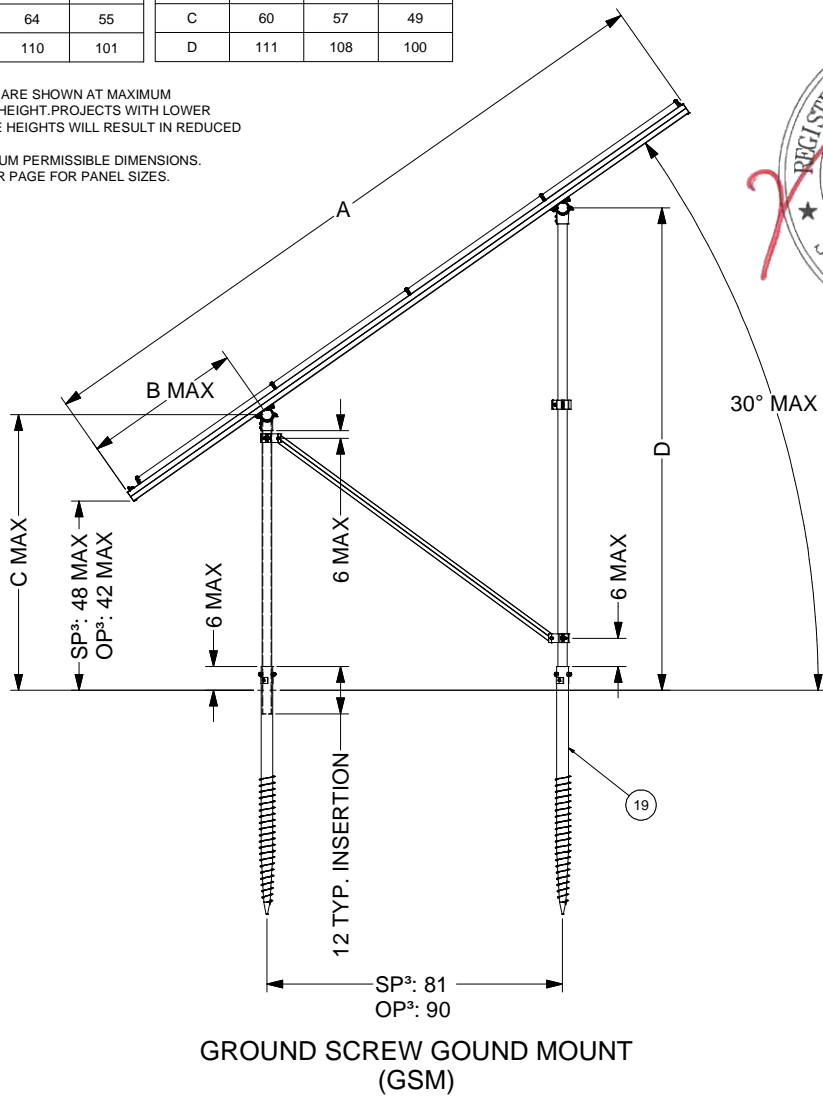

20	K10414-XXX	ANCHOR, 10" HELIX SCREW AUGER, L=XXX	
19	K10423-XXX	ANCHOR, SCREW AUGER KIT, L=XXX	
ITEM	PART NUMBER	DESCRIPTION	QTY
SunModo Corp.			
TITLE: PACKET C3			
D DRAWING NUMBER			
SCALE:		SHEET 3 of 4	REV

