

**PLAN VIEW**

**SMR SYSTEM CORRUGATED METAL ROOF MOUNT, PORTRAIT MODULE**

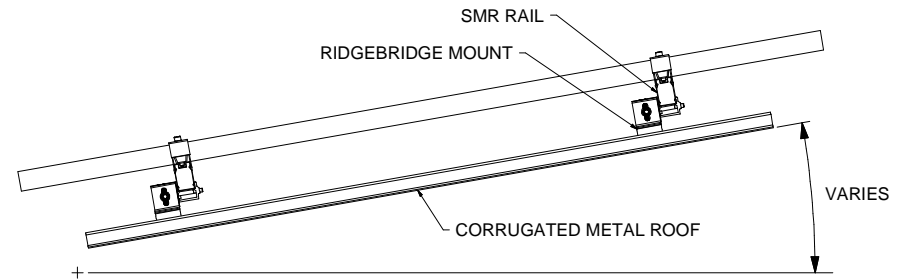

**SIDE VIEW**

**SMR SYSTEM CORRUGATED METAL MOUNT, PORTRAIT MODULE**

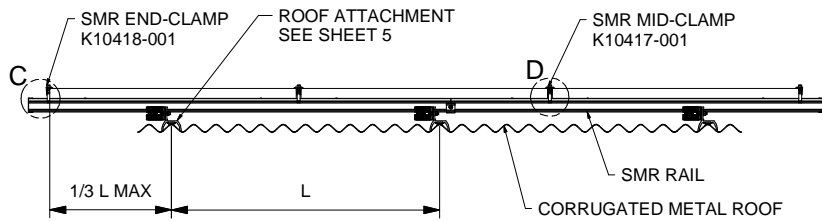

**FRONT VIEW**

**SMR SYSTEM CORRUGATED METAL ROOF MOUNT, PORTRAIT MODULE**

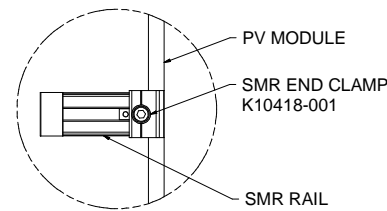

**DETAIL A**

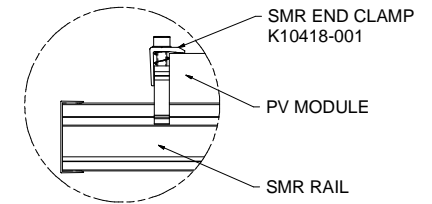

**DETAIL C**

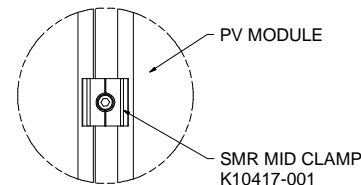

**DETAIL B**

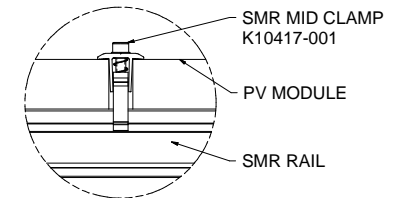

**DETAIL D**

<b>SunModo Corp.</b>	
TITLE SMR PITCHED ROOF SYSTEM	
D	DRAWING NUMBER D10246-V001
SCALE:	SHEET 1 of 5 REV

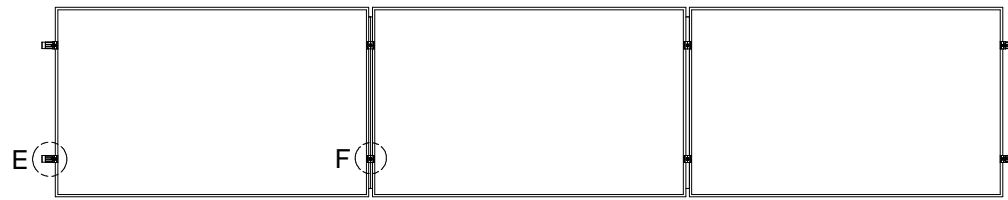

**PLAN VIEW**  
**SMR SYSTEM CORRUGATED METAL ROOF MOUNT, LANDSCAPE MODULE**

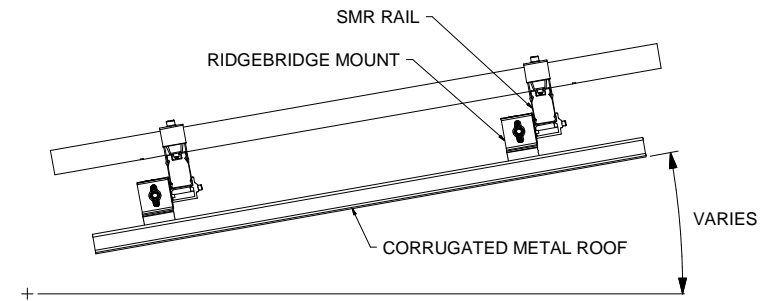

**SIDE VIEW**  
**SMR SYSTEM CORRUGATED METAL ROOF MOUNT, LANDSCAPE MODULE**

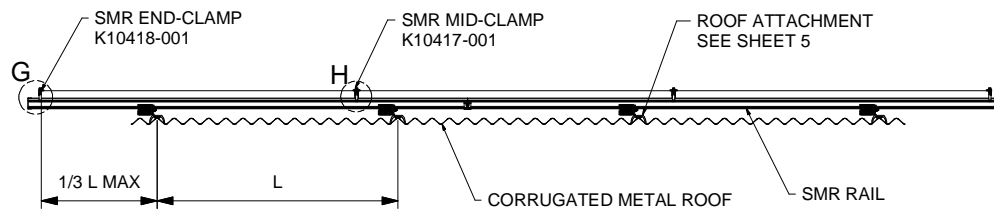

**FRONT VIEW**  
**SMR SYSTEM CORRUGATED METAL ROOF MOUNT, LANDSCAPE MODULE**

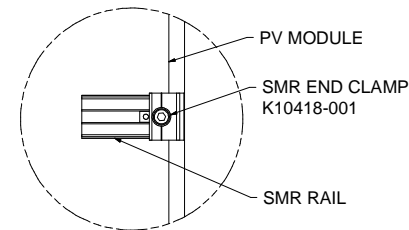

**DETAIL E**

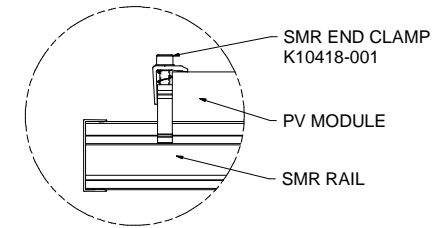

**DETAIL G**

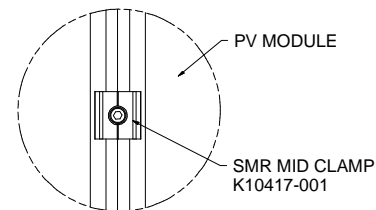

**DETAIL F**

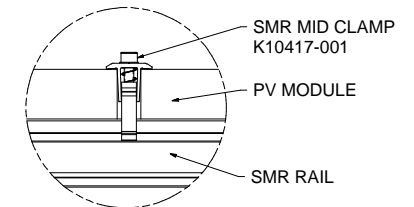

**DETAIL H**

<b>SunModo Corp.</b>	
TITLE SMR PITCHED ROOF SYSTEM	
D	DRAWING NUMBER D10246-V001
SCALE:	SHEET 2 of 5 REV

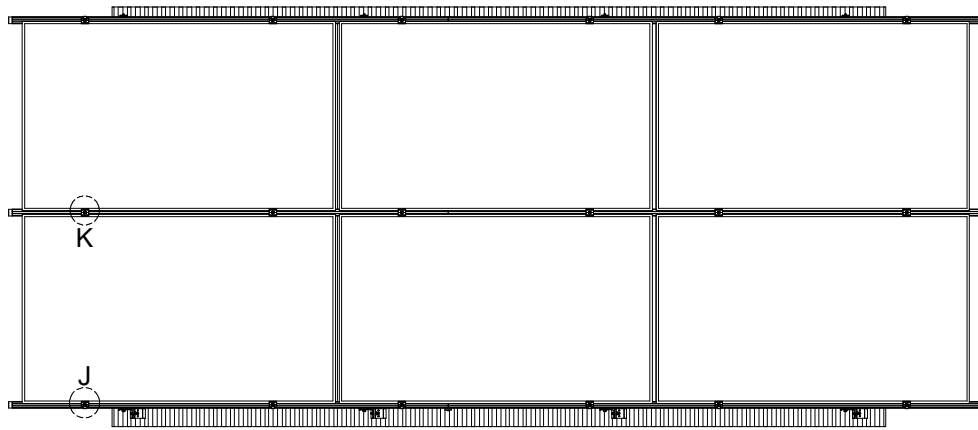

**PLAN VIEW, SMR SYSTEM CORRUGATED METAL ROOF MOUNT,  
SHARED RAIL, LANDSCAPE MODULE**

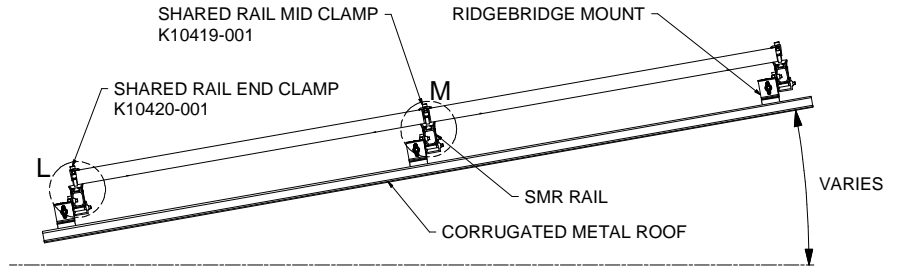

**SIDE VIEW, SMR SYSTEM CORRUGATED METAL ROOF MOUNT,  
SHARED RAIL, LANDSCAPE MODULE**

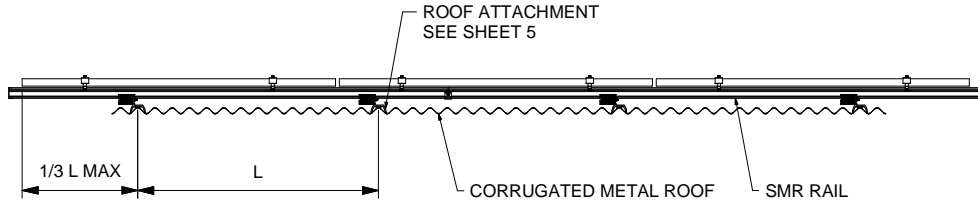

**FRONT VIEW, SMR SYSTEM CORRUGATED METAL ROOF MOUNT,  
SHARED RAIL, LANDSCAPE MODULE**

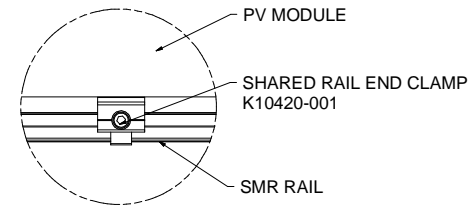

**DETAIL J**

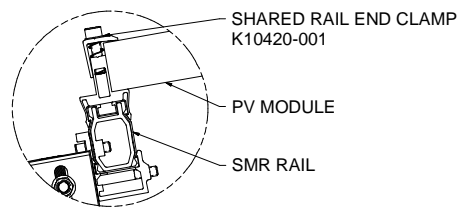

**DETAIL L**

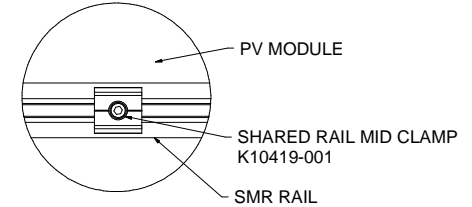

**DETAIL K**

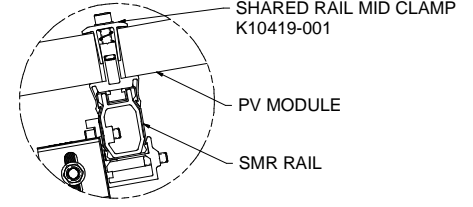

**DETAIL M**

<b>SunModo Corp.</b>	
TITLE SMR PITCHED ROOF SYSTEM	
D	DRAWING NUMBER D10246-V001
SCALE:	SHEET 3 of 5 REV

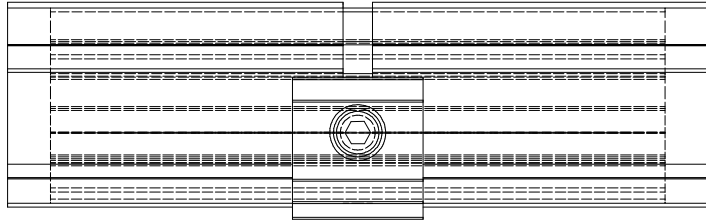

DETAIL, SPLICE CONNECTION, SMR RAIL

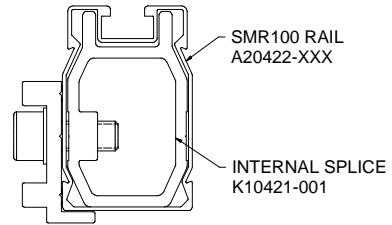

DETAIL, SPLICE, SMR100

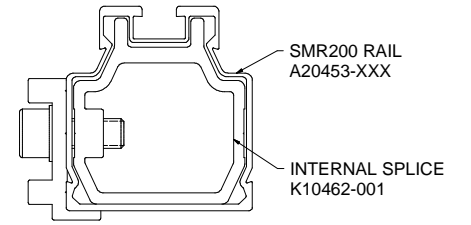

DETAIL, SPLICE, SMR200

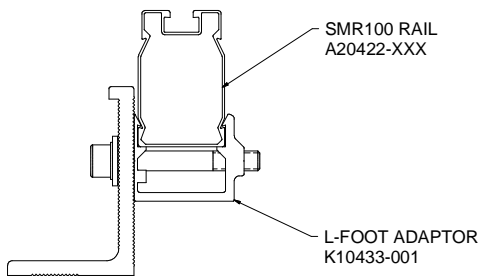

DETAIL, L-FOOT ADAPTOR, SMR100

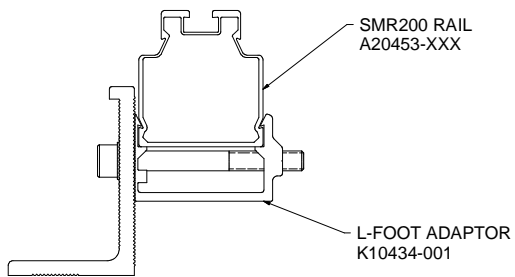

DETAIL, L-FOOT ADAPTOR, SMR200

<b>SunModo Corp.</b>			
TITLE SMR PITCHED ROOF SYSTEM			
DRAWING NUMBER: D10246-V001			
D	SHEET	4	of 5
SCALE:		REV	1

# CORRUGATED METAL ROOF ATTACHMENT OPTIONS

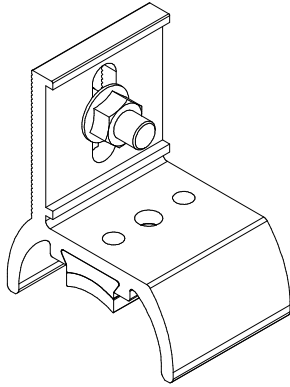

3/4 Pitch Height RidgeBridge Mount (no lag bolt)  
K10211-002

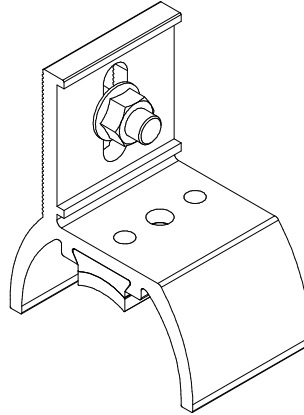

1 Pitch Height RidgeBridge Mount (no lag bolt)  
K10212-002

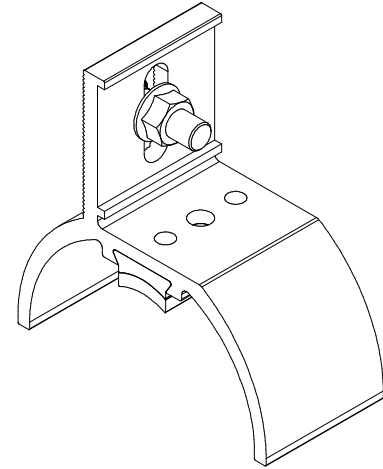

1-1/2 Pitch Height RidgeBridge Mount (no lag bolt)  
K10213-002

<b>SunModo Corp.</b>	
TITLE SMR PITCHED ROOF SYSTEM	
D	DRAWING NUMBER D10246-V001
SCALE:	SHEET 5 of 5 REV 1