

**PLAN VIEW**  
**SMR SYSTEM TRAPEZOIDAL METAL ROOF MOUNT, PORTRAIT MODULE**

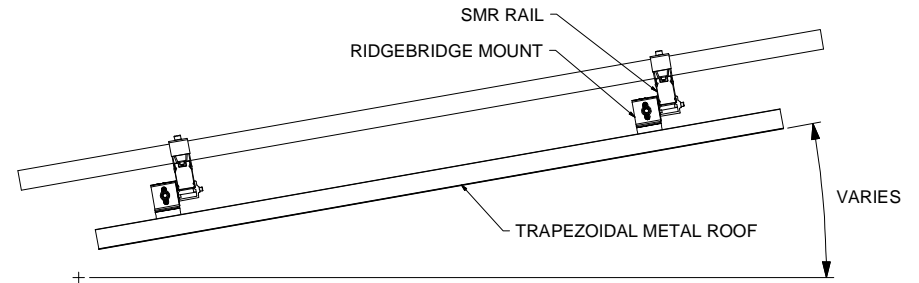

**SIDE VIEW**  
**SMR SYSTEM TRAPEZOIDAL METAL MOUNT, PORTRAIT MODULE**

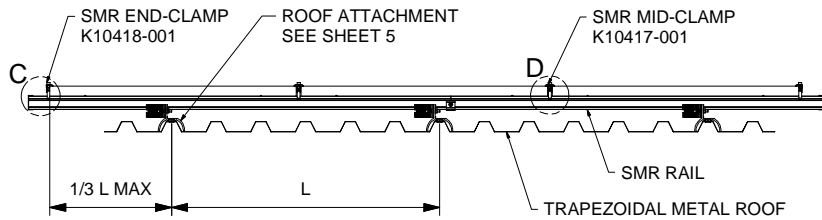

**FRONT VIEW**  
**SMR SYSTEM TRAPEZOIDAL METAL ROOF MOUNT, PORTRAIT MODULE**

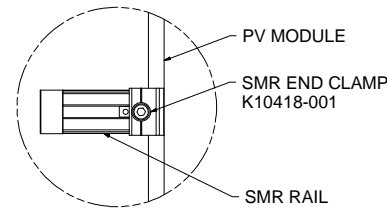

**DETAIL A**

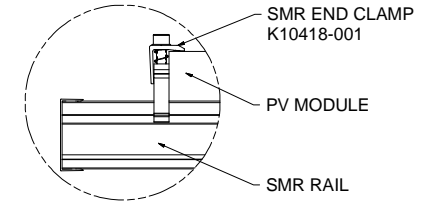

**DETAIL C**

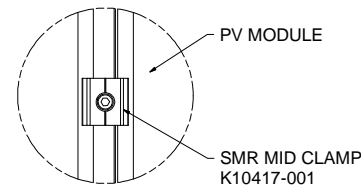

**DETAIL B**

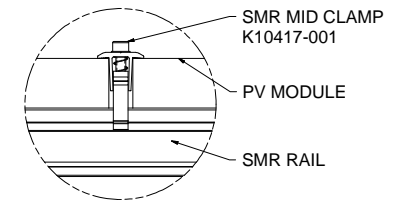

**DETAIL D**

<b>SunModo Corp.</b>	
TITLE SMR PITCHED ROOF SYSTEM	
D	DRAWING NUMBER D10245-V001
SCALE:	SHEET 1 of 5 REV

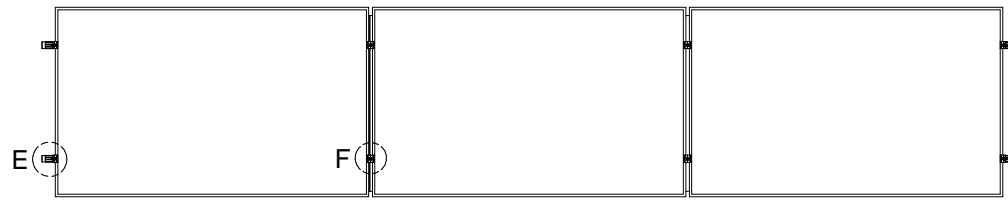

**PLAN VIEW**  
**SMR SYSTEM TRAPEZOIDAL METAL ROOF MOUNT, LANDSCAPE MODULE**

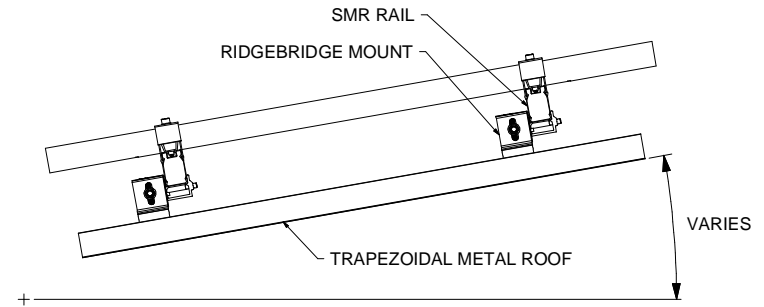

**SIDE VIEW**  
**SMR SYSTEM TRAPEZOIDAL METAL ROOF MOUNT, LANDSCAPE MODULE**

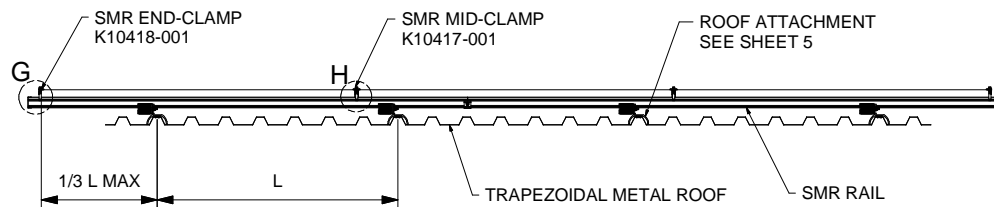

**FRONT VIEW**  
**SMR SYSTEM TRAPEZOIDAL METAL ROOF MOUNT, LANDSCAPE MODULE**

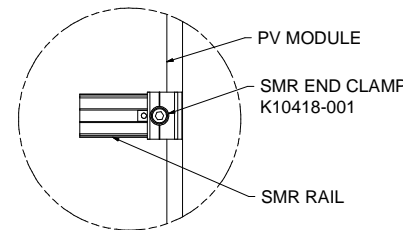

**DETAIL E**

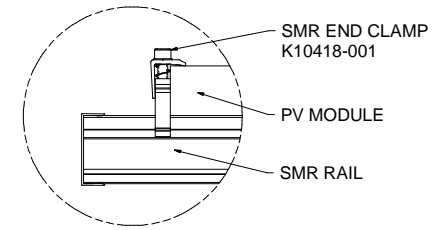

**DETAIL G**

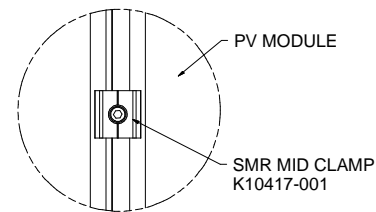

**DETAIL F**

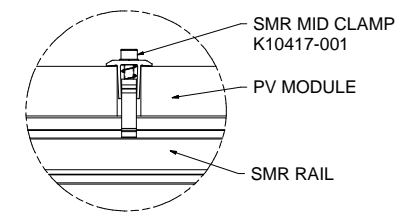

**DETAIL H**

<b>SunModo Corp.</b>	
TITLE SMR PITCHED ROOF SYSTEM	
D	DRAWING NUMBER D10245-V001
SCALE:	SHEET 2 of 5 REV

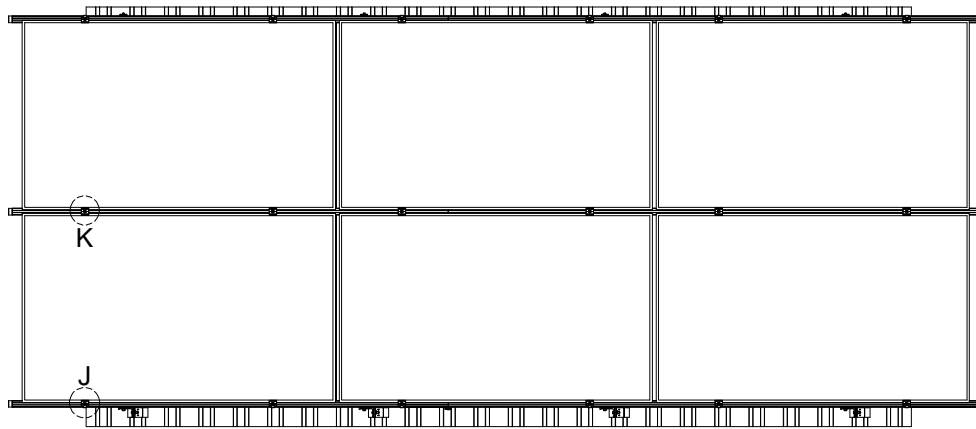

PLAN VIEW, SMR SYSTEM TRAPEZOIDAL METAL ROOF MOUNT, SHARED RAIL, LANDSCAPE MODULE

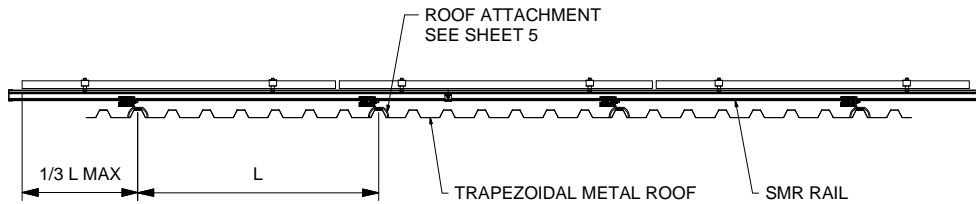

FRONT VIEW, SMR SYSTEM TRAPEZOIDAL METAL ROOF MOUNT, SHARED RAIL, LANDSCAPE MODULE

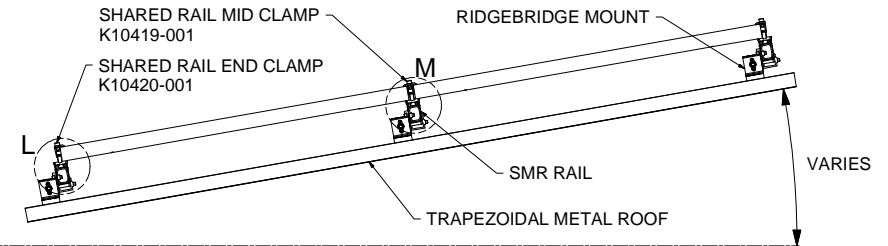

SIDE VIEW, SMR SYSTEM TRAPEZOIDAL METAL ROOF MOUNT, SHARED RAIL, LANDSCAPE MODULE

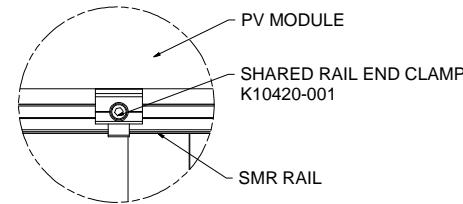

DETAIL J

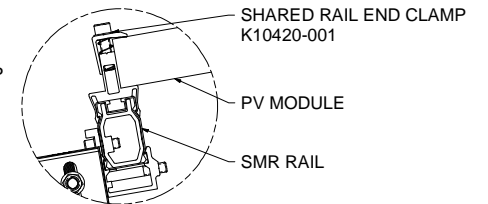

DETAIL L

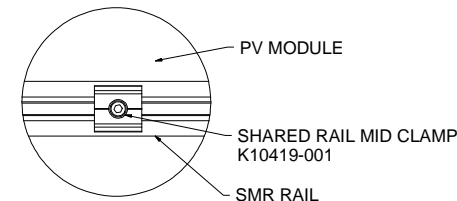

DETAIL K

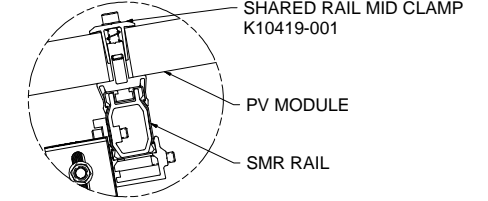

DETAIL M

<b>SunModo Corp.</b>	
TITLE SMR PITCHED ROOF SYSTEM	
D	DRAWING NUMBER D10245-V001
SCALE:	SHEET 3 of 5 REV

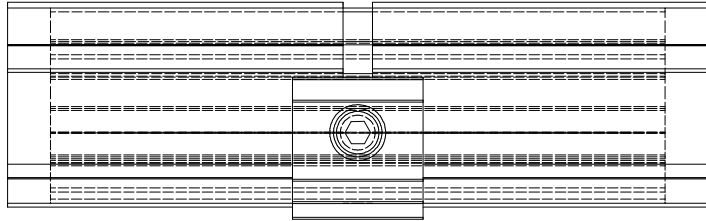

DETAIL, SPLICE CONNECTION, SMR RAIL

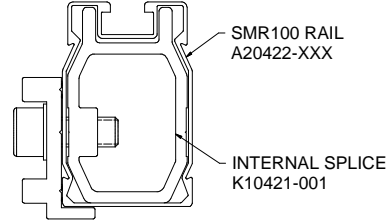

DETAIL, SPLICE, SMR100

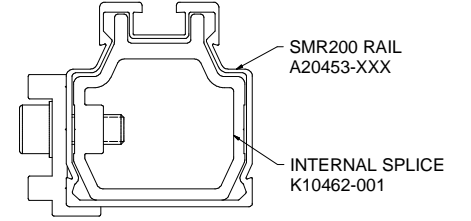

DETAIL, SPLICE, SMR200

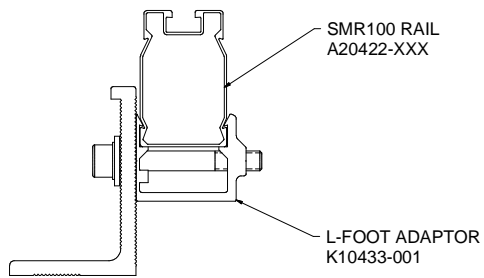

DETAIL, L-FOOT ADAPTOR, SMR100

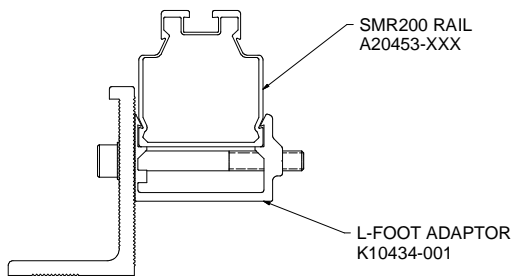

DETAIL, L-FOOT ADAPTOR, SMR200

<b>SunModo Corp.</b>	
TITLE SMR PITCHED ROOF SYSTEM	
D	DRAWING NUMBER: D10245-V001
SCALE:	SHEET 4 of 5 REV

# TRAPEZOIDAL METAL ROOF ATTACHMENT OPTIONS

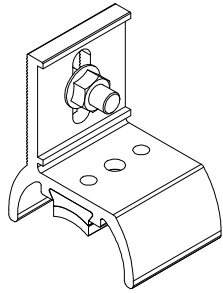

3/4 Pitch Height  
RidgeBridge Mount (no lag bolt)  
K10211-002

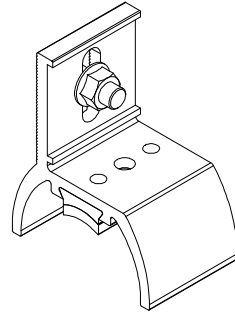

1 Pitch Height  
RidgeBridge Mount (no lag bolt)  
K10212-002

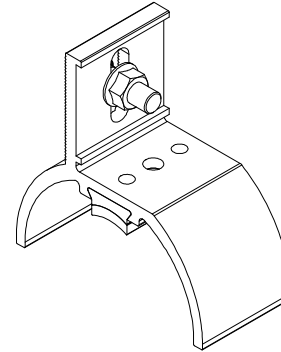

1-1/2 Pitch Height  
RidgeBridge Mount (no lag bolt)  
K10213-002

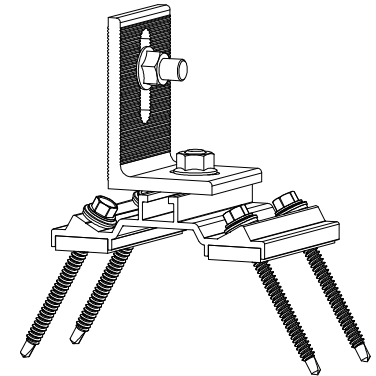

EZ Grip Metal Deck Mount  
K50532-001

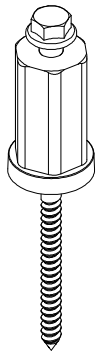

EZ Metal Roof Mount, 2" Standoff  
K10064-002

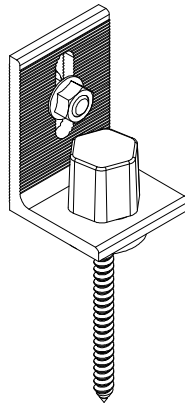

EZ Metal Roof Mount, EZ L-Footer  
K10082-001

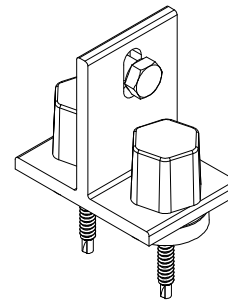

EZ Metal Roof Mount  
with 'T Foot' and Two Mount Holes  
K10154-001

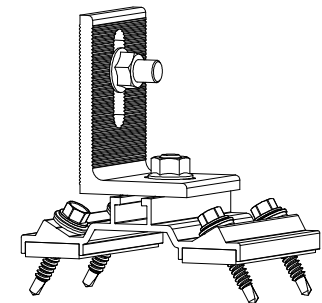

EZ Grip Metal Deck Mount  
(for 26ga SM)  
K50532-002

**SunModo Corp.**

TITLE	SMR PITCHED ROOF SYSTEM		
D	DRAWING NUMBER	D10245-V001	
SCALE:	SHEET	5	OF 5 REV