

PLAN VIEW, SMR SYSTEM STANDING SEAM ROOF MOUNT, PORTRAIT MODULE

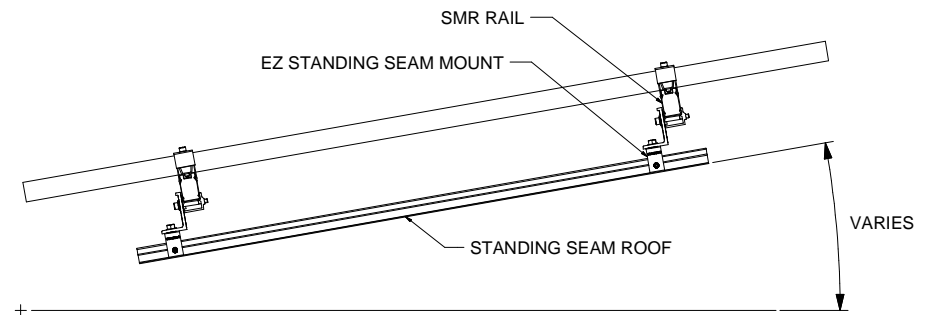

SIDE VIEW, SMR SYSTEM STANDING SEAM MOUNT, PORTRAIT MODULE

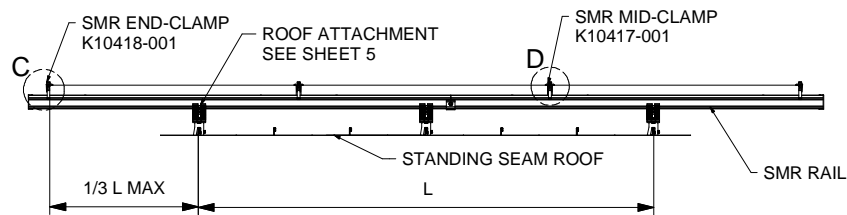

FRONT VIEW, SMR SYSTEM STANDING SEAM ROOF MOUNT, PORTRAIT MODULE

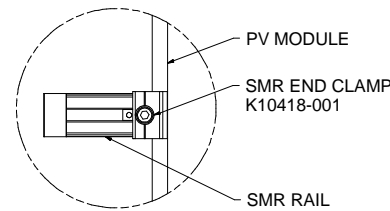

DETAIL A

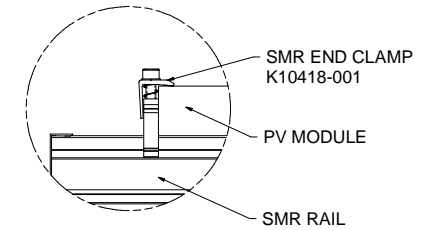

DETAIL C

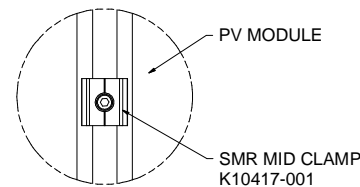

DETAIL B

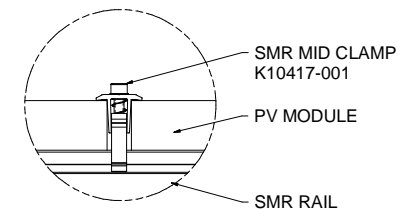

DETAIL D

SunModo Corp.	
TITLE SMR PITCHED ROOF SYSTEM	
D	DRAWING NUMBER D10241-V001
SCALE:	SHEET 1 of 5 REV

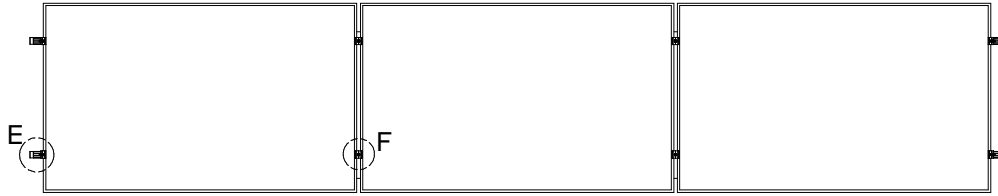

PLAN VIEW, SMR SYSTEM STANDING SEAM ROOF MOUNT, LANDSCAPE MODULE

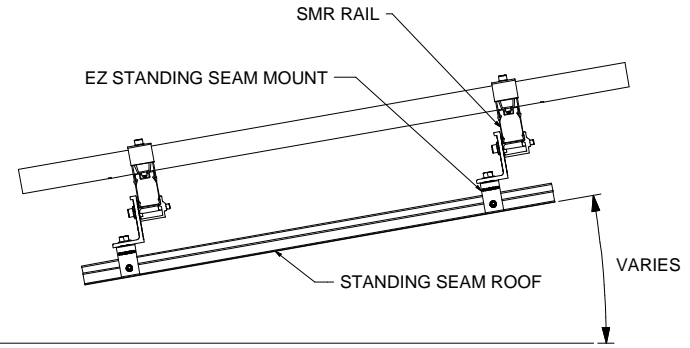

SIDE VIEW, SMR SYSTEM STANDING SEAM MOUNT, LANDSCAPE MODULE

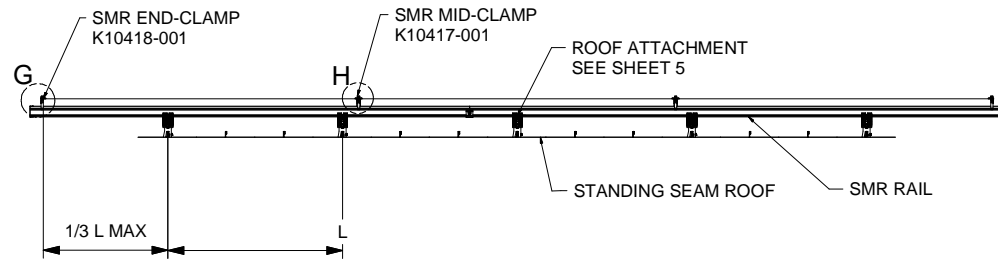

FRONT VIEW, SMR SYSTEM STANDING SEAM ROOF MOUNT, LANDSCAPE MODULE

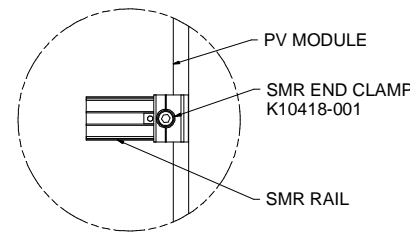

DETAIL E

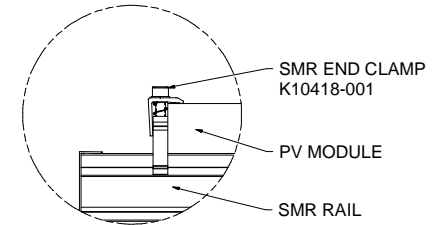

DETAIL G

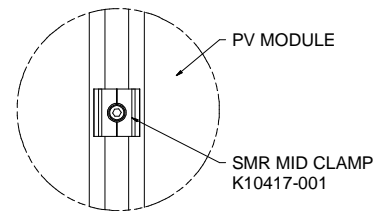

DETAIL F

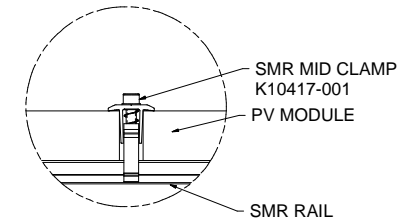

DETAIL H

SunModo Corp.	
TITLE SMR PITCHED ROOF SYSTEM	
D	DRAWING NUMBER D10241-V001
SCALE:	SHEET 2 of 5 REV

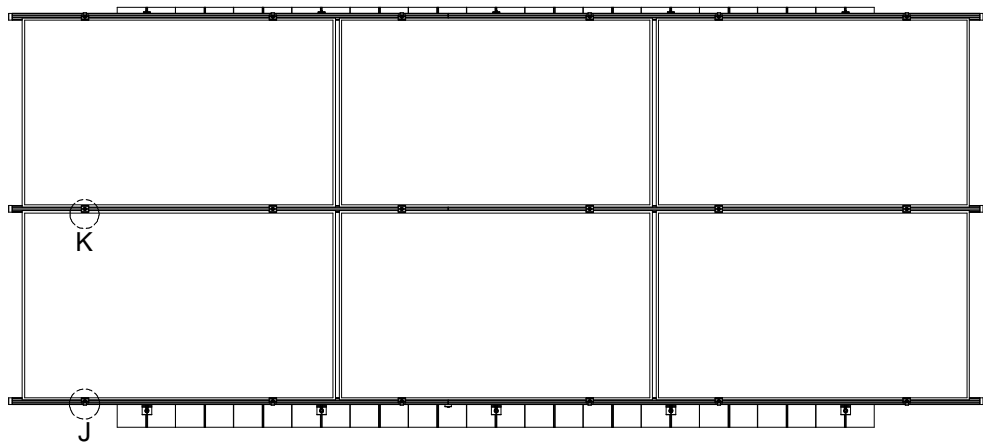

PLAN VIEW, SMR SYSTEM SHARED RAIL, LANDSCAPE MODULE

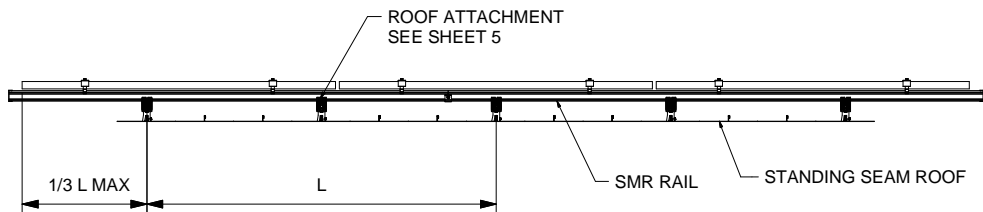

FRONT VIEW, SMR SYSTEM SHARED RAIL, LANDSCAPE MODULE

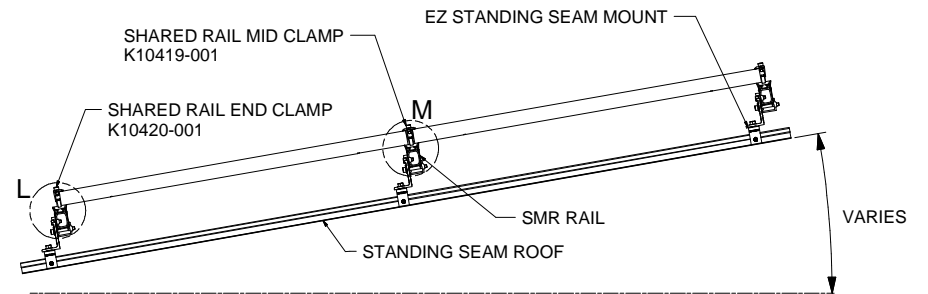

SIDE VIEW, SMR SYSTEM SHARED RAIL, LANDSCAPE MODULE

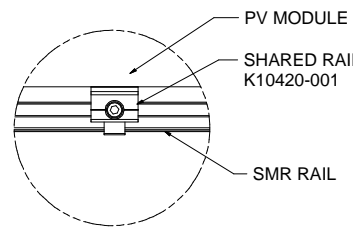

DETAIL J

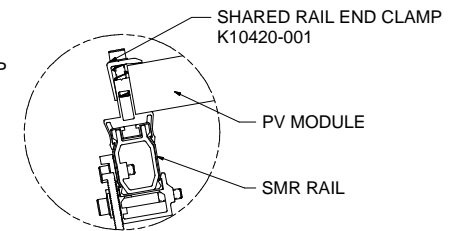

DETAIL L

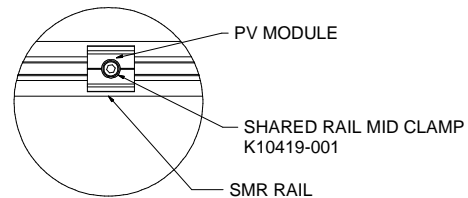

DETAIL K

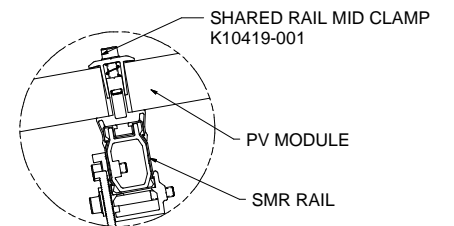

DETAIL M

SunModo Corp.	
TITLE SMR PITCHED ROOF SYSTEM	
D	DRAWING NUMBER: D10241-V001
SCALE:	SHEET 3 of 5 REV

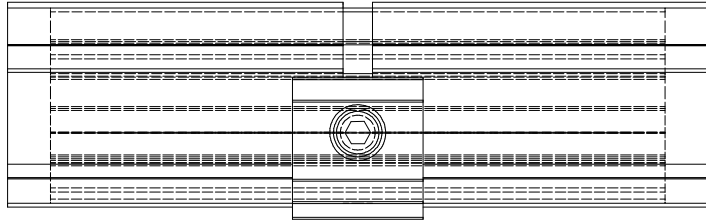

DETAIL, SPLICE CONNECTION, SMR RAIL

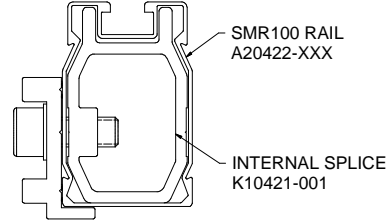

DETAIL, SPLICE, SMR100

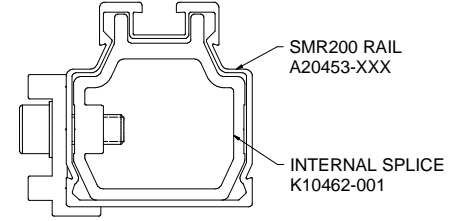

DETAIL, SPLICE, SMR200

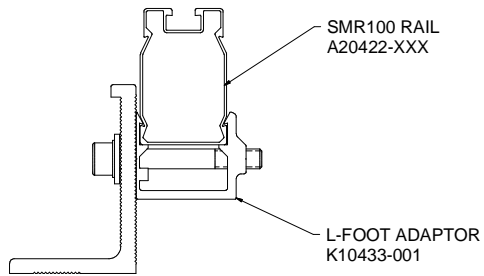

DETAIL, L-FOOT ADAPTOR, SMR100

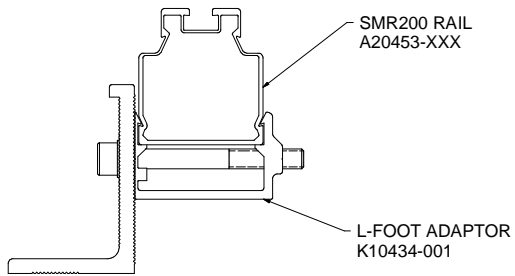

DETAIL, L-FOOT ADAPTOR, SMR200

SunModo Corp.			
TITLE SMR PITCHED ROOF SYSTEM			
DRAWING NUMBER: D10241-V001			
D	SHEET	4	of 5
SCALE:		REV	1

STANDING SEAM METAL ROOF ATTACHMENT OPTIONS

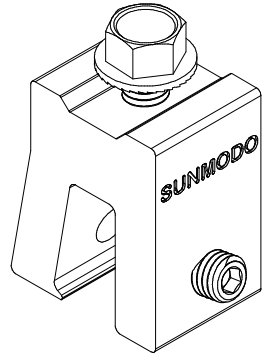

1" EZ STANDING SEAM CLAMP, MINI
K50200-002

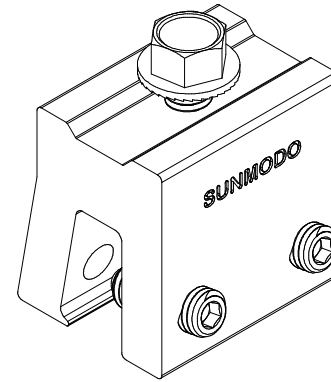

1" EZ STANDING SEAM CLAMP, STANDARD
K50200-001

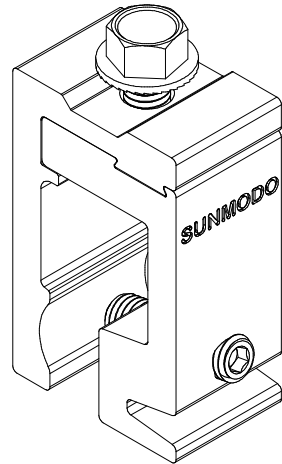

2" EZ STANDING SEAM CLAMP, MINI
K50210-002

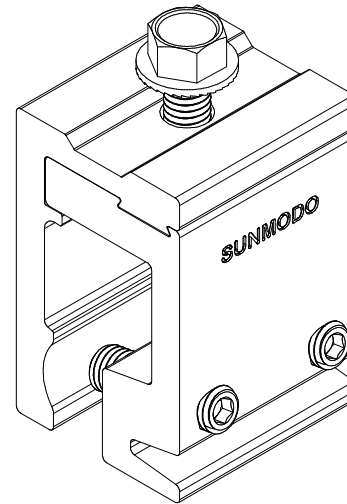

2" EZ STANDING SEAM CLAMP, STANDARD
K50210-001

SunModo Corp.	
TITLE: SMR PITCHED ROOF SYSTEM	
D	DRAWING NUMBER: D10241-V001
SCALE:	SHEET 5 of 5 REV