

**PLAN VIEW, SMR SYSTEM TILE ROOF MOUNT, PORTRAIT MODULE**

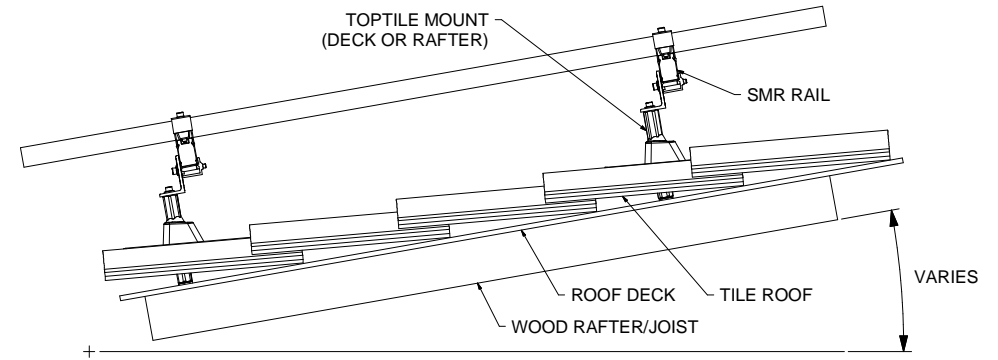

**SIDE VIEW, SMR SYSTEM TILE ROOF MOUNT, PORTRAIT MODULE**

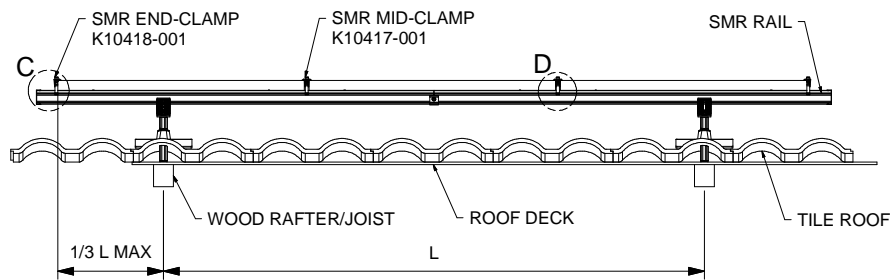

**FRONT VIEW, SMR SYSTEM TILE ROOF MOUNT, PORTRAIT MODULE**

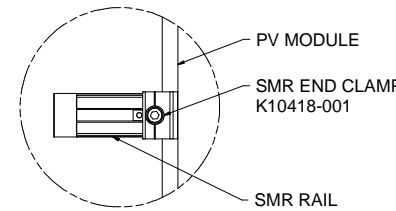

**DETAIL A**

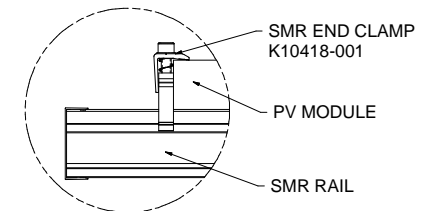

**DETAIL C**

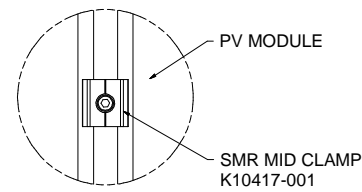

**DETAIL B**

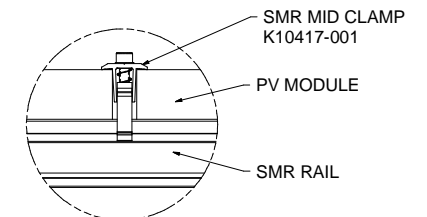

**DETAIL D**

<b>SunModo Corp.</b>	
TITLE SMR PITCHED ROOF SYSTEM	
D	DRAWING NUMBER D10240-V001
SCALE:	SHEET 1 of 5 REV

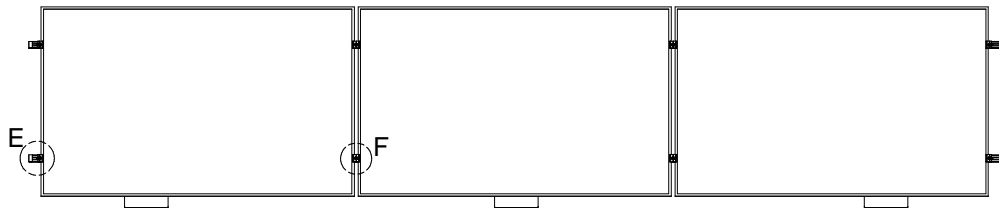

PLAN VIEW, SMR SYSTEM TILE ROOF MOUNT, LANDSCAPE MODULE

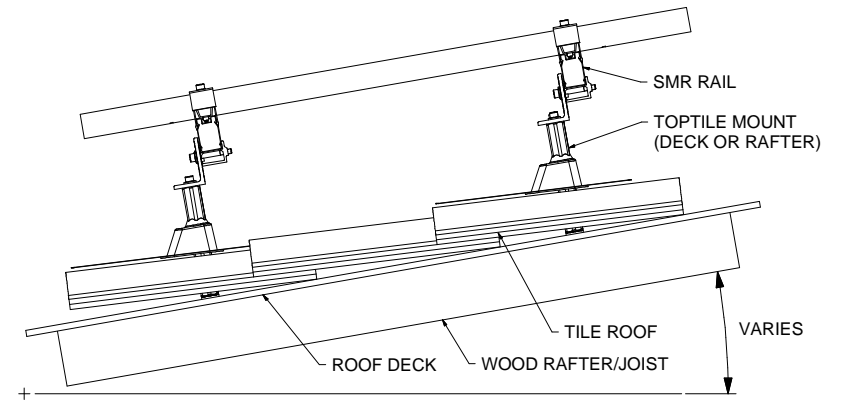

SIDE VIEW, SMR SYSTEM TILE ROOF MOUNT, LANDSCAPE MODULE

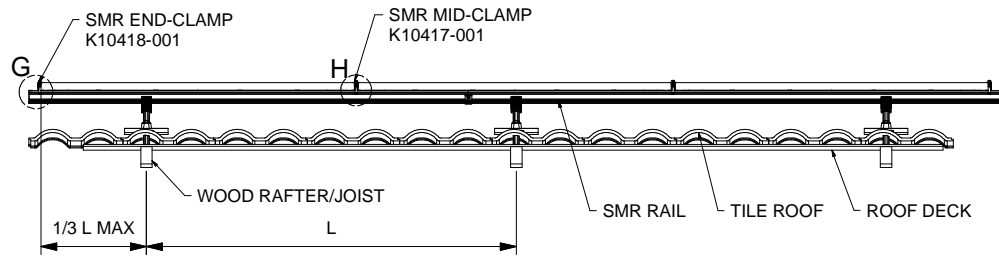

FRONT VIEW, SMR SYSTEM TILE ROOF MOUNT, LANDSCAPE MODULE

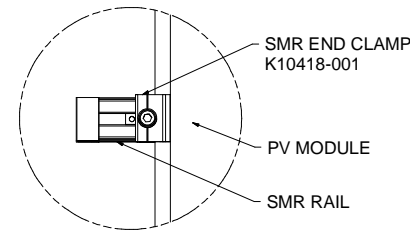

DETAIL E

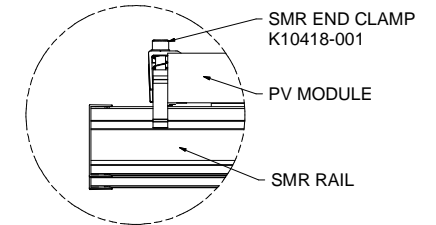

DETAIL G

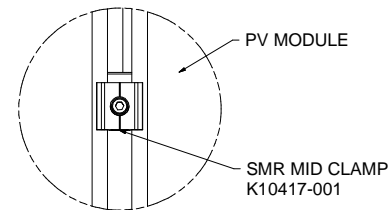

DETAIL F

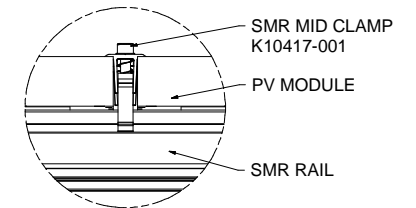

DETAIL H

<b>SunModo Corp.</b>	
TITLE SMR PITCHED ROOF SYSTEM	
D	DRAWING NUMBER D10240-V001
SCALE:	SHEET 2 of 5 REV

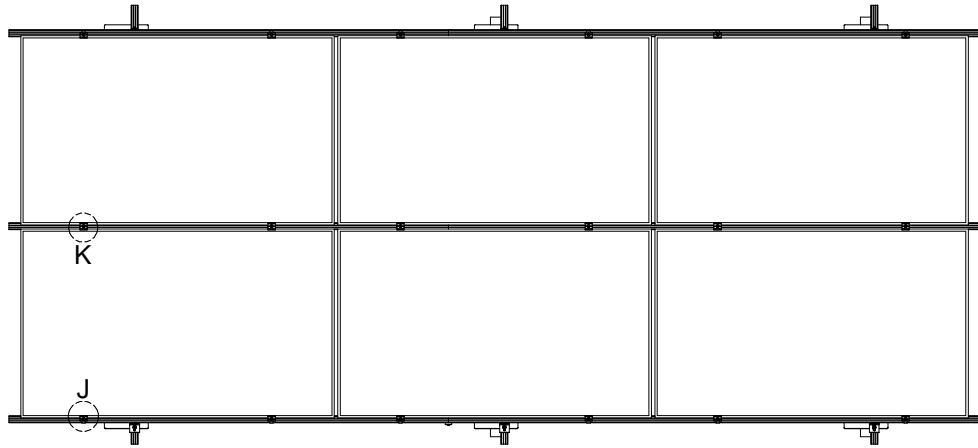

**PLAN VIEW, SMR SYSTEM SHARED RAIL, LANDSCAPE MODULE**

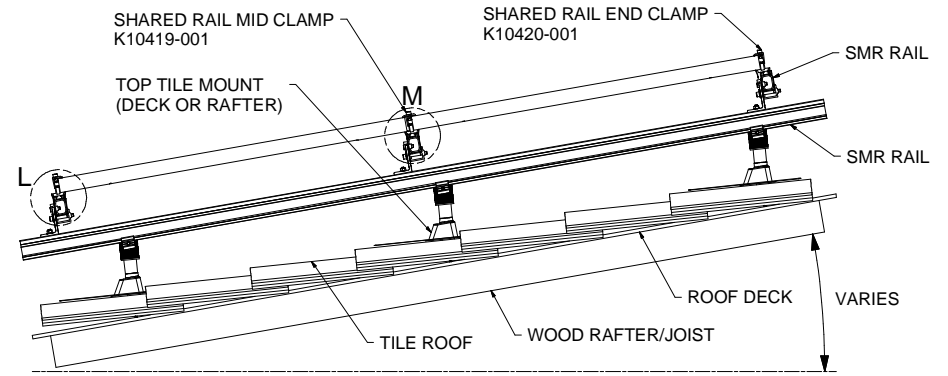

**SIDE VIEW, SMR SYSTEM SHARED RAIL, LANDSCAPE MODULE**

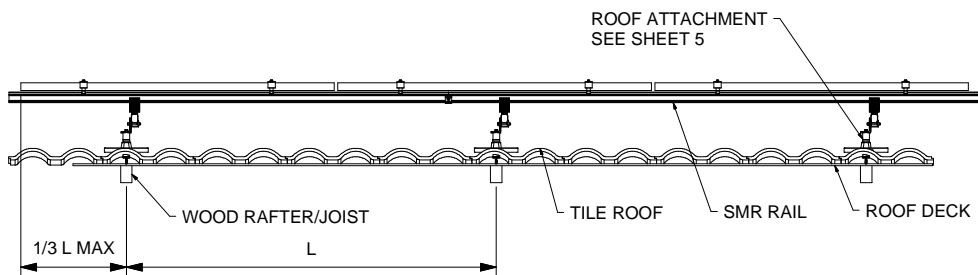

**FRONT VIEW, SMR SYSTEM SHARED RAIL, LANDSCAPE MODULE**

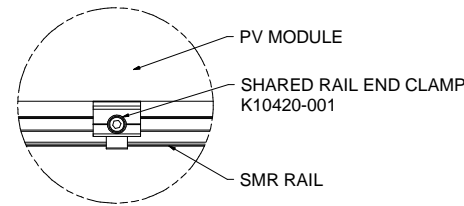

**DETAIL J**

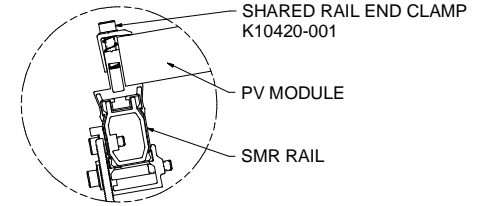

**DETAIL L**

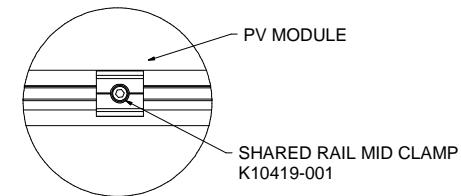

**DETAIL K**

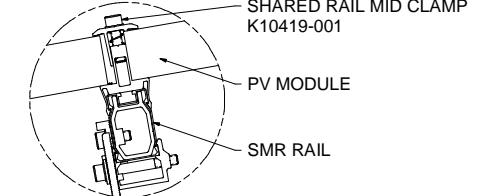

**DETAIL M**

<b>SunModo Corp.</b>	
TITLE SMR PITCHED ROOF SYSTEM	
D	DRAWING NUMBER D10240-V001
SCALE:	SHEET 3 of 5 REV

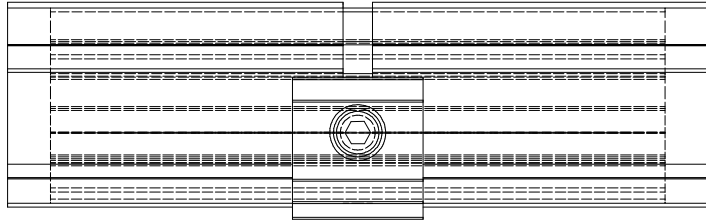

DETAIL, SPLICE CONNECTION, SMR RAIL

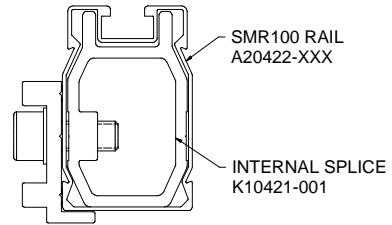

DETAIL, SPLICE, SMR100

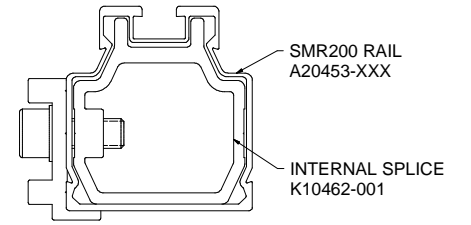

DETAIL, SPLICE, SMR200

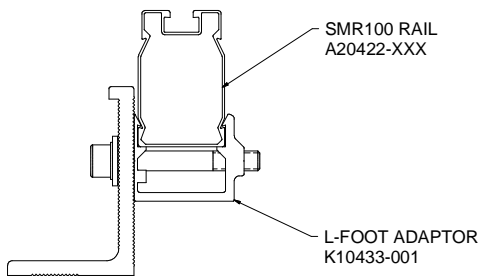

DETAIL, L-FOOT ADAPTOR, SMR100

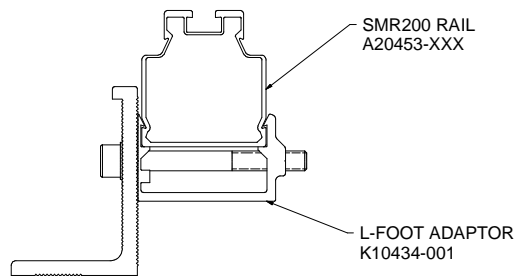

DETAIL, L-FOOT ADAPTOR, SMR200

<b>SunModo Corp.</b>			
TITLE SMR PITCHED ROOF SYSTEM			
DRAWING NUMBER: D10240-V001			
SCALE:	SHEET	4 of 5	REV

# TILE ROOF ATTACHMENT OPTIONS

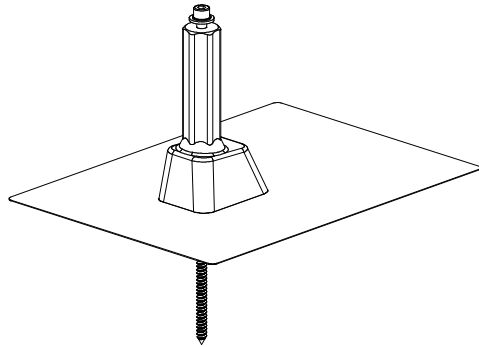

**TOPTILE MOUNT**  
K10466-XXX  
[RAFTER MOUNT]

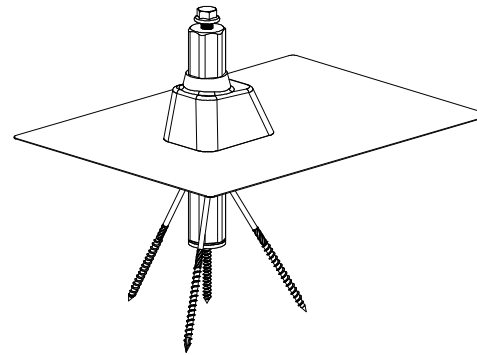

**TOPTILE MOUNT**  
K10461-XXX  
[DECK MOUNT]

<b>SunModo Corp.</b>			
TITLE SMR PITCHED ROOF SYSTEM			
D	DRAWING NUMBER: D10240-V001		
SCALE:	SHEET	5	of 5 REV