

PLAN VIEW, SMR SYSTEM RAFTER MOUNT, PORTRAIT MODULE

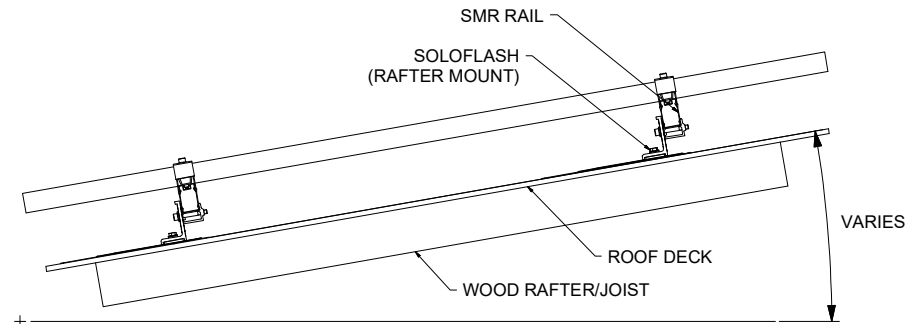

SIDE VIEW, SMR SYSTEM RAFTER MOUNT, PORTRAIT MODULE

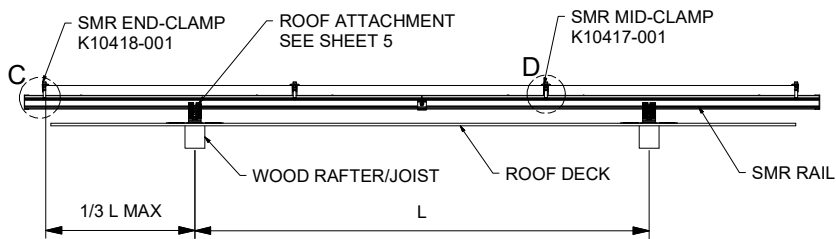

FRONT VIEW, SMR SYSTEM RAFTER MOUNT, PORTRAIT MODULE

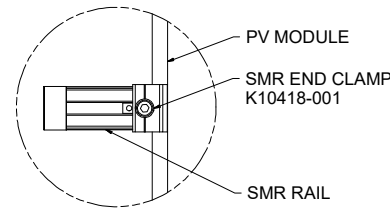

DETAIL A

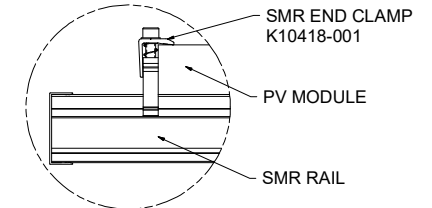

DETAIL C

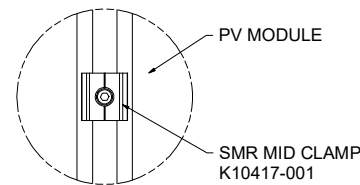

DETAIL B

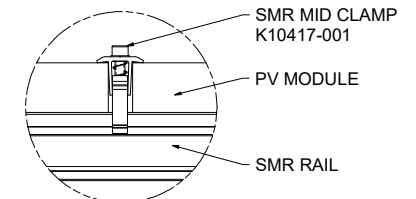

DETAIL D

SunModo Corp.	
TITLE SMR PITCHED ROOF SYSTEM	
D	DRAWING NUMBER D10239-V001
SCALE:	SHEET 1 of 5 REV

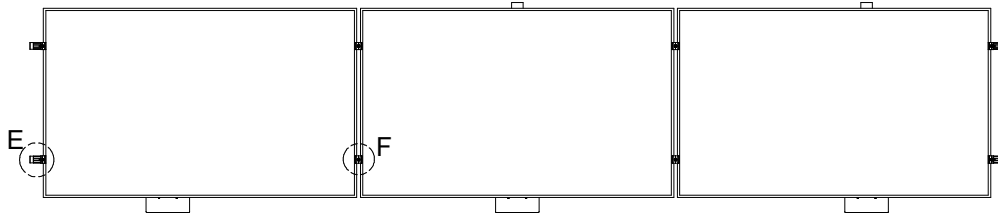

PLAN VIEW, SMR SYSTEM RAFTER MOUNT, LANDSCAPE MODULE

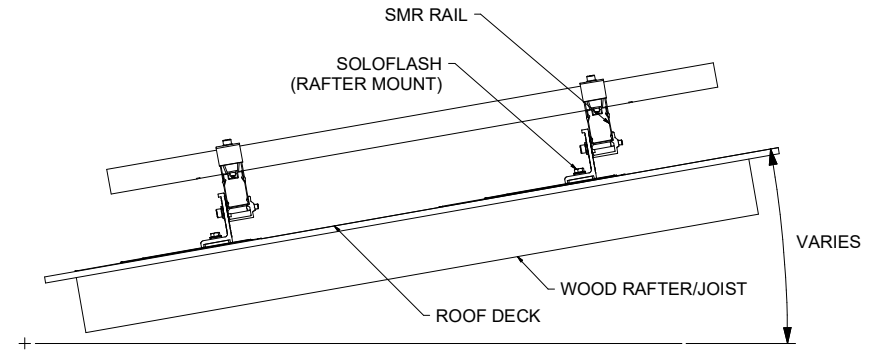

SIDE VIEW, SMR SYSTEM RAFTER MOUNT, LANDSCAPE MODULE

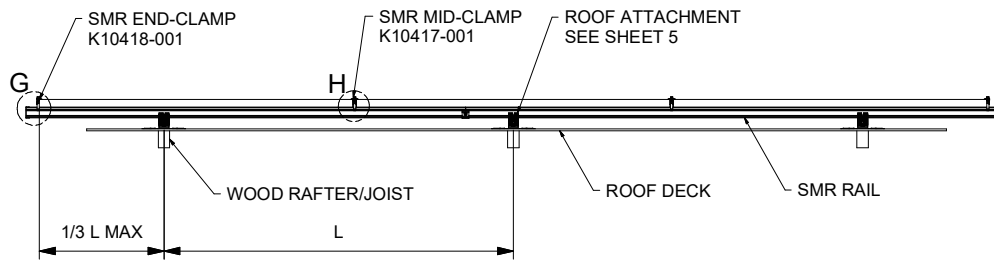

FRONT VIEW, SMR SYSTEM RAFTER MOUNT, LANDSCAPE MODULE

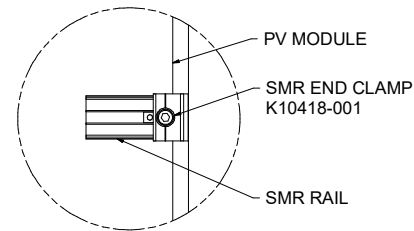

DETAIL E

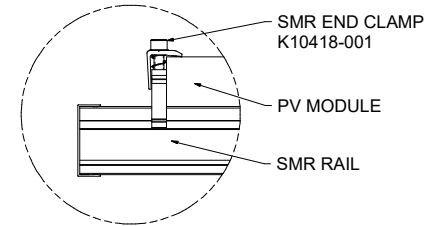

DETAIL G

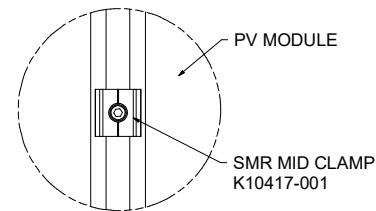

DETAIL F

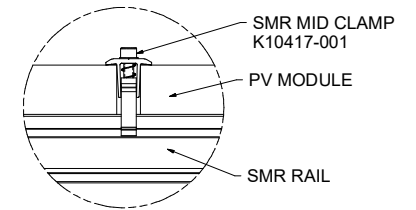

DETAIL H

SunModo Corp.		
TITLE SMR PITCHED ROOF SYSTEM		
DRAWING NUMBER: D10239-V001		
SCALE:	SHEET 2 of 5	REV

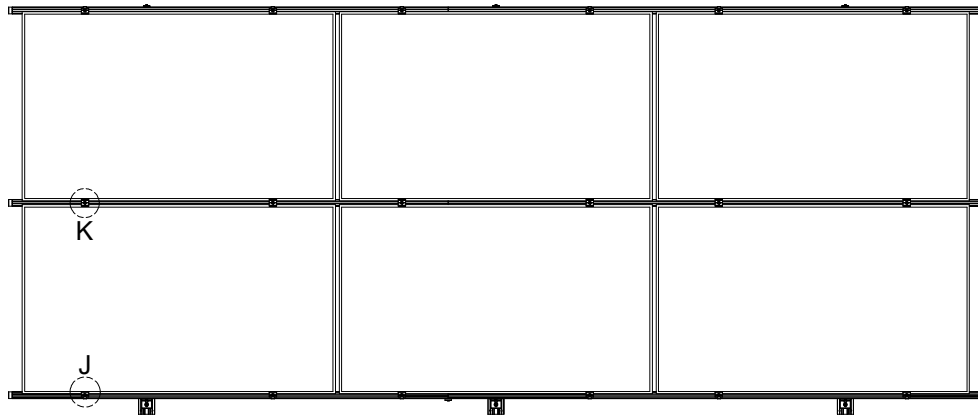

PLAN VIEW, SMR SYSTEM SHARED RAIL, LANDSCAPE MODULE

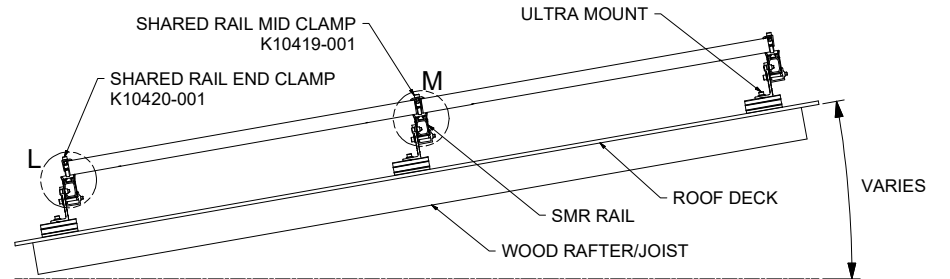

SIDE VIEW, SMR SYSTEM SHARED RAIL, LANDSCAPE MODULE

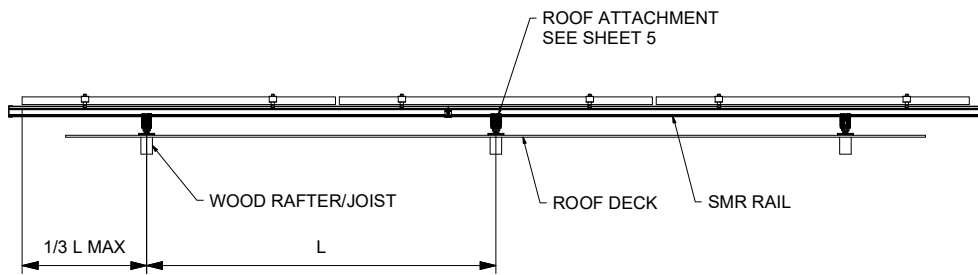

FRONT VIEW, SMR SYSTEM SHARED RAIL, LANDSCAPE MODULE

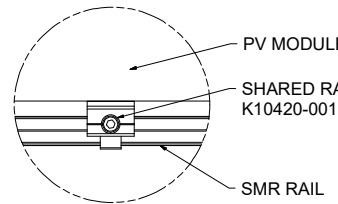

DETAIL J

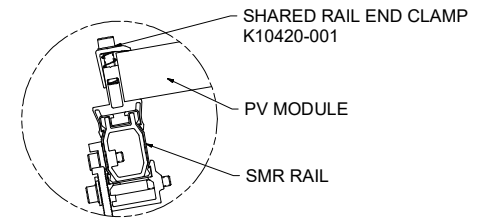

DETAIL L

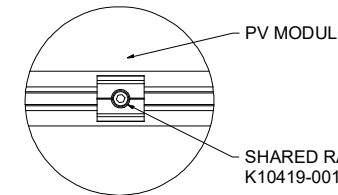

DETAIL K

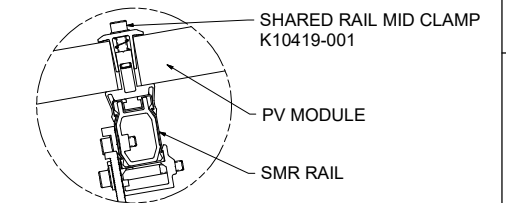

DETAIL M

SunModo Corp.	
TITLE SMR PITCHED ROOF SYSTEM	
D	DRAWING NUMBER D10239-V001
SCALE:	SHEET 3 of 5 REV

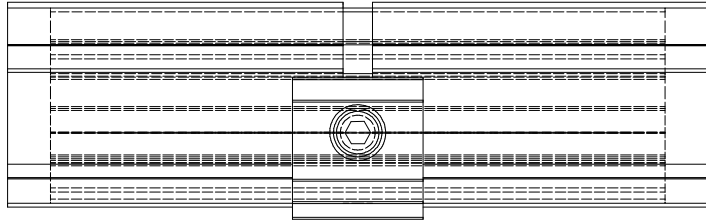

DETAIL, SPLICE CONNECTION, SMR RAIL

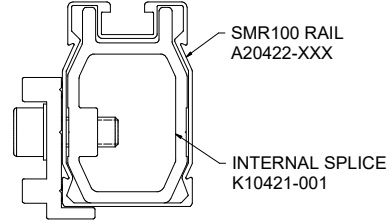

DETAIL, SPLICE, SMR100

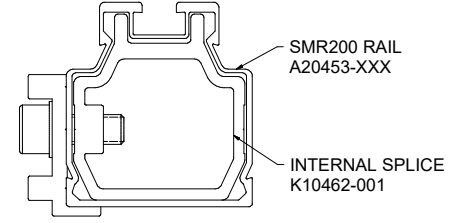

DETAIL, SPLICE, SMR200

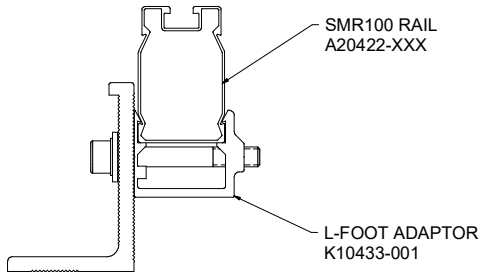

DETAIL, L-FOOT ADAPTOR, SMR100

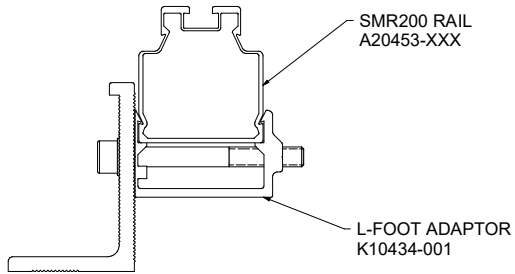

DETAIL, L-FOOT ADAPTOR, SMR200

SunModo Corp.			
TITLE SMR PITCHED ROOF SYSTEM			
DRAWING NUMBER: D10239-V001			
D	SHEET	4	of 5
SCALE:		REV	1

COMPOSITE SHINGLE ROOF ATTACHMENT OPTIONS

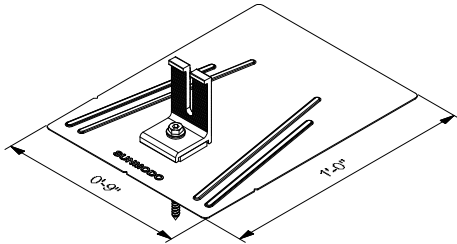

SOLOFLASH
K50538-003
[RAFTER MOUNT]

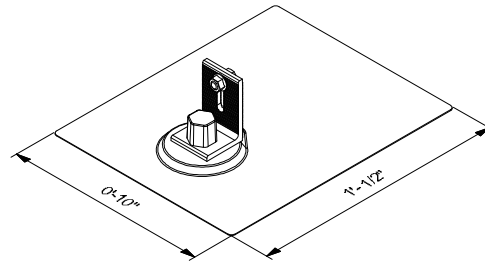

EZ ROOF MOUNT
K10068-001
[RAFTER MOUNT]

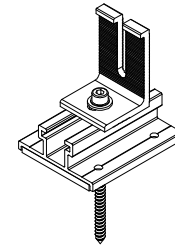

ULTRA RAFTER MOUNT
K50056-001

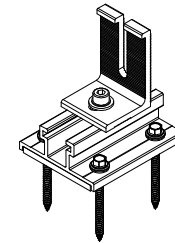

ULTRA DECK MOUNT
K50056-003

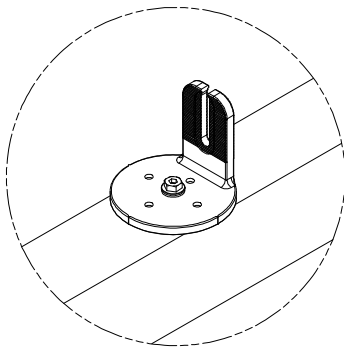

NANO RAFTER MOUNT
K50053-BK1

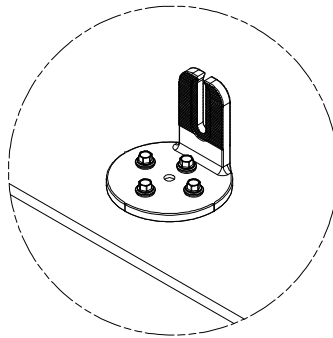

NANO DECK MOUNT
K50053-BK3

SunModo Corp.	
TITLE SMR PITCHED ROOF SYSTEM	
D	DRAWING NUMBER: D10239-V001
SCALE:	SHEET 5 of 5 REV