

**NOTES: UNLESS OTHERWISE SPECIFIED**

- THIS DRAWING IS NOT FOR CONSTRUCTION UNTIL ENGINEERING HAS REVIEWED AND STAMPED THIS DOCUMENT.
- DIMENSIONS SHOWN ARE INCHES.
- THE SELF-BONDING SYSTEM AND SINGLE GROUND LUG IS FOR USE WITH PV MODULES THAT HAVE A MAXIMUM SERIES FUSE RATING OF 30A.
- MATERIALS ARE AS SPECIFIED OR EQUIVALENT:  
HARDWARE: 304 STAINLESS STEEL  
FABRICATED EXTRUDED PARTS: 6005-T5 ALUMINUM ALLOY  
FABRICATED DIE CAST PARTS: ANSI/AA A380 ALUMINUM ALLOY  
STEEL PIPE: SCHEDULE 40 GALVANIZED  
ALUMINUM PIPE: SCHEDULE 10 ANODIZED
- THE MAXIMUM PERMISSIBLE LENGTH OF ANY STRUCTURE SHALL BE 200 FT. FOR SYSTEMS USING A SHARED RAIL CONFIGURATION, A THERMAL BREAK IS REQUIRED IN THE RAIL EVERY 40 FT. PER THE DRAWING DETAILS.
- 4LXN-3LXN-2PXN-35DEG-GSM-AGM-BGM-PGM.
- APPROVED RAIL PROFILES  
A20288-XXX (HR300 RAIL), A20297-001 (END CAP), K10343-002 (U-CLAMP KIT);  
A20145-XXX (HR350 RAIL), A20285-001 (END CAP), K10343-001 (U-CLAMP KIT);  
A20144-XXX (HR250 RAIL), A20284-001 (END CAP), K10343-001 (U-CLAMP KIT).
- K10224-XXX END CLAMP KIT OR K10299-XXX ADJ. END CLAMP KIT.
- FOUNDATION TYPES:  
GSM = GROUND SCREW GROUND MOUNT  
AGM = HELICAL AUGER GROUND MOUNT  
PGM = POST-IN-CONCRETE GROUND MOUNT  
BSM = BALLAST GROUND MOUNT

Firm License Number: 413000316  
VSE Project Number: U2716-113-191

11/10/2020

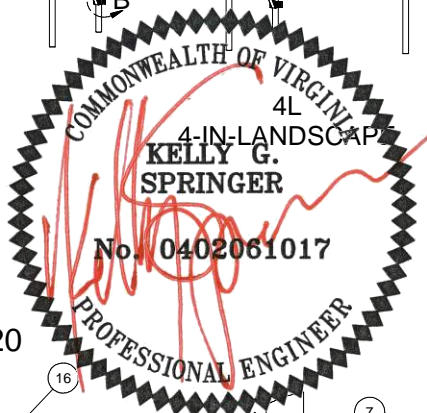
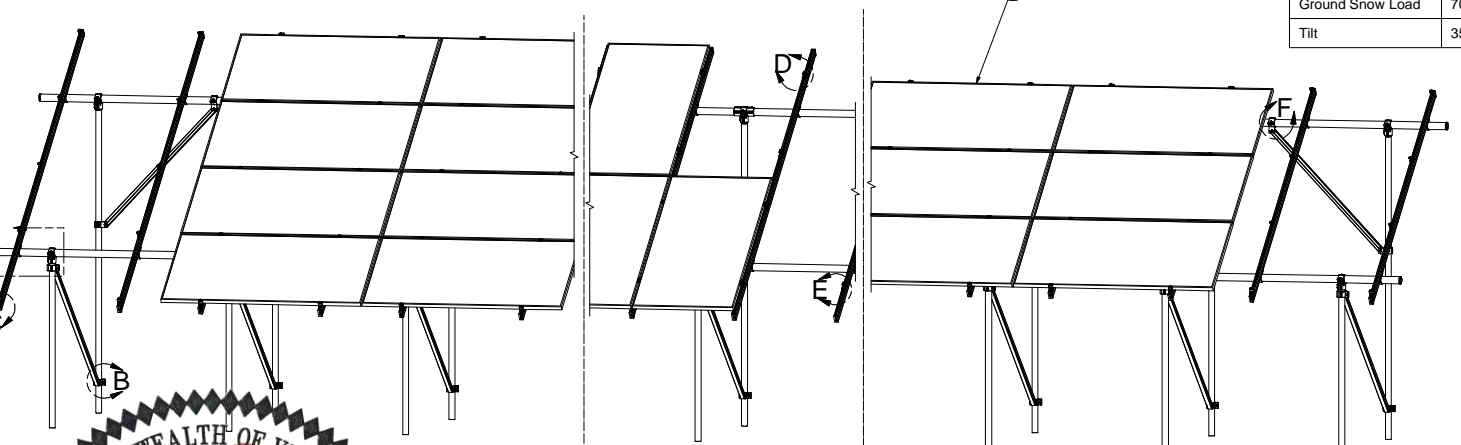

STRUCTURAL ONLY

**VECTOR ENGINEERS**  
651 W. GALENA PARK BLVD. STE. 101 DRAPER, UTAH 84020  
PHONE (801) 990-1775 WWW.VECTORSE.COM

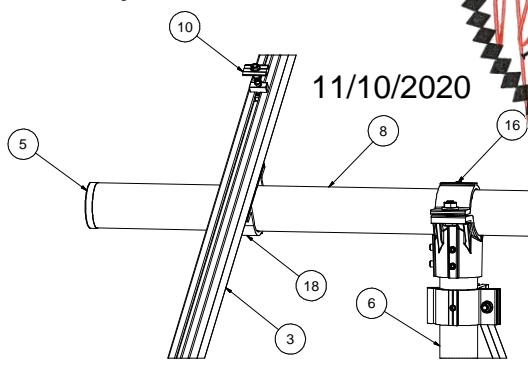

DETAIL A

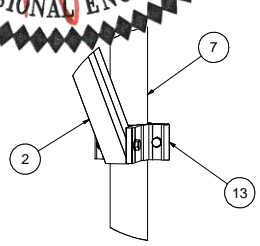

DETAIL B

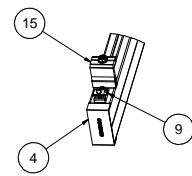

DETAIL C

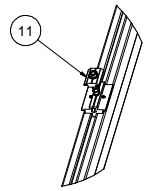

DETAIL D

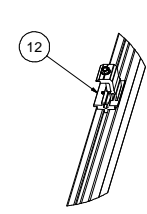

DETAIL E

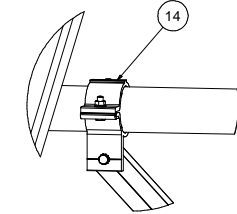

DETAIL F

Packet A4

Model Code	ASCE 7-10
Exposure Category	B
Wind Speed	110 mph and Lower
Ground Snow Load	70 PSF and Lower
Tilt	35 DEG and Lower

18	K10343-001	2.5" AL PIPE U-CLAMP KIT	
17	K10342-001	2.5" PIPE SPLICE KIT	
16	K10341-001	2.5" PIPE TEE KIT	
15		END CLAMP KIT. VARIES PER NOTE 8	
14	K10222-001	2.5" PIPE CLAMP KIT	
13	K10219-001	2" AL PIPE CLAMP KIT	
12	K10183-XXX	LANDSCAPE GROUNDING END CLAMP KIT	
11	K10182-001	LANDSCAPE GROUNDING MID CLAMP KIT	
10	K10180-001	GROUNDING MID-CLAMP KIT WITH T COLLAR BOLT AND GROUNDING BASE	
9	K10179-001	SELF-GROUNDING LUG KIT	
8	A21168-XXX	PIPE, HSS, 2.875" OD X 12 GAUGE, L=XXX	
7	A21165-XXX (REAR)	PIPE, HSS, 2.375" OD X 12 GAUGE, L=XXX	
6	A21165-XXX (FRONT)	PIPE, HSS, 2.375" OD X 12 GAUGE, L=XXX	
5	A20380-001	2.5" PIPE END CAP	
4		HELIO RAIL END CAP. VARIES PER NOTE 7	
3		HELIO RAIL. VARIES PER NOTE 7	
2	A50164-XXX	1.5" SQ. STL TUBE BRACE, L=XXX	
1		PANEL	

ITEM PART NUMBER DESCRIPTION QTY

SEE BOM

**SunModo Corp.**  
14800 NE 65TH STREET, VANCOUVER WA 98682

TITLE: PACKET A4  
DATE: 08/26/2019  
DRAWING NUMBER: D

SCALE: SHEET 1 of 4

THIS DRAWING IS CONFIDENTIAL PROPERTY OF SUNMODO AND ITS CONTENTS MAY NOT BE DISCLOSED WITHOUT THE PRIOR WRITTEN CONSENT OF SUNMODO CORP.

**NOTES:**  
 1. DIMENSIONS LABELED AS MAX ARE MAXIMUM ALLOWABLE  
 AND MAY RESULT IN END POSTS BEING OUTSIDE ARRAY EDGES.  
 MAXIMUM DIMENSIONS MAY BE REDUCED IF DESIRED.

**RAIL SPACING**  
 LANDSCAPE: PER PANEL MANUFACTURER  
 PORTRAIT: PANEL WIDTH + 0.25"

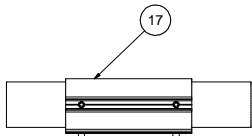

DETAIL G

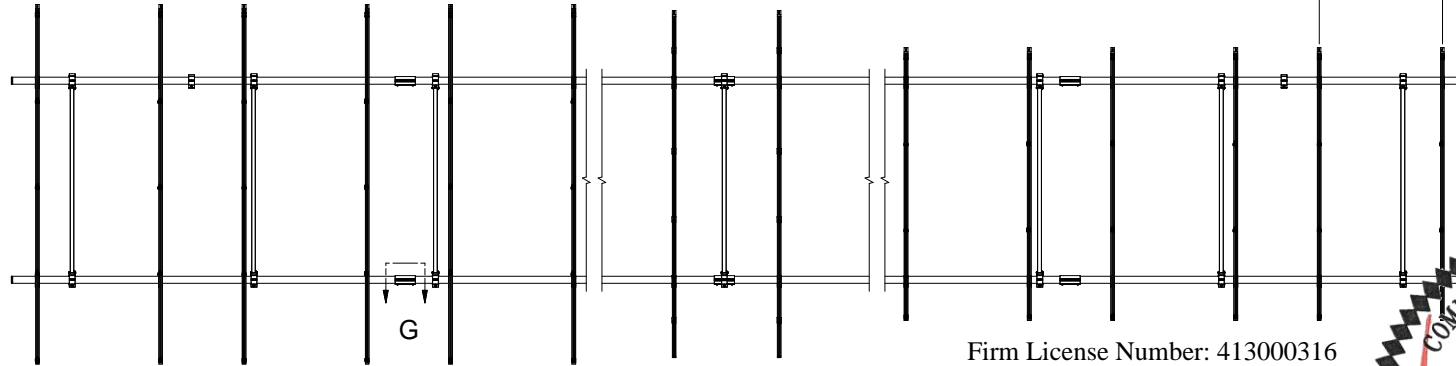

Firm License Number: 413000316  
 VSE Project Number: U2716-113-191



651 W. GALENA PARK BLVD. STE. 101 DRAPER, UTAH 84020  
 PHONE (801) 990-1775 WWW.VECTORSE.COM

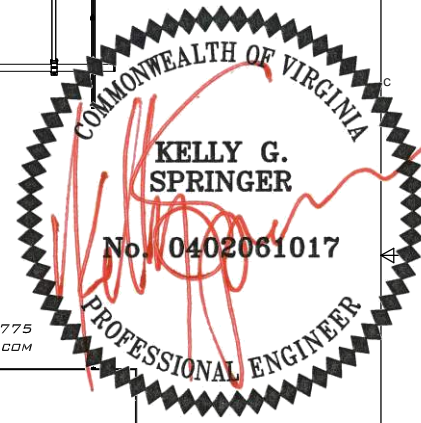

11/10/2020

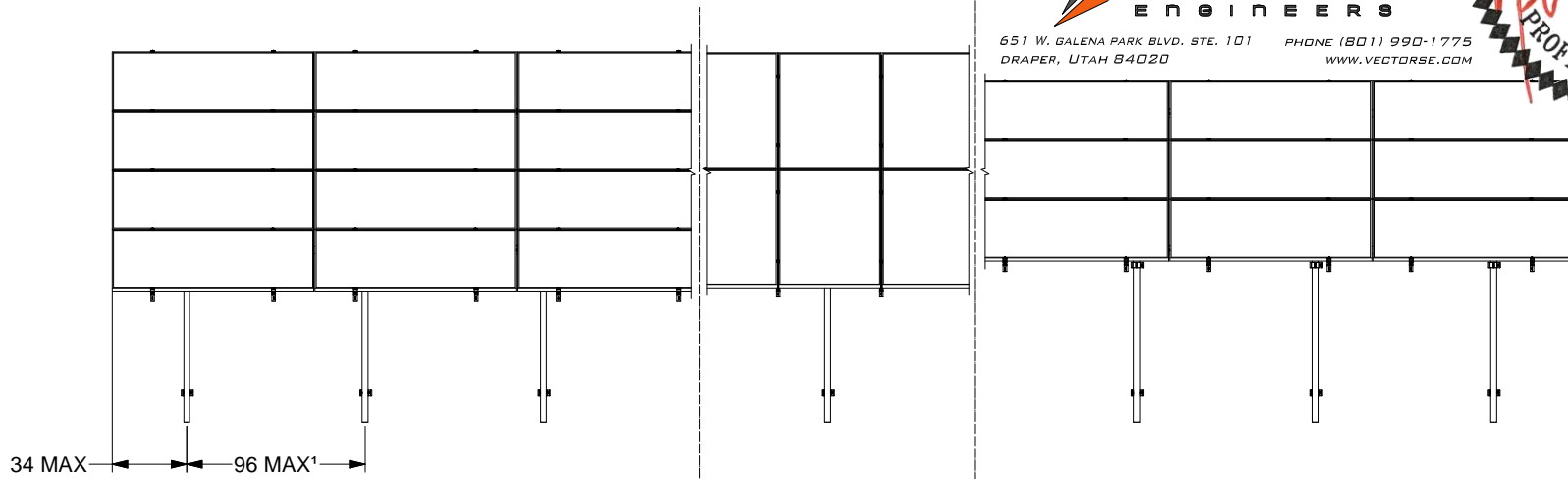

4L  
4-IN-LANDSCAPE

2P  
2-IN-PORTRAIT

3L  
3-IN-LANDSCAPE

SunModo Corp.	
TITLE	PACKET A4
D	DRAWING NUMBER
SCALE:	SHEET 2 of 4 REV

DIMENSIONS			
ITEM	4L	2P	3L
A	172	166	130
B	37	34	16
C	56	54	44
D	112	110	100

**NOTES**  
 1. DIMENSIONS IN TABLE ARE SHOWN AT MAXIMUM TILT & LEADING EDGE HEIGHT. PROJECTS WITH LOWER TILTS & LEADING EDGE HEIGHTS WILL RESULT IN REDUCED DIMENSIONS.  
 2. MAX DENOTES MAXIMUM PERMISSIBLE DIMENSIONS.

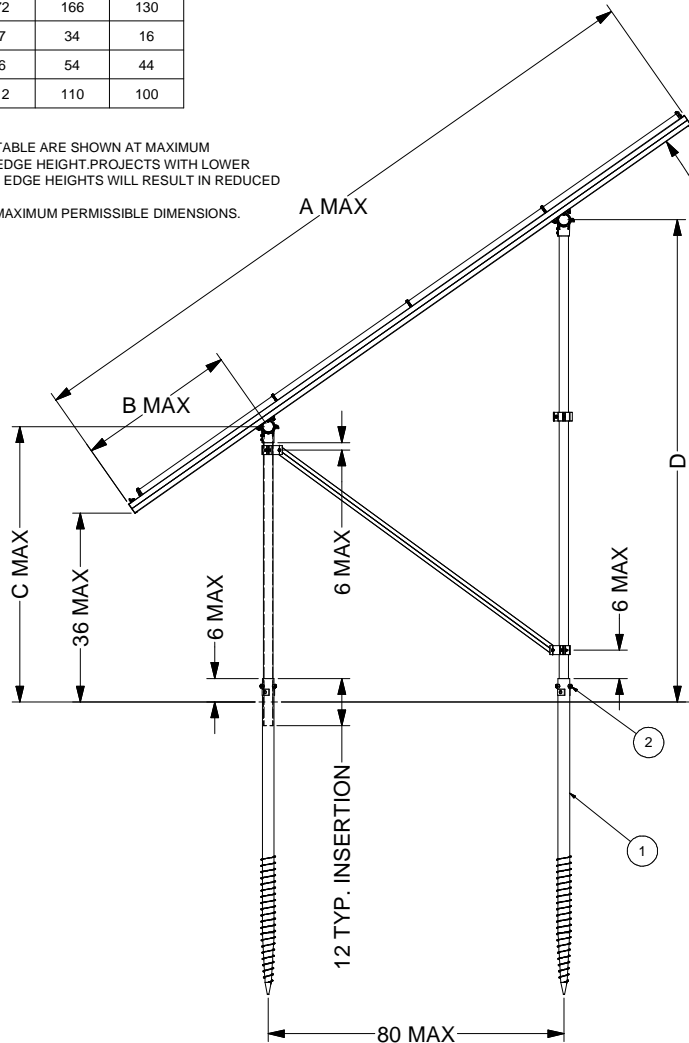

**GROUND SCREW GROUND MOUNT (GSM)**

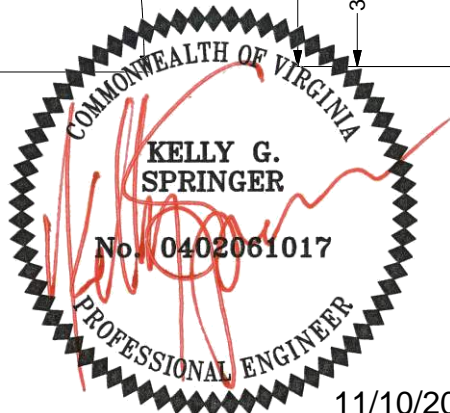

11/10/2020

Firm License Number: 413000316  
 VSE Project Number: U2716-113-191  
**STRUCTURAL ONLY**

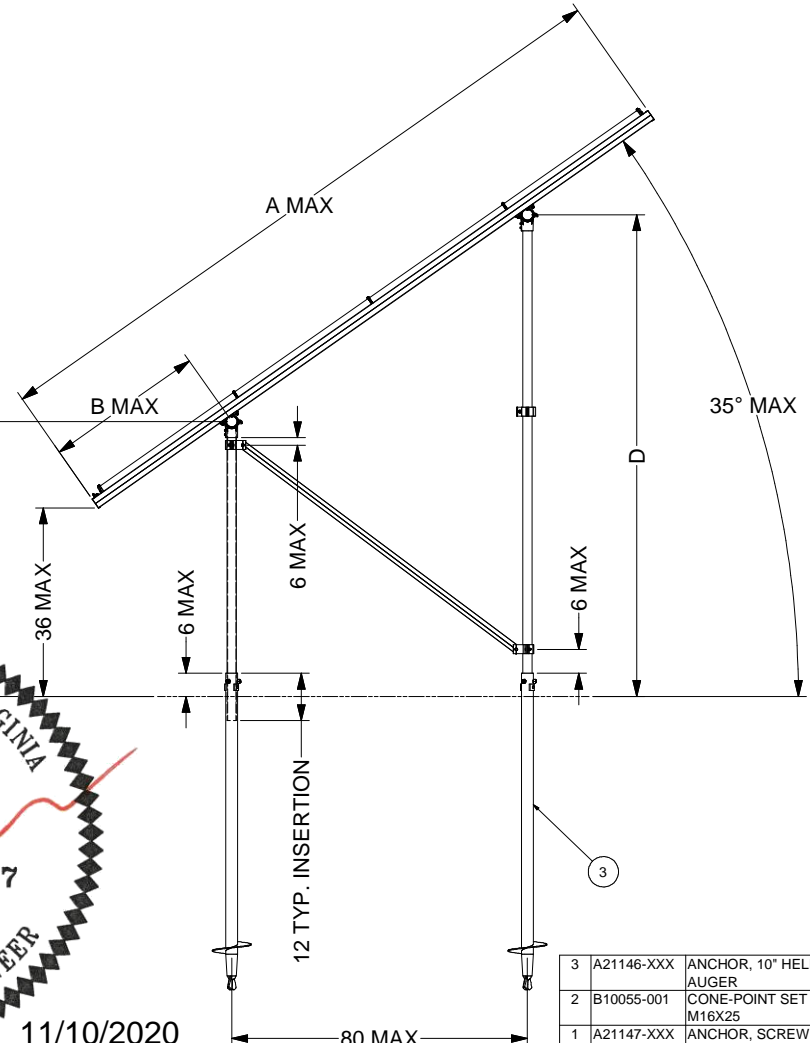

**AUGER GROUND MOUNT (AGM)**

ITEM	PART NUMBER	DESCRIPTION	QTY
3	A21146-XXX	ANCHOR, 10" HELIX BLADE AUGER	
2	B10055-001	CONE-POINT SET SCREW M16X25	
1	A21147-XXX	ANCHOR, SCREW AUGER, L=XXX	

**SunModo Corp.**  
 TITLE: PACKET A4  
 D: DRAWING NUMBER  
 SCALE: SHEET 3 of 4 REV

DIMENSIONS			
ITEM	4L	2P	3L
A	172	166	130
B	37	34	16
C	56	54	44
D	112	110	100

- NOTES**
1. DIMENSIONS IN TABLE ARE SHOWN AT MAXIMUM TILT & LEADING EDGE HEIGHT. PROJECTS WITH LOWER TILTS & LEADING EDGE HEIGHTS WILL RESULT IN REDUCED DIMENSIONS.
  2. MAX DENOTES MAXIMUM PERMISSIBLE DIMENSIONS.
  3. K10268-005 (2" PIPE BASE KIT) OR K10302-001 (2" PIPE BASE KIT)

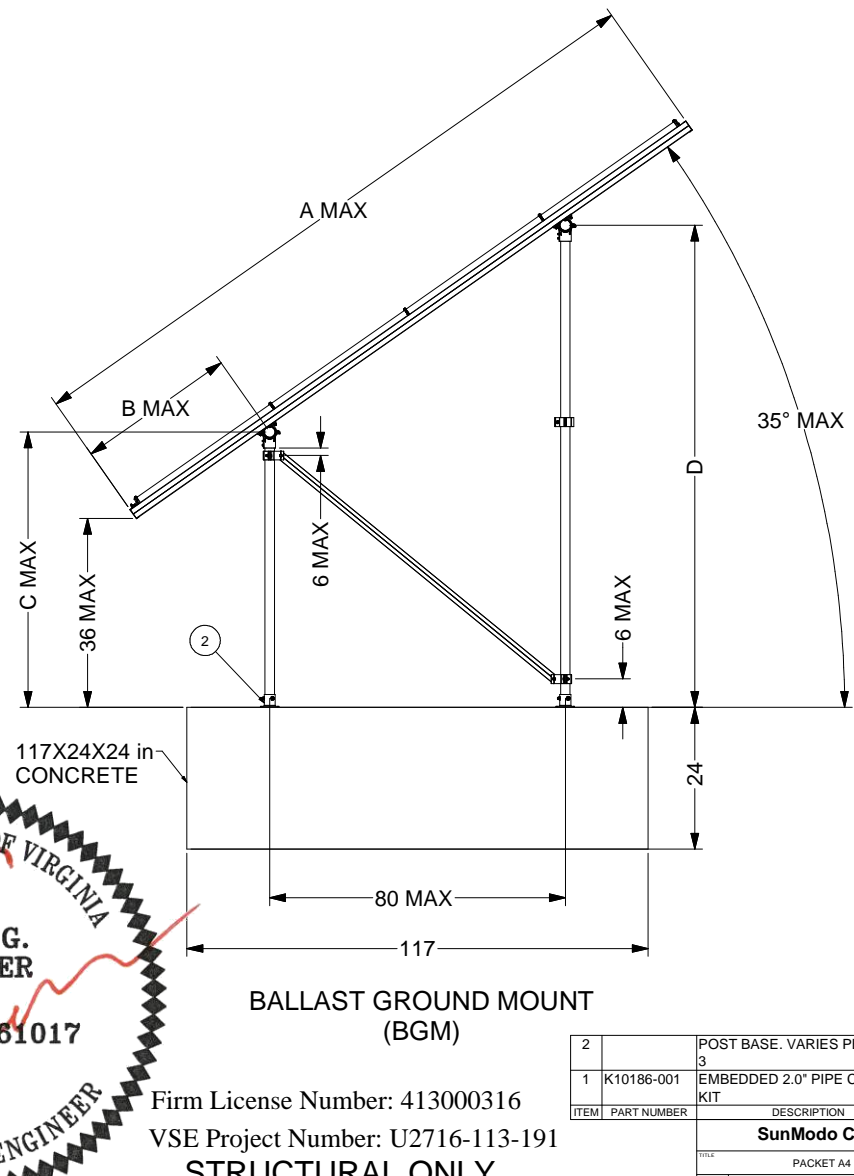
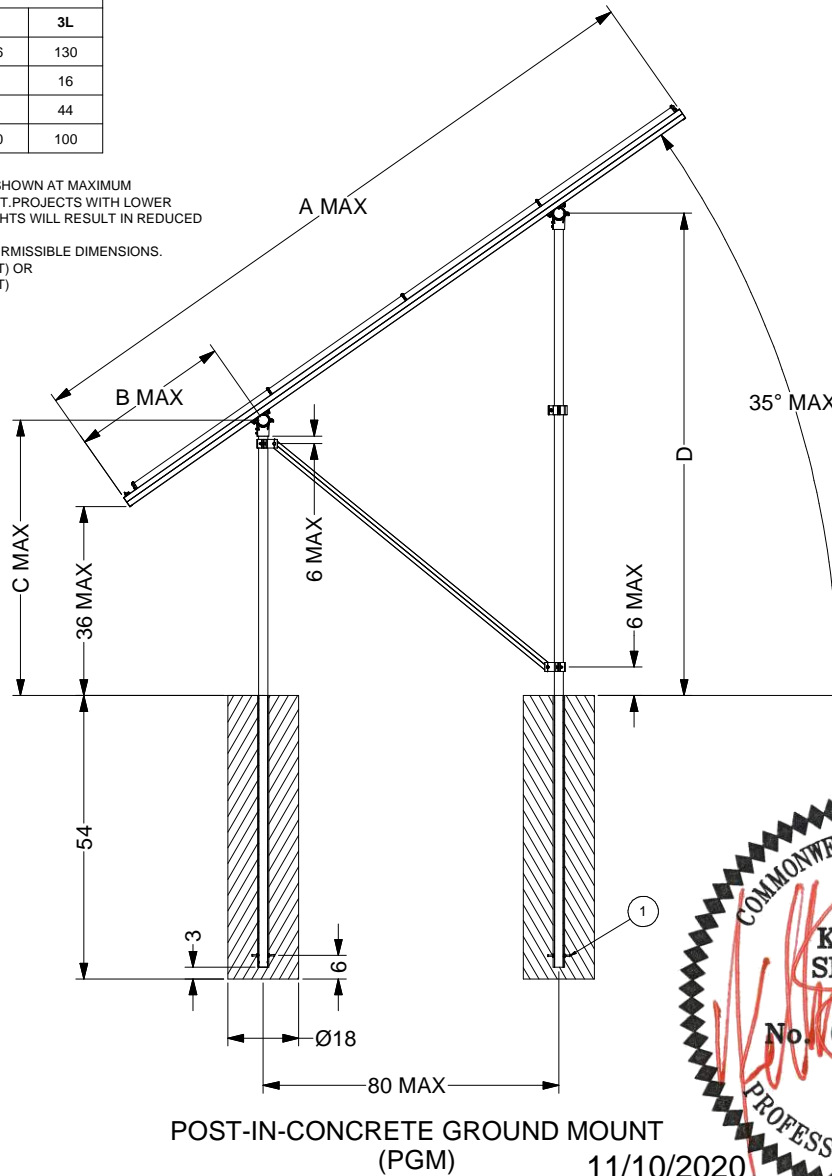

Firm License Number: 413000316  
 VSE Project Number: U2716-113-191  
**STRUCTURAL ONLY**

2		POST BASE. VARIES PER NOTE	
3		EMBEDDED 2.0" PIPE CLAMP KIT	
1	K10186-001	EMBEDDED 2.0" PIPE CLAMP KIT	
ITEM	PART NUMBER	DESCRIPTION	QTY
<b>SunModo Corp.</b>			
TITLE: PACKET A4			
D: DRAWING NUMBER			
SCALE:		SHEET 4 of 4	REV

