



Project Number: U2716-0218-201

JuLY 6, 2020

Sunmodo
14800 NE 65th Street
Vancouver, WA 98682

**REFERENCE: Sunmodo Sunturf Ground Mount A8
Ground Mount PV Array Installation**

To Whom It May Concern:

Per request of Sunmodo, we have been asked to prepare the structural design of a ground-mounted PV solar array system with several foundation options as shown in the attached calculations. The adopted building code in this jurisdiction is the Massachusetts State Building Code (780 CMR Chapter 16, 9th Edition (2015 IBC)). Vector Structural Engineering requires that we review each site specific install, and we are not liable for installs at site specific locations we have not reviewed. The following design parameters are used in our analysis:

- Minimum Design Loads for Buildings and Other Structures (ASCE 7-10)
- Design wind speed for risk category I structures: 115 mph
- Wind exposure: C
- Ground snow load: 50 psf
- The ground screws and helical piers must be tested to 1.5 times uplift and 2.0 times lateral reactions found in the table below. A minimum of one ground screw or helical pier must be tested.

Load (ASD)	Value (lbs)	Factor of Safety	Test Value (lbs)
UPLIFT	2305	1.5	3460
LATERAL	1615	2	3230

Foundation concrete shall have a minimum compressive strength of 2500 psi at 28 days. Cement for all concrete shall be Type I or II with a minimum of 6% entrained air with a water/cement ratio of 0.50. Maximum aggregate size shall be 3/4". No special inspection of concrete strength is required.

Footings are designed based on an allowable soil bearing pressure of 1500 psf an allowable skin friction of 250 psf, an allowable lateral bearing pressure of 150 pcf, and a coefficient of friction of 0.3. Vector Structural Engineering strongly recommends independent soils testing be performed by a licensed geotechnical engineer to verify the assumed soil parameters.

All ground mounts are to be installed per manufacturer’s recommendations. The use of solar panel support span tables provided by the manufacturer is allowed only where the site conditions and solar panel configuration match the description of the span tables. Electrical engineering is beyond our scope. All work performed must be in accordance with accepted industry-wide methods and applicable safety standards. Vector Structural Engineering assumes no responsibility for improper installation of the solar panels.

Very truly yours,

VECTOR STRUCTURAL ENGINEERING, LLC

Jacob Proctor, P.E.
License: 54953 - Expires: 06/30/2022
Project Engineer

Enclosures

JSP/stb



07/06/2020



JOB NO. U2716-0218-201
PROJECT SUNMODO SUNTURF GROUND MOUNTS A8
SUBJECT ALL OPTIONS

651 W GALENA PARK BLVD. #101 (801) 990-1775
DRAPER, UTAH 84020 (801) 990-1776 FAX

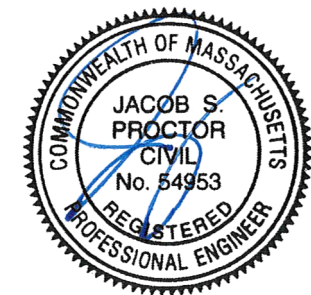
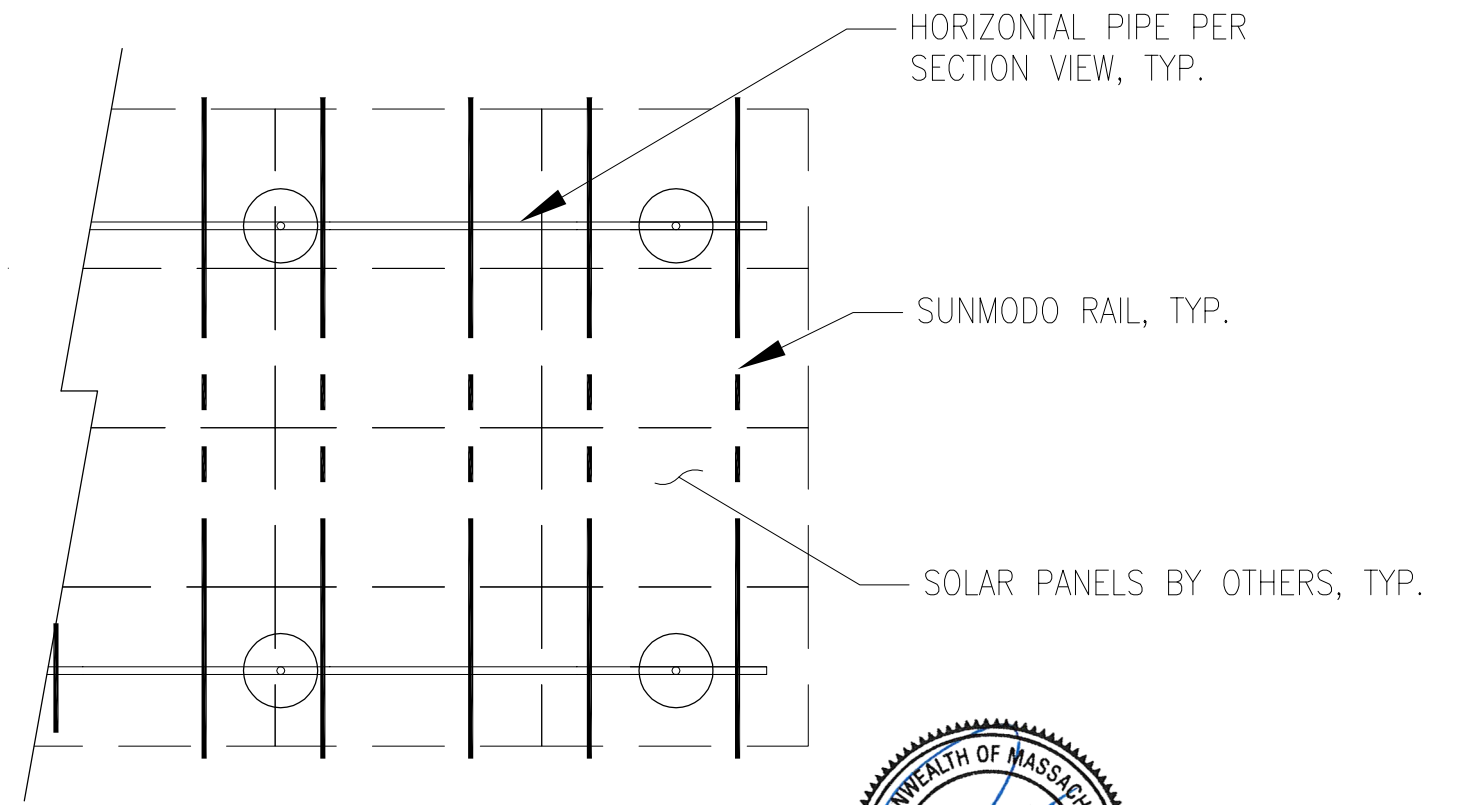
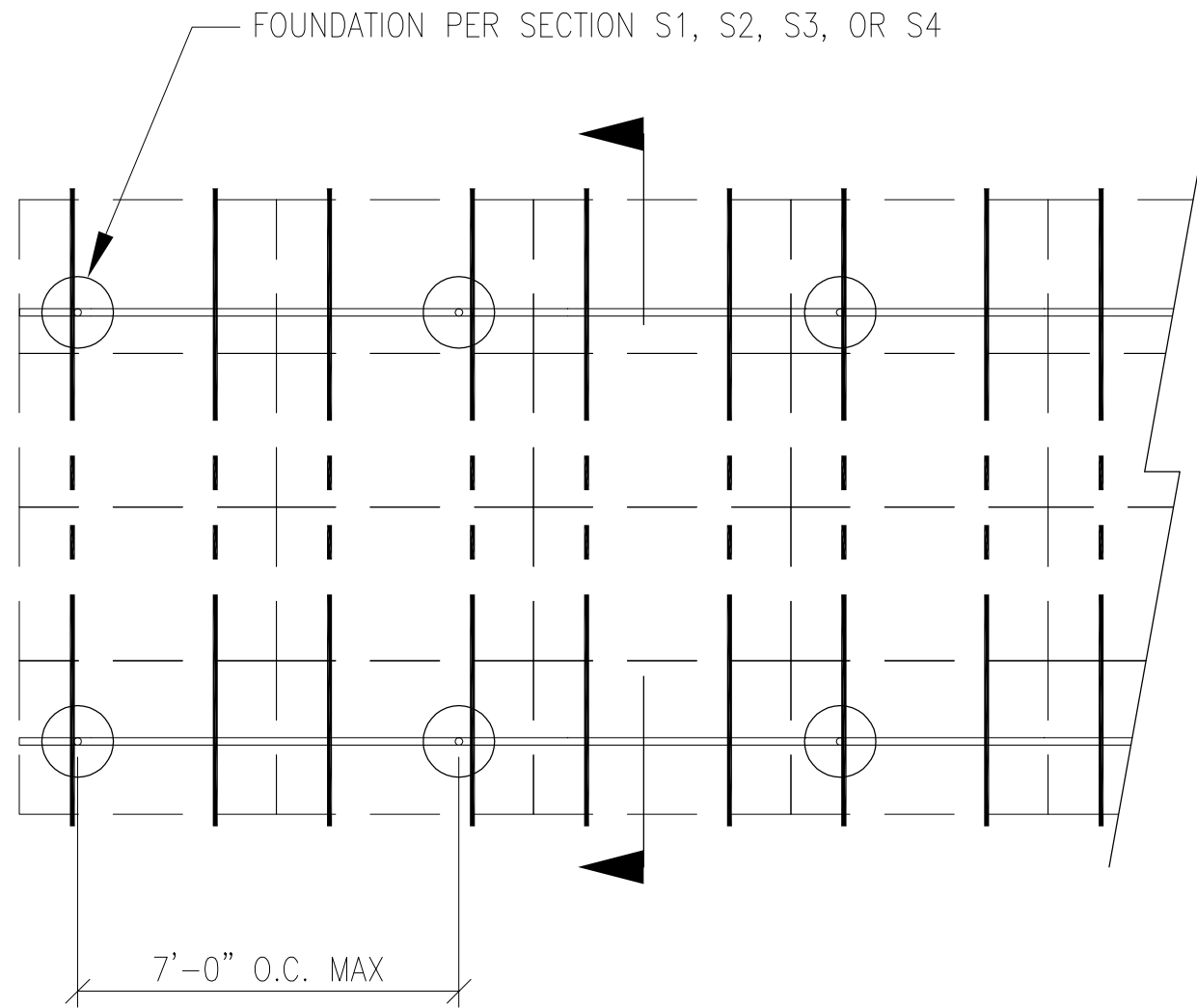

07/06/2020

PV ARRAY PLAN

N.T.S.

P1

PROJECT SUNMODO SUNTURF GROUND MOUNTS A8

SUBJECT DRILLED PIER OPTION

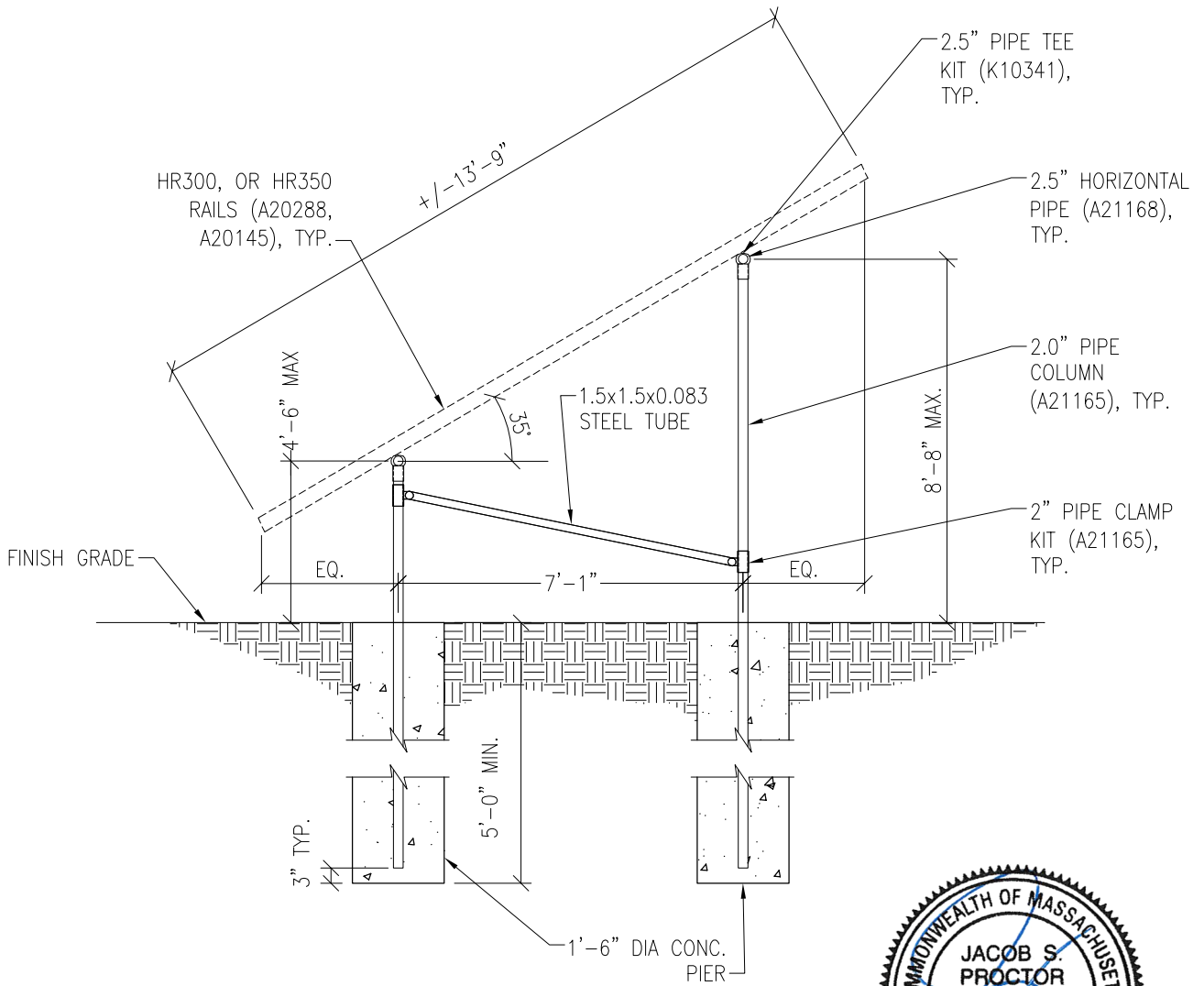

07/06/2020

PV ARRAY SECTION

N.T.S.

S1

PROJECT SUNMODO SUNTURF GROUND MOUNTS A8

SUBJECT HELICAL PIER OPTION

NOTES:

1. For ground mount components see Section S1.
2. A minimum of (1) installed helical pier must be tested as follows:
 - 2.1. Safety factor for uplift to be 1.5
 - 2.2. S.F. for lateral loads to be 2.0
 - 2.3. Upward deflection limit = 1/2"
 - 2.4. Lateral deflection limit = 1"
 - 2.5. The load tests must be performed by an approved contractor

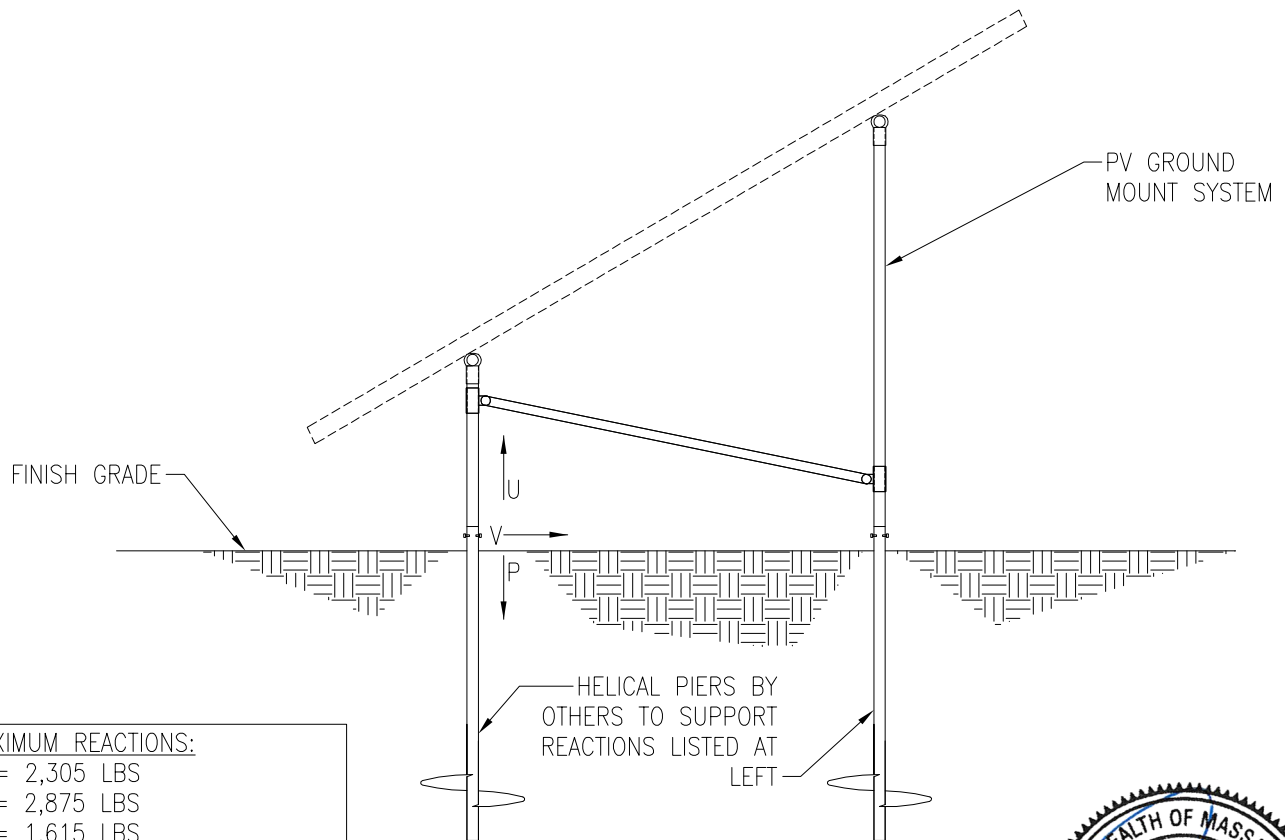

MAXIMUM REACTIONS:
 U = 2,305 LBS
 P = 2,875 LBS
 V = 1,615 LBS



07/06/2020

PV ARRAY SECTION

N.T.S.

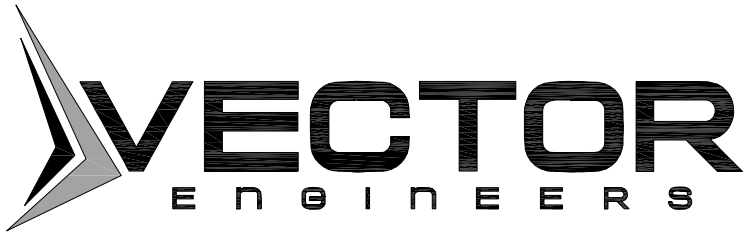

JOB NO. U2716-218-201

PROJECT SUNMODO SUNTURF GROUND MOUNTS A8

SUBJECT GROUND SCREW OPTION

NOTES:

- 1. For ground mount components see Section S1.
- 2. A minimum of (1) installed ground screw must be tested as follows:
 - 2.1. Safety factor for uplift to be 1.5
 - 2.2. S.F. for lateral loads to be 2.0
 - 2.3. Upward deflection limit = 1/2"
 - 2.4. Lateral deflection limit = 1"
 - 2.5. The load tests must be performed by an approved contractor

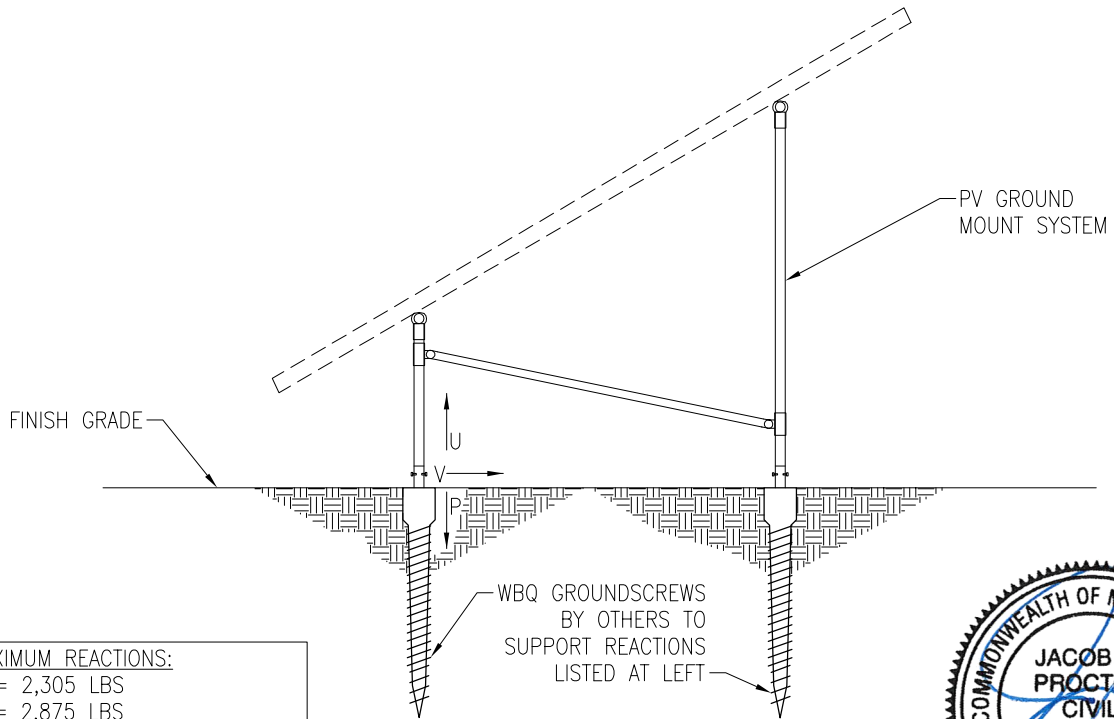

MAXIMUM REACTIONS:
 U = 2,305 LBS
 P = 2,875 LBS
 V = 1,615 LBS



PV ARRAY SECTION

07/06/2020

N.T.S.

S3



JOB NO. U2716-0218-201

PROJECT SUNMODO SUNTURF GROUND MOUNTS A8

SUBJECT BALLASTED BLOCK OPTION

NOTES:

1. For ground mount components see Section S1.

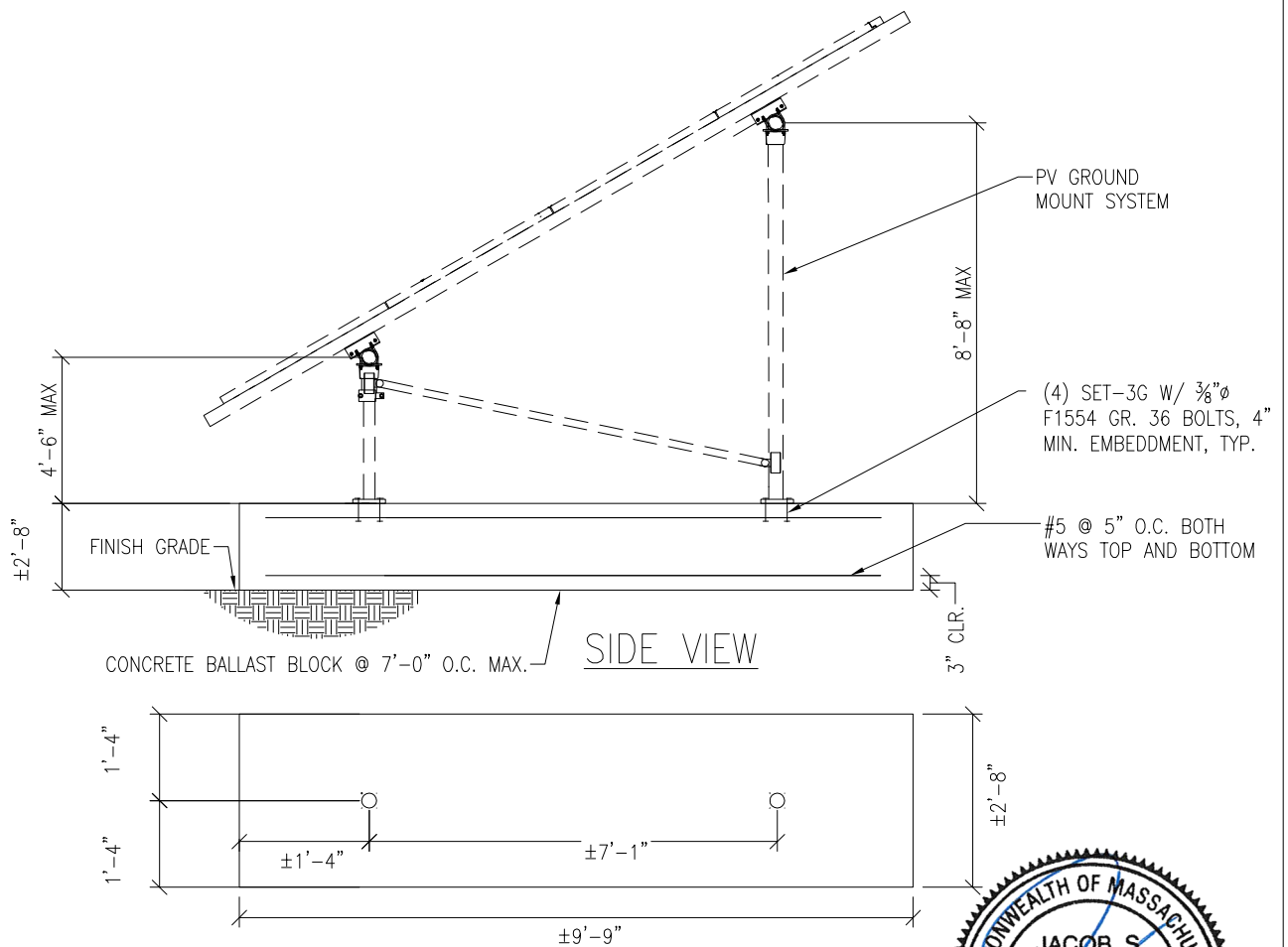

PV ARRAY SECTION

07/06/2020

N.T.S.

S4



JOB NO.: U2716-0218-201

DESIGNED: STB

DATE: 06/25/20

PROJECT: A8 – Sunmodo Sunturf GM

SUBJECT: Snow Load

SNOW LOAD (S):

ASCE 7 Standard:	10	
Panel Slope from Horizontal [°]:	35.0	
Snow Ground Load, p_g [psf]:	50.0	(Section 7.2)
Terrain Category:	C	(Table 7-2)
Exposure of Roof:	Fully Exposed	(Table 7-2)
Exposure Factor, C_e :	0.9	(Table 7-2)
Thermal Factor, C_t :	1.2	(Table 7-3)
Risk Category:	I	(Table 1.5-1)
Importance Factor, I_s :	0.8	(Table 1.5-2)
Flat Roof Snow Load, p_f [psf]:	30	(Equation 7.3-1)
Minimum Roof Snow Load, p_m [psf]:	0	(Section 7.3.4)
Unobstructed Slippery Surface?	Yes	(Section 7.4)
Slope Factor Figure:	Figure 7-2c	(Section 7.4)
Roof Slope Factor, C_s :	0.636	(Figure 7-2)
Sloped Roof Snow Load, p_s [psf]:	19	(Equation 7.4-1)
Design Snow Load, S [psf]:	19	



JOB NO.: U2716-0218-201 DESIGNED: STB
 DATE: 06/25/20

PROJECT: A8 – Sunmodo Sunturf GM

SUBJECT: Wind Pressure

Design Wind Load:

ASCE 7 Standard:	10	
Basic Wind Speed, V [mph]:	115	
Risk Category:	I	
Exposure Category	C	(Section 26.7.3)
Velocity Pressure Exposure Coefficient, K_h :	0.85	(Table 27.3-1)
Topographic Factor, K_{ht} :	1.0	(Section 26.8.2)
Wind Directionality Factor, K_d :	0.85	(Table 26.6-1)
Internal Pressure Coefficient, GC_{pi} :	0.00	(Table 26.11-1)
Velocity Pressure, q_h [psf]:	24.5	(Equation 27.3-1)
Gust Effect Factor, G:	0.85	(Section 26.9.1)
Panel Slope [degrees]:	35.0	

Net Pressure Coefficients (C_N) per: (Figure 27.4-4)

Clear Wind Flow	C_{NW}	C_{NL}
Case 1 ($\gamma = 0^\circ$, Load Case A)	-1.80	-1.80
Case 2 ($\gamma = 0^\circ$, Load Case B)	-2.43	-0.57
Case 3 ($\gamma = 180^\circ$, Load Case A)	2.10	2.17
Case 4 ($\gamma = 180^\circ$, Load Case B)	2.67	1.07

Design Wind Pressures (p) [psf] per: (Equation 27.4-3)

Clear Wind Flow	$q_h GC_{NW}$	$q_h GC_{NL}$
Case 1 ($\gamma = 0^\circ$, Load Case A)	-37.4	-37.4
Case 2 ($\gamma = 0^\circ$, Load Case B)	-50.6	-11.8
Case 3 ($\gamma = 180^\circ$, Load Case A)	43.7	45.0
Case 4 ($\gamma = 180^\circ$, Load Case B)	55.4	22.2



JOB NO.: U2716-0218-201

DESIGNED: STB

Foundation Option 1: Drilled Concrete Pier



PROJECT: A8 – Sunmodo Sunturf GM

Drilled Pier Design

Design Loads:

Max. Shear, V [k]:	1.6	Max. Down, P _d [k]:	2.9
Max. Moment, M [k-ft]:	0.0	Max. Uplift, P _u [k]:	2.3

Pier Properties:

Pier Diameter, b [ft]:	1.5	Volume of Concrete [ft ³]:	9
Min. Pier Diameter, b _{min} (opt'l) [ft]:		Volume of Concrete [yd ³]:	0.3
Top of Pier Elevation [ft]:	0.00	Weight of Concrete [k]:	1.3
Pier Depth, d [ft]:	5.0		
Min. Pier Depth, d _{min} (opt'l) [ft]:			
Max. Pier Depth, d _{max} (opt'l) [ft]:			

Soil Properties:

Allow. Bearing Pressure [psf]:	1,500	<u>Optional Parameters for Uplift:</u>	
1/3 increase for short term loads?	No	Skin Friction [psf]:	250 (IBC 1810.3.3.1.4)
Lateral Bearing, S [pcf]:	150	Top Length to Ignore [ft]:	0.0
Max. Lateral Bearing (opt'l) [psf]:		1/3 increase for short term loads?	No
Top Depth to Ignore [ft]:	0.0	Combine w/ Bearing:	No
1/3 increase for short term loads?	No		
1/2" deflection at t/o pier allowed:	Yes		

Check Bearing:

Bearing Capacity [k]:	5.9	Bearing capacity OK.
-----------------------	-----	-----------------------------

Check Uplift:

Uplift Capacity [k]:	7.1	Uplift capacity OK.
----------------------	-----	----------------------------

Check Lateral Bearing:

Applied Lateral Force, P [lb]:	1,615	
Point of Application, h [ft]:	0.0	
S _{1_max} [psf]:		
S ₁ [psf]:	500	
A = 2.34*P/(S ₁ b):	5.04	
Required Pier Depth, d _{reqd} [ft]:	5.0	Lateral bearing capacity OK.

Foundation Option 2: Helical Pier

- The ground screws and helical piers must be tested to 1.5 times uplift and 2.0 times lateral reactions found in the table below. A minimum of one ground screw or helical pier must be tested.

Load (ASD)	Value (lbs)	Factor of Safety	Test Value (lbs)
UPLIFT	2305	1.5	3460
LATERAL	1615	2	3230

Foundation Option 3: Ground Screw

- The ground screws and helical piers must be tested to 1.5 times uplift and 2.0 times lateral reactions found in the table below. A minimum of one ground screw or helical pier must be tested.

Load (ASD)	Value (lbs)	Factor of Safety	Test Value (lbs)
UPLIFT	2305	1.5	3460
LATERAL	1615	2	3230

Foundation Option 4: Ballasted Block

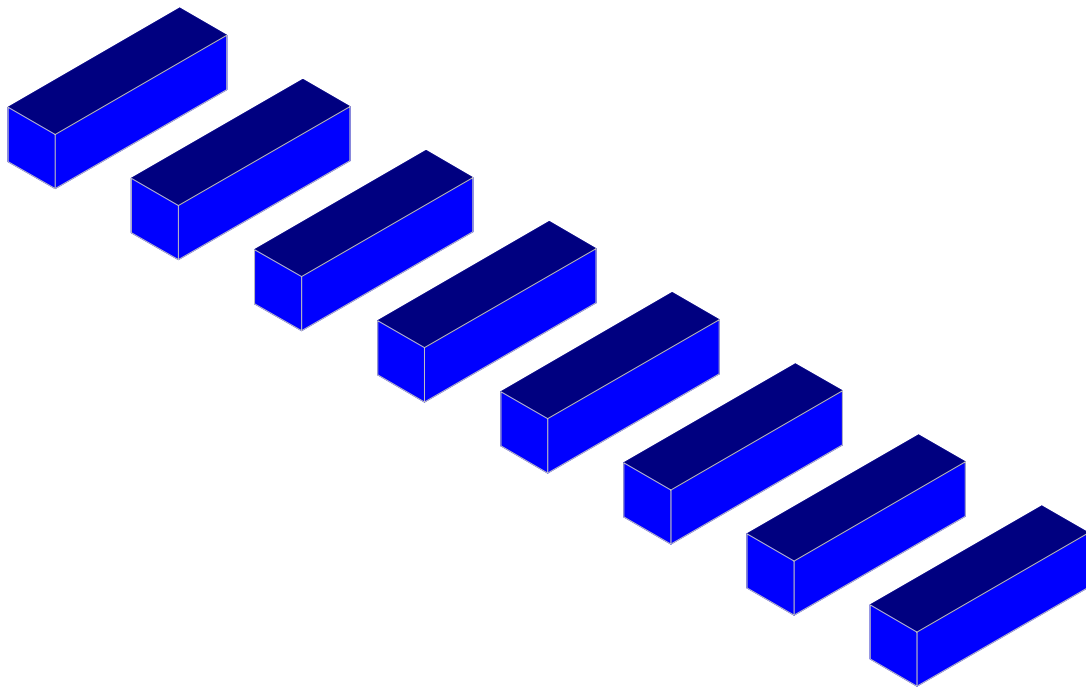

Results for LC 2, 1.0 D

Vector Structural Engineeri..	Ground Mount	SK - 1
STB		June 25, 2020 at 2:50 PM
U2716.0218.201		Sunmodo Sunturf A8.r3d

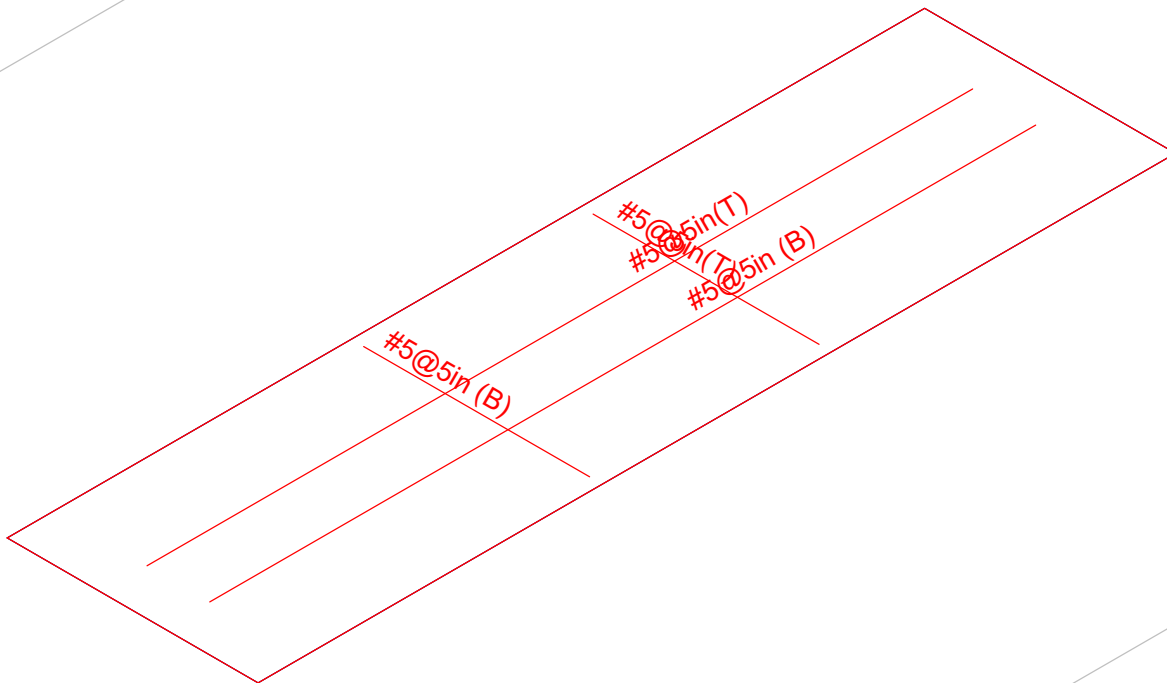

Results for LC 2, 1.0 D

Vector Structural Engineeri..	Ground Mount	SK - 2
STB		June 25, 2020 at 2:50 PM
U2716.0218.201		Sunmodo Sunturf A8.r3d



(Global) Model Settings

Display Sections for Member Calcs	5
Max Internal Sections for Member Calcs	100
Mesh Size (in)	12
Max Iterations	10
Merge Tolerance (in)	.12
Solver	Sparse Accelerated
Coefficient of Friction	.3
No. of Shear Regions	4
Shear Region Spacing Increment (in)	4
Min 1 Bar Dia Spacing for Beams?	No
Optimize footings for OTM / Sliding?	Yes
Parme Beta Factor	.65
Pile Safety Factor	3
Concrete Stress Block	0
Concrete Rebar Set	Rectangular
Concrete Code	ASTM A615
HR Steel Pile Code	ACI 318-14
Wood Pile Code	AISC 14th (360-10): ASD AWC NDS-15: ASD

Concrete Properties

	Label	E [ksi]	G [ksi]	Nu	Therm (/...	Density[k/ft^3]	fc[psi]	Lambda	Flex Stee...	Shear St...
1	Conc3000NW	3156	1372	.15	.6	.145	3000	1	60000	60000
2	Conc3500NW	3409	1482	.15	.6	.145	3500	1	60000	60000
3	Conc4000NW	3644	1584	.15	.6	.145	4000	1	60000	60000
4	Conc3000LW	2085	907	.15	.6	.11	3000	.75	60000	60000
5	Conc3500LW	2252	979	.15	.6	.11	3500	.75	60000	60000
6	Conc4000LW	2408	1047	.15	.6	.11	4000	.75	60000	60000
7	Conc2500NW	3156	1372	.15	.6	.145	2500	1	60000	60000

General Design Parameters

	Label	Max Bending Chk	Max Shear Chk	Top Cover[in]	Bottom Cover[in]
1	Typical	1	1	3	3

Slab Rebar Parameters

	Label	Top Bar	Bottom Bar	Max Top Bar Sp...	Min Top Bar Sp...	Max Bot Bar Sp...	Min Bot Bar Sp...	Spacing Incr...	Rebar Options
1	Typical	#5	#5	18	5	18	5	1	Optimize

Soil Definitions

	Label	Subgrade Modulus[k/ft^3]	Allowable Bearing[psf]	Depth Properties	Default?
1	Default	172.8	1500	None	Yes

Point Loads and Moments (Cat 1 : DL)

	Label	Direction	Magnitude[lb,lb-ft]
1	R3D_N1_1	X	-3.842
2	R3D_N1_1	Y	209.812
3	R3D_N2_1	Y	175.765
4	R3D_N123_1	X	3.941
5	R3D_N123_1	Y	209.061
6	R3D_N124_1	Y	176.377
7	R3D_N123A	Y	225.01
8	R3D_N124A	Y	209.581



Point Loads and Moments (Cat 1 : DL) (Continued)

	Label	Direction	Magnitude[lb,lb-ft]
9	R3D_N129	Y	220.189
10	R3D_N130	Y	207.722
11	R3D_N135	Y	220.687
12	R3D_N136	Y	208.09
13	R3D_N141	Y	220.765
14	R3D_N142	Y	208.047
15	R3D_N147B	Y	219.812
16	R3D_N148A	Y	208.017
17	R3D_N153A	Y	227.292
18	R3D_N154A	Y	207.505

Point Loads and Moments (Cat 6 : RLL)

	Label	Direction	Magnitude[lb,lb-ft]
1	R3D_N1_1	X	-15.325
2	R3D_N1_1	Y	678.014
3	R3D_N1_1	Z	-3.367
4	R3D_N2_1	Y	647.985
5	R3D_N123_1	X	15.771
6	R3D_N123_1	Y	673.993
7	R3D_N123_1	Z	-3.713
8	R3D_N124_1	X	-2.785
9	R3D_N124_1	Y	651.192
10	R3D_N123A	Y	743.201
11	R3D_N123A	Z	2.64
12	R3D_N124A	X	3.358
13	R3D_N124A	Y	788.505
14	R3D_N129	Y	781.618
15	R3D_N130	X	2.062
16	R3D_N130	Y	783.922
17	R3D_N135	Y	778.269
18	R3D_N136	Y	784.392
19	R3D_N141	Y	778.659
20	R3D_N142	Y	784.165
21	R3D_N147B	Y	779.69
22	R3D_N148A	X	-1.858
23	R3D_N148A	Y	785.458
24	R3D_N153A	Y	755.34
25	R3D_N153A	Z	3.333
26	R3D_N154A	X	-1.943
27	R3D_N154A	Y	777.722

Point Loads and Moments (Cat 16 : OL1)

	Label	Direction	Magnitude[lb,lb-ft]
1	R3D_N1_1	X	55.924
2	R3D_N1_1	Y	-3156.067
3	R3D_N1_1	Z	1910.998
4	R3D_N2_1	X	1.429
5	R3D_N2_1	Y	492.566
6	R3D_N2_1	Z	-103.702
7	R3D_N123_1	X	-56.394
8	R3D_N123_1	Y	-3156.283
9	R3D_N123_1	Z	1911.298
10	R3D_N124_1	X	-1.308
11	R3D_N124_1	Y	491.997
12	R3D_N124_1	Z	-103.711
13	R3D_N123A	X	-2.437

Point Loads and Moments (Cat 16 : OL1) (Continued)

	Label	Direction	Magnitude[lb.-ft]
14	R3D_N123A	Y	-3582.428
15	R3D_N123A	Z	2254.216
16	R3D_N124A	X	4.678
17	R3D_N124A	Y	620.916
18	R3D_N124A	Z	-113.097
19	R3D_N129	X	-2.157
20	R3D_N129	Y	-3687.148
21	R3D_N129	Z	2265.39
22	R3D_N130	Y	602.936
23	R3D_N130	Z	-116.12
24	R3D_N135	Y	-3685.469
25	R3D_N135	Z	2269.628
26	R3D_N136	Y	611.547
27	R3D_N136	Z	-116.921
28	R3D_N141	Y	-3685.472
29	R3D_N141	Z	2269.653
30	R3D_N142	Y	611.594
31	R3D_N142	Z	-116.922
32	R3D_N147B	X	2.22
33	R3D_N147B	Y	-3687.575
34	R3D_N147B	Z	2265.486
35	R3D_N148A	Y	603.046
36	R3D_N148A	Z	-116.121
37	R3D_N153A	X	2.459
38	R3D_N153A	Y	-3580.991
39	R3D_N153A	Z	2253.982
40	R3D_N154A	X	-4.618
41	R3D_N154A	Y	620.608
42	R3D_N154A	Z	-113.095

Point Loads and Moments (Cat 17 : OL2)

	Label	Direction	Magnitude[lb.-ft]
1	R3D_N1_1	X	69.324
2	R3D_N1_1	Y	-3487.624
3	R3D_N1_1	Z	1593.322
4	R3D_N2_1	X	5.974
5	R3D_N2_1	Y	1228.619
6	R3D_N2_1	Z	-86.448
7	R3D_N123_1	X	-69.916
8	R3D_N123_1	Y	-3488.262
9	R3D_N123_1	Z	1593.628
10	R3D_N124_1	X	-5.858
11	R3D_N124_1	Y	1228.316
12	R3D_N124_1	Z	-86.457
13	R3D_N123A	X	-3.07
14	R3D_N123A	Y	-3939.684
15	R3D_N123A	Z	1882.219
16	R3D_N124A	X	10.009
17	R3D_N124A	Y	1506.387
18	R3D_N124A	Z	-94.439
19	R3D_N129	X	-2.663
20	R3D_N129	Y	-4062.212
21	R3D_N129	Z	1888.924
22	R3D_N130	X	3.904
23	R3D_N130	Y	1487.948
24	R3D_N130	Z	-96.861

Point Loads and Moments (Cat 17 : OL2) (Continued)

	Label	Direction	Magnitude[lb,lb-ft]
25	R3D_N135	Y	-4059.878
26	R3D_N135	Z	1893.427
27	R3D_N136	X	1.722
28	R3D_N136	Y	1496.626
29	R3D_N136	Z	-97.517
30	R3D_N141	Y	-4059.884
31	R3D_N141	Z	1893.465
32	R3D_N142	X	-1.625
33	R3D_N142	Y	1496.68
34	R3D_N142	Z	-97.518
35	R3D_N147B	X	2.743
36	R3D_N147B	Y	-4062.699
37	R3D_N147B	Z	1889.002
38	R3D_N148A	X	-3.799
39	R3D_N148A	Y	1488.054
40	R3D_N148A	Z	-96.862
41	R3D_N153A	X	3.1
42	R3D_N153A	Y	-3937.99
43	R3D_N153A	Z	1882.008
44	R3D_N154A	X	-9.917
45	R3D_N154A	Y	1506.032
46	R3D_N154A	Z	-94.438

Point Loads and Moments (Cat 18 : OL3)

	Label	Direction	Magnitude[lb,lb-ft]
1	R3D_N1_1	X	-67.076
2	R3D_N1_1	Y	3771.194
3	R3D_N1_1	Z	-2266.087
4	R3D_N2_1	X	-1.855
5	R3D_N2_1	Y	-611.496
6	R3D_N2_1	Z	122.971
7	R3D_N123_1	X	67.64
8	R3D_N123_1	Y	3771.466
9	R3D_N123_1	Z	-2266.445
10	R3D_N124_1	X	1.71
11	R3D_N124_1	Y	-610.828
12	R3D_N124_1	Z	122.981
13	R3D_N123A	X	2.924
14	R3D_N123A	Y	4280.014
15	R3D_N123A	Z	-2673.172
16	R3D_N124A	X	-5.751
17	R3D_N124A	Y	-769.417
18	R3D_N124A	Z	134.117
19	R3D_N129	X	2.586
20	R3D_N129	Y	4405.373
21	R3D_N129	Z	-2686.334
22	R3D_N130	Y	-747.981
23	R3D_N130	Z	137.699
24	R3D_N135	Y	4403.35
25	R3D_N135	Z	-2691.392
26	R3D_N136	Y	-758.242
27	R3D_N136	Z	138.647
28	R3D_N141	Y	4403.355
29	R3D_N141	Z	-2691.422
30	R3D_N142	Y	-758.297
31	R3D_N142	Z	138.648

Point Loads and Moments (Cat 18 : OL3) (Continued)

	Label	Direction	Magnitude[lb.lb-ft]
32	R3D_N147B	X	-2.662
33	R3D_N147B	Y	4405.883
34	R3D_N147B	Z	-2686.448
35	R3D_N148A	Y	-748.112
36	R3D_N148A	Z	137.7
37	R3D_N153A	X	-2.951
38	R3D_N153A	Y	4278.294
39	R3D_N153A	Z	-2672.893
40	R3D_N154A	X	5.679
41	R3D_N154A	Y	-769.048
42	R3D_N154A	Z	134.114

Point Loads and Moments (Cat 19 : OL4)

	Label	Direction	Magnitude[lb.lb-ft]
1	R3D_N1_1	X	-38.619
2	R3D_N1_1	Y	2542.819
3	R3D_N1_1	Z	-1983.284
4	R3D_N2_1	X	2.608
5	R3D_N2_1	Y	188.684
6	R3D_N2_1	Z	107.638
7	R3D_N123_1	X	38.935
8	R3D_N123_1	Y	2542.653
9	R3D_N123_1	Z	-1983.549
10	R3D_N124_1	X	-2.722
11	R3D_N124_1	Y	189.421
12	R3D_N124_1	Z	107.646
13	R3D_N123A	X	1.64
14	R3D_N123A	Y	2902.672
15	R3D_N123A	Z	-2337.148
16	R3D_N124A	Y	201.588
17	R3D_N124A	Z	117.253
18	R3D_N129	X	1.498
19	R3D_N129	Y	2981.22
20	R3D_N129	Z	-2350.978
21	R3D_N130	X	2.444
22	R3D_N130	Y	217.298
23	R3D_N130	Z	120.476
24	R3D_N135	Y	2980.277
25	R3D_N135	Z	-2354.547
26	R3D_N136	Y	209.644
27	R3D_N136	Z	121.315
28	R3D_N141	Y	2980.278
29	R3D_N141	Z	-2354.557
30	R3D_N142	Y	209.608
31	R3D_N142	Z	121.316
32	R3D_N147B	X	-1.54
33	R3D_N147B	Y	2981.551
34	R3D_N147B	Z	-2351.08
35	R3D_N148A	X	-2.49
36	R3D_N148A	Y	217.196
37	R3D_N148A	Z	120.477
38	R3D_N153A	X	-1.653
39	R3D_N153A	Y	2901.605
40	R3D_N153A	Z	-2336.918
41	R3D_N154A	Y	201.824
42	R3D_N154A	Z	117.25

Slabs

	Label	Thickness [in]	Material	Local Axis Angle ...	Analysis Offset [in]	Passive Pressur...	Soil Overburden [psf]
1	S1	32	Conc2500NW	0	0	0	0
2	S2	32	Conc2500NW	0	0	0	0
3	S3	32	Conc2500NW	0	0	0	0
4	S4	32	Conc2500NW	0	0	0	0
5	S5	32	Conc2500NW	0	0	0	0
6	S6	32	Conc2500NW	0	0	0	0
7	S7	32	Conc2500NW	0	0	0	0
8	S8	32	Conc2500NW	0	0	0	0

Load Combinations

	Label	Solve	Service A...	SF	Cat..Fa...	Cat..Fa...	Cat..Fa...	Cat..Fa...	Cat..Fa...	Cat..Fa...	Cat..Fa...	Cat..Fa...	C...	F...	C...	F...
1	ASD Loads															
2	1.0 D	Yes	Yes	1.5	DL 1											
3	1.0 D + 1....	Yes	Yes	1.5	DL 1	RLL 1										
4	1.0 D + 0....	Yes	Yes	1.5	DL 1	RLL	OL1	.6								
5	1.0 D + 0....	Yes	Yes	1.5	DL 1	RLL	OL2	.6								
6	1.0 D + 0....	Yes	Yes	1.5	DL 1	RLL	OL3	.6								
7	1.0 D + 0....	Yes	Yes	1.5	DL 1	RLL	OL4	.6								
8	1.0 D + 0....	Yes	Yes	1.5	DL 1	RLL	.75	OL1	.45							
9	1.0 D + 0....	Yes	Yes	1.5	DL 1	RLL	.75	OL2	.45							
10	1.0 D + 0....	Yes	Yes	1.5	DL 1	RLL	.75	OL3	.45							
11	1.0 D + 0....	Yes	Yes	1.5	DL 1	RLL	.75	OL4	.45							
12	0.6 D + 0....	Yes	Yes		DL .6	RLL	OL1	.6								
13	0.6 D + 0....	Yes	Yes		DL .6	RLL	OL2	.6								
14	0.6 D + 0....	Yes	Yes		DL .6	RLL	OL3	.6								
15	0.6 D + 0....	Yes	Yes		DL .6	RLL	OL4	.6								
16																
17	LRFD Loa...															
18	1.4 D	Yes			DL 1.4	RLL										
19	1.2 D + 1....	Yes			DL 1.2	RLL 1.6	OL1	.5								
20	1.2 D + 1....	Yes			DL 1.2	RLL 1.6	OL2	.5								
21	1.2 D + 1....	Yes			DL 1.2	RLL 1.6	OL3	.5								
22	1.2 D + 1....	Yes			DL 1.2	RLL 1.6	OL4	.5								
23	1.2 D + 1....	Yes			DL 1.2	RLL	OL1	1								
24	1.2 D + 1....	Yes			DL 1.2	RLL	OL2	1								
25	1.2 D + 1....	Yes			DL 1.2	RLL	OL3	1								
26	1.2 D + 1....	Yes			DL 1.2	RLL	OL4	1								
27	0.9 D + 1....	Yes			DL .9	RLL	OL1	1								
28	0.9 D + 1....	Yes			DL .9	RLL	OL2	1								
29	0.9 D + 1....	Yes			DL .9	RLL	OL3	1								
30	0.9 D + 1....	Yes			DL .9	RLL	OL4	1								

Design Strips

	Label	Rebar Angle from Pl...	No. of Design Cuts	Design Rule
1	DS1	0	50	Typical
2	DS2	90	50	Typical

Load Categories

	Category	Point Loads	Line Loads	Area Loads
1	DL	18		
2	RLL	27		
3	OL1	42		
4	OL2	46		
5	OL3	42		
6	OL4	42		



Company : Vector Structural Engineering
 Designer : STB
 Job Number : U2716.0218.201
 Model Name : Ground Mount

June 26, 2020
 9:40 AM
 Checked By: RNE

Strip Reinforcing

	Label	UC Top	LC	Top Bars	Governing ...	UC Bot	LC	Bot B...	Gover...	UC Shear	LC	Governing De...
1	DS1	.01	21	#5@5in	DS1-X25	.011	28	#5@5in	DS1-...	.023	28	DS1-X15
2	DS2	0	27	#5@5in	DS2-X26	.002	21	#5@5in	DS2-...	.005	21	DS2-X25

Slab Overturning Safety Factors

	LC	Slab	Angle[deg]	Mo-xx[lb-ft]	Ms-xx[lb-ft]	Mo-zz[lb-ft]	Ms-zz[lb-ft]	Ms-xx/Mo-xx	Ms-zz/Mo-zz
1	2	S1	0	0	50769.271	0	13928.815	9.999+	9.999+
2	2	S2	0	0	51074.156	0	13983.923	9.999+	9.999+
3	2	S3	0	0	51052.082	0	13975.016	9.999+	9.999+
4	2	S4	0	0	51055.842	0	13976.171	9.999+	9.999+
5	2	S5	0	0	51055.581	0	13976.216	9.999+	9.999+
6	2	S6	0	0	51054.058	0	13974.906	9.999+	9.999+
7	2	S7	0	0	51059.721	0	13984.197	9.999+	9.999+
8	2	S8	0	0	50773.421	0	13907.876	9.999+	9.999+
9	3	S1	0	0	57118.183	0	15737.681	9.999+	9.999+
10	3	S2	0	0	58708.711	0	16017.243	9.999+	9.999+
11	3	S3	0	0	58692.248	0	16056.904	9.999+	9.999+
12	3	S4	0	0	58695.492	0	16059.719	9.999+	9.999+
13	3	S5	0	0	58693.838	0	16059.981	9.999+	9.999+
14	3	S6	0	0	58704.576	0	16066.724	9.999+	9.999+
15	3	S7	0	0	58621.548	0	16033.46	9.999+	9.999+
16	3	S8	0	0	57143.038	0	15640.16	9.999+	9.999+
17	4	S1	0	18435.79	51010.444	2222.567	13928.815	2.767	6.267
18	4	S2	0	21020.355	51183.454	2372.794	13983.923	2.435	5.893
19	4	S3	0	21576.619	51140.399	2470.82	13975.016	2.37	5.656
20	4	S4	0	21566.751	51145.083	2459.137	13976.171	2.371	5.683
21	4	S5	0	21566.769	51145.674	2459.103	13976.216	2.372	5.683
22	4	S6	0	21578.837	51137.614	2471.174	13974.906	2.37	5.655
23	4	S7	0	21012.974	51199.891	2371.761	13984.197	2.437	5.896
24	4	S8	0	18437.804	51004.945	2223.751	13928.895	2.766	6.264
25	5	S1	0	19040.633	51010.444	1927.681	13928.815	2.679	7.226
26	5	S2	0	21550.775	51183.454	1957.74	13983.923	2.375	7.143
27	5	S3	0	22191.146	51140.399	2061.397	13975.016	2.305	6.779
28	5	S4	0	22178.568	51145.083	2053.357	13976.171	2.306	6.806
29	5	S5	0	22178.619	51145.674	2053.164	13976.216	2.306	6.807
30	5	S6	0	22193.644	51137.614	2061.406	13974.906	2.304	6.779
31	5	S7	0	21542.167	51199.891	1956.473	13984.197	2.377	7.148
32	5	S8	0	19044.57	51004.945	1929.194	13928.895	2.678	7.22
33	6	S1	0	3500.094	50769.271	0	16566.864	9.999+	9.999+
34	6	S2	0	4524.041	51074.156	0	16796.924	9.999+	9.999+
35	6	S3	0	4330.83	51052.082	0	16896.792	9.999+	9.999+
36	6	S4	0	4390.842	51055.842	0	16892.258	9.999+	9.999+
37	6	S5	0	4391.165	51055.581	0	16892.262	9.999+	9.999+
38	6	S6	0	4331.264	51054.058	0	16905.382	9.999+	9.999+
39	6	S7	0	4523.115	51059.721	0	16787.228	9.999+	9.999+
40	6	S8	0	3497.056	50773.421	0	16325.426	9.999+	9.999+
41	7	S1	0	13.93	50769.271	0	16171.636	9.999+	9.999+
42	7	S2	0	211.684	51074.156	0	16464.706	9.999+	9.999+
43	7	S3	0	86.483	51052.082	0	16527.523	9.999+	9.999+
44	7	S4	0	130.256	51055.842	0	16528.108	9.999+	9.999+
45	7	S5	0	130.452	51055.581	0	16528.125	9.999+	9.999+
46	7	S6	0	86.894	51054.058	0	16540.352	9.999+	9.999+
47	7	S7	0	210.982	51059.721	0	16469.585	9.999+	9.999+
48	7	S8	0	10.752	50773.421	0	16035.595	9.999+	9.999+
49	8	S1	0	13826.843	55945.148	1666.925	15285.465	4.046	9.17
50	8	S2	0	15765.266	56658.158	1779.596	15508.913	3.594	8.715
51	8	S3	0	16182.464	56858.31	1853.115	15544.682	3.514	8.388



Slab Overturning Safety Factors (Continued)

LC	Slab	Angle[deg]	Mo-xx[lb-ft]	Ms-xx[lb-ft]	Mo-zz[lb-ft]	Ms-zz[lb-ft]	Ms-xx/Mo-xx	Ms-zz/Mo-zz	
52	8	S4	0	16175.063	56842.323	1844.353	15538.832	3.514	8.425
53	8	S5	0	16175.077	56845.148	1844.327	15539.04	3.514	8.425
54	8	S6	0	16184.128	56844.89	1853.381	15543.77	3.512	8.387
55	8	S7	0	15759.731	56739.058	1778.82	15513.373	3.6	8.721
56	8	S8	0	13828.353	55918.164	1667.813	15280.051	4.044	9.162
57	9	S1	0	14280.475	55945.148	1445.761	15285.465	3.918	9.999+
58	9	S2	0	16163.081	56658.158	1468.305	15508.913	3.505	9.999+
59	9	S3	0	16643.359	56858.31	1546.048	15536.432	3.416	9.999+
60	9	S4	0	16633.926	56842.323	1540.018	15538.832	3.417	9.999+
61	9	S5	0	16633.964	56845.148	1539.873	15539.04	3.417	9.999+
62	9	S6	0	16645.233	56844.89	1546.054	15536.338	3.415	9.999+
63	9	S7	0	16156.625	56739.058	1467.355	15513.373	3.512	9.999+
64	9	S8	0	14283.428	55918.164	1446.896	15280.051	3.915	9.999+
65	10	S1	0	2625.071	55530.955	0	17264.001	9.999+	9.999+
66	10	S2	0	3393.031	56800.072	0	17618.663	9.999+	9.999+
67	10	S3	0	3248.123	56782.206	0	17727.764	9.999+	9.999+
68	10	S4	0	3293.131	56785.58	0	17725.897	9.999+	9.999+
69	10	S5	0	3293.374	56784.274	0	17726.074	9.999+	9.999+
70	10	S6	0	3248.448	56791.947	0	17741.627	9.999+	9.999+
71	10	S7	0	3392.336	56731.091	0	17623.418	9.999+	9.999+
72	10	S8	0	2622.792	55550.634	0	17020.252	9.999+	9.999+
73	11	S1	0	10.447	55530.955	0	16967.58	9.999+	9.999+
74	11	S2	0	158.763	56800.072	0	17369.5	9.999+	9.999+
75	11	S3	0	64.862	56782.206	0	17450.812	9.999+	9.999+
76	11	S4	0	97.692	56785.58	0	17452.785	9.999+	9.999+
77	11	S5	0	97.839	56784.274	0	17452.971	9.999+	9.999+
78	11	S6	0	65.171	56791.947	0	17467.854	9.999+	9.999+
79	11	S7	0	158.236	56731.091	0	17385.186	9.999+	9.999+
80	11	S8	0	8.064	55550.634	0	16802.878	9.999+	9.999+
81	12	S1	0	18435.79	30606.266	2222.567	8357.289	1.66	3.76
82	12	S2	0	21020.355	30710.073	2372.794	8390.354	1.461	3.536
83	12	S3	0	21576.619	30684.239	2470.82	8385.01	1.422	3.394
84	12	S4	0	21566.751	30687.05	2459.137	8385.703	1.423	3.41
85	12	S5	0	21566.769	30687.404	2459.103	8385.73	1.423	3.41
86	12	S6	0	21578.837	30682.568	2471.174	8384.943	1.422	3.393
87	12	S7	0	21012.974	30719.935	2371.761	8390.518	1.462	3.538
88	12	S8	0	18437.804	30602.967	2223.751	8357.337	1.66	3.758
89	13	S1	0	19040.633	30606.266	1927.681	8357.289	1.607	4.335
90	13	S2	0	21550.775	30710.073	1957.74	8390.354	1.425	4.286
91	13	S3	0	22191.146	30684.239	2061.397	8385.01	1.383	4.068
92	13	S4	0	22178.568	30687.05	2053.357	8385.703	1.384	4.084
93	13	S5	0	22178.619	30687.404	2053.164	8385.73	1.384	4.084
94	13	S6	0	22193.644	30682.568	2061.406	8384.943	1.382	4.068
95	13	S7	0	21542.167	30719.935	1956.473	8390.518	1.426	4.289
96	13	S8	0	19044.57	30602.967	1929.194	8357.337	1.607	4.332
97	14	S1	0	3500.094	30461.563	0	10995.338	8.703	9.999+
98	14	S2	0	4524.041	30644.494	0	11203.354	6.774	9.999+
99	14	S3	0	4330.83	30631.249	0	11306.785	7.073	9.999+
100	14	S4	0	4390.842	30633.505	0	11301.79	6.977	9.999+
101	14	S5	0	4391.165	30633.348	0	11301.776	6.976	9.999+
102	14	S6	0	4331.264	30632.435	0	11315.42	7.072	9.999+
103	14	S7	0	4523.115	30635.832	0	11193.549	6.773	9.999+
104	14	S8	0	3497.056	30464.053	0	10762.276	8.711	9.999+
105	15	S1	0	13.93	30461.563	0	10600.11	9.999+	9.999+
106	15	S2	0	211.684	30644.494	0	10871.136	9.999+	9.999+
107	15	S3	0	86.483	30631.249	0	10937.516	9.999+	9.999+
108	15	S4	0	130.256	30633.505	0	10937.64	9.999+	9.999+



Company : Vector Structural Engineering
 Designer : STB
 Job Number : U2716.0218.201
 Model Name : Ground Mount

June 26, 2020
 9:40 AM
 Checked By: RNE

Slab Overturning Safety Factors (Continued)

	LC	Slab	Angle[deg]	Mo-xx[lb-ft]	Ms-xx[lb-ft]	Mo-zz[lb-ft]	Ms-zz[lb-ft]	Ms-xx/Mo-xx	Ms-zz/Mo-zz
109	15	S5	0	130.452	30633.348	0	10937.638	9.999+	9.999+
110	15	S6	0	86.894	30632.435	0	10950.389	9.999+	9.999+
111	15	S7	0	210.982	30635.832	0	10875.906	9.999+	9.999+
112	15	S8	0	10.752	30464.053	0	10472.444	9.999+	9.999+

Slab Sliding Safety Factors

	LC	Slab	Angle[deg]	Va-xx[lb]	Vr-xx[lb]	Va-zz[lb]	Vr-zz[lb]	SR-xx	SR-zz
1	2	S1	0	3.842	3131.678	0	3131.678	9.999+	9.999+
2	2	S2	0	0	3146.383	0	3146.383	9.999+	9.999+
3	2	S3	0	0	3144.379	0	3144.379	9.999+	9.999+
4	2	S4	0	0	3144.638	0	3144.638	9.999+	9.999+
5	2	S5	0	0	3144.649	0	3144.649	9.999+	9.999+
6	2	S6	0	0	3144.354	0	3144.354	9.999+	9.999+
7	2	S7	0	0	3146.444	0	3146.444	9.999+	9.999+
8	2	S8	0	3.941	3131.637	0	3131.637	9.999+	9.999+
9	3	S1	0	19.167	3529.478	3.367	3529.478	9.999+	9.999+
10	3	S2	0	3.358	3605.894	2.64	3605.894	9.999+	9.999+
11	3	S3	0	2.062	3614.041	0	3614.041	9.999+	9.999+
12	3	S4	0	0	3613.437	0	3613.437	9.999+	9.999+
13	3	S5	0	0	3613.496	0	3613.496	9.999+	9.999+
14	3	S6	0	1.858	3613.898	0	3613.898	9.999+	9.999+
15	3	S7	0	1.943	3606.363	3.333	3606.363	9.999+	9.999+
16	3	S8	0	16.927	3529.192	3.713	3529.192	9.999+	9.999+
17	4	S1	0	30.57	2652.248	1084.377	2652.248	9.999+	2.446
18	4	S2	0	1.344	2613.311	1284.671	2613.311	9.999+	2.034
19	4	S3	0	1.294	2589.221	1289.562	2589.221	9.999+	2.008
20	4	S4	0	0	2591.333	1291.625	2591.333	9.999+	2.006
21	4	S5	0	0	2591.35	1291.639	2591.35	9.999+	2.006
22	4	S6	0	1.332	2589.139	1289.619	2589.139	9.999+	2.008
23	4	S7	0	1.295	2613.575	1284.532	2613.575	9.999+	2.035
24	4	S8	0	30.68	2652.065	1084.552	2652.065	9.999+	2.445
25	5	S1	0	41.337	2725.057	904.124	2725.057	9.999+	3.014
26	5	S2	0	4.163	2708.389	1072.668	2708.389	9.999+	2.525
27	5	S3	0	.745	2681.011	1075.238	2681.011	9.999+	2.493
28	5	S4	0	1.033	2683.253	1077.546	2683.253	9.999+	2.49
29	5	S5	0	.975	2683.272	1077.568	2683.272	9.999+	2.49
30	5	S6	0	.634	2680.918	1075.284	2680.918	9.999+	2.493
31	5	S7	0	4.09	2708.692	1072.542	2708.692	9.999+	2.525
32	5	S8	0	41.523	2724.846	904.302	2724.846	9.999+	3.013
33	6	S1	0	45.201	3700.424	1285.869	3700.424	9.999+	2.878
34	6	S2	0	1.696	3778.29	1523.433	3778.29	9.999+	2.48
35	6	S3	0	1.552	3802.709	1529.181	3802.709	9.999+	2.487
36	6	S4	0	0	3800.758	1531.647	3800.758	9.999+	2.481
37	6	S5	0	0	3800.759	1531.664	3800.759	9.999+	2.481
38	6	S6	0	1.597	3802.753	1529.249	3802.753	9.999+	2.487
39	6	S7	0	1.637	3778.108	1523.268	3778.108	9.999+	2.48
40	6	S8	0	45.551	3700.552	1286.078	3700.552	9.999+	2.877
41	7	S1	0	25.449	3623.349	1125.388	3623.349	9.999+	3.22
42	7	S2	0	.984	3705.149	1331.937	3705.149	9.999+	2.782
43	7	S3	0	2.365	3720.112	1338.301	3720.112	9.999+	2.78
44	7	S4	0	0	3718.824	1339.939	3718.824	9.999+	2.775
45	7	S5	0	0	3718.828	1339.945	3718.828	9.999+	2.775
46	7	S6	0	2.418	3720.128	1338.362	3720.128	9.999+	2.78
47	7	S7	0	.992	3705.061	1331.8	3705.061	9.999+	2.782
48	7	S8	0	25.669	3623.41	1125.542	3623.41	9.999+	3.219
49	8	S1	0	10.473	3070.455	810.758	3070.455	9.999+	3.787



Slab Sliding Safety Factors (Continued)

	LC	Slab	Angle[deg]	Va-xx[lb]	Vr-xx[lb]	Va-zz[lb]	Vr-zz[lb]	SR-xx	SR-zz
50	8	S2	0	3.527	3091.212	965.484	3091.212	9.999+	3.202
51	8	S3	0	.576	3080.257	967.171	3080.257	9.999+	3.185
52	8	S4	0	0	3081.258	968.718	3081.258	9.999+	3.181
53	8	S5	0	0	3081.31	968.729	3081.31	9.999+	3.181
54	8	S6	0	.395	3080.101	967.214	3080.101	9.999+	3.185
55	8	S7	0	2.429	3091.732	965.899	3091.732	9.999+	3.201
56	8	S8	0	12.285	3070.125	810.629	3070.125	9.999+	3.787
57	9	S1	0	18.548	3125.062	675.568	3125.062	9.999+	4.626
58	9	S2	0	5.641	3162.521	806.481	3162.521	9.999+	3.921
59	9	S3	0	2.105	3149.1	806.428	3149.1	9.999+	3.905
60	9	S4	0	.775	3150.198	808.159	3150.198	9.999+	3.898
61	9	S5	0	.731	3150.251	808.176	3150.251	9.999+	3.898
62	9	S6	0	1.869	3148.935	806.463	3148.935	9.999+	3.905
63	9	S7	0	4.525	3163.069	806.906	3163.069	9.999+	3.92
64	9	S8	0	20.418	3124.711	675.442	3124.711	9.999+	4.626
65	10	S1	0	46.355	3856.587	966.927	3856.587	9.999+	3.988
66	10	S2	0	1.246	3964.947	1140.594	3964.947	9.999+	3.476
67	10	S3	0	2.711	3990.373	1146.886	3990.373	9.999+	3.479
68	10	S4	0	0	3988.327	1148.735	3988.327	9.999+	3.472
69	10	S5	0	0	3988.367	1148.748	3988.367	9.999+	3.472
70	10	S6	0	2.591	3990.311	1146.937	3990.311	9.999+	3.479
71	10	S7	0	.229	3965.131	1139.951	3965.131	9.999+	3.478
72	10	S8	0	44.888	3856.489	967.343	3856.489	9.999+	3.987
73	11	S1	0	31.541	3798.781	846.566	3798.781	9.999+	4.487
74	11	S2	0	3.257	3910.092	996.972	3910.092	9.999+	3.922
75	11	S3	0	3.321	3928.425	1003.726	3928.425	9.999+	3.914
76	11	S4	0	0	3926.877	1004.954	3926.877	9.999+	3.908
77	11	S5	0	0	3926.918	1004.959	3926.918	9.999+	3.908
78	11	S6	0	3.207	3928.343	1003.771	3928.343	9.999+	3.914
79	11	S7	0	2.201	3910.346	996.351	3910.346	9.999+	3.925
80	11	S8	0	29.976	3798.633	846.941	3798.633	9.999+	4.485
81	12	S1	0	32.107	1399.577	1084.377	1399.577	9.999+	1.291
82	12	S2	0	1.344	1354.758	1284.671	1354.758	9.999+	1.055
83	12	S3	0	1.294	1331.469	1289.562	1331.469	9.999+	1.032
84	12	S4	0	0	1333.477	1291.625	1333.477	9.999+	1.032
85	12	S5	0	0	1333.491	1291.639	1333.491	9.999+	1.032
86	12	S6	0	1.332	1331.397	1289.619	1331.397	9.999+	1.032
87	12	S7	0	1.295	1354.998	1284.532	1354.998	9.999+	1.055
88	12	S8	0	32.256	1399.411	1084.552	1399.411	9.999+	1.29
89	13	S1	0	42.874	1472.386	904.124	1472.386	9.999+	1.629
90	13	S2	0	4.163	1449.836	1072.668	1449.836	9.999+	1.352
91	13	S3	0	.745	1423.26	1075.238	1423.26	9.999+	1.324
92	13	S4	0	1.033	1425.398	1077.546	1425.398	9.999+	1.323
93	13	S5	0	.975	1425.412	1077.568	1425.412	9.999+	1.323
94	13	S6	0	.634	1423.176	1075.284	1423.176	9.999+	1.324
95	13	S7	0	4.09	1450.114	1072.542	1450.114	9.999+	1.352
96	13	S8	0	43.1	1472.192	904.302	1472.192	9.999+	1.628
97	14	S1	0	43.664	2447.752	1285.869	2447.752	9.999+	1.904
98	14	S2	0	1.696	2519.737	1523.433	2519.737	9.999+	1.654
99	14	S3	0	1.552	2544.958	1529.181	2544.958	9.999+	1.664
100	14	S4	0	0	2542.903	1531.647	2542.903	9.999+	1.66
101	14	S5	0	0	2542.899	1531.664	2542.899	9.999+	1.66
102	14	S6	0	1.597	2545.011	1529.249	2545.011	9.999+	1.664
103	14	S7	0	1.637	2519.531	1523.268	2519.531	9.999+	1.654
104	14	S8	0	43.975	2447.897	1286.078	2447.897	9.999+	1.903
105	15	S1	0	23.912	2370.678	1125.388	2370.678	9.999+	2.107
106	15	S2	0	.984	2446.596	1331.937	2446.596	9.999+	1.837



Slab Sliding Safety Factors (Continued)

	LC	Slab	Angle[deg]	Va-xx[lb]	Vr-xx[lb]	Va-zz[lb]	Vr-zz[lb]	SR-xx	SR-zz
107	15	S3	0	2.365	2462.36	1338.301	2462.36	9.999+	1.84
108	15	S4	0	0	2460.969	1339.939	2460.969	9.999+	1.837
109	15	S5	0	0	2460.969	1339.945	2460.969	9.999+	1.837
110	15	S6	0	2.418	2462.387	1338.362	2462.387	9.999+	1.84
111	15	S7	0	.992	2446.484	1331.8	2446.484	9.999+	1.837
112	15	S8	0	24.092	2370.755	1125.542	2370.755	9.999+	2.106

Envelope Slab Soil Pressures

	Label	UC	LC	Soil Pressure[psf]	Allowable Bearing[psf]	Point
1	S1	.463	6	693.919	1500	N226
2	S2	.49	6	735.315	1500	N233
3	S3	.496	6	743.349	1500	N240
4	S4	.496	6	743.514	1500	N247
5	S5	.496	6	743.527	1500	N254
6	S6	.496	6	743.331	1500	N261
7	S7	.49	6	735.547	1500	N268
8	S8	.463	6	693.804	1500	N275



Company:		Date:	5/14/2018
Engineer:		Page:	1/6
Project:			
Address:			
Phone:			
E-mail:			

1. Project information

Customer company:
Customer contact name:
Customer e-mail:
Comment:

Project description:
Location:
Fastening description:

2. Input Data & Anchor Parameters

General

Design method: ACI 318-14
Units: Imperial units

Anchor Information:

Anchor type: Bonded anchor
Material: F1554 Grade 36
Diameter (inch): 0.375
Effective Embedment depth, h_{ef} (inch): 4.000
Code report: ICC-ES ESR-4057
Anchor category: -
Anchor ductility: Yes
 h_{min} (inch): 5.25
 c_{ac} (inch): 7.12
 c_{min} (inch): 1.75
 s_{min} (inch): 3.00

Base Material

Concrete: Normal-weight
Concrete thickness, h (inch): 33.00
State: Cracked
Compressive strength, f'_c (psi): 2500
 $\Psi_{c,v}$: 1.0
Reinforcement condition: B tension, B shear
Supplemental reinforcement: Not applicable
Reinforcement provided at corners: No
Ignore concrete breakout in tension: No
Ignore concrete breakout in shear: No
Hole condition: Dry concrete
Inspection: Periodic
Temperature range, Short/Long: 150/110°F
Ignore 6do requirement: Not applicable
Build-up grout pad: No

Base Plate

Length x Width x Thickness (inch): 4.75 x 4.75 x 0.31

Recommended Anchor

Anchor Name: SET-3G - SET-3G w/ 3/8"Ø F1554 Gr. 36
Code Report: ICC-ES ESR-4057





Company:		Date:	5/14/2018
Engineer:		Page:	2/6
Project:			
Address:			
Phone:			
E-mail:			

Load and Geometry

Load factor source: ACI 318 Section 5.3

Load combination: not set

Seismic design: No

Anchors subjected to sustained tension: No

Apply entire shear load at front row: No

Anchors only resisting wind and/or seismic loads: No

Strength level loads:

N_{ua} [lb]: 3855

V_{uax} [lb]: 250

V_{uay} [lb]: -2695

M_{ux} [ft-lb]: 0

M_{uy} [ft-lb]: 0

M_{uz} [ft-lb]: 0

<Figure 1>

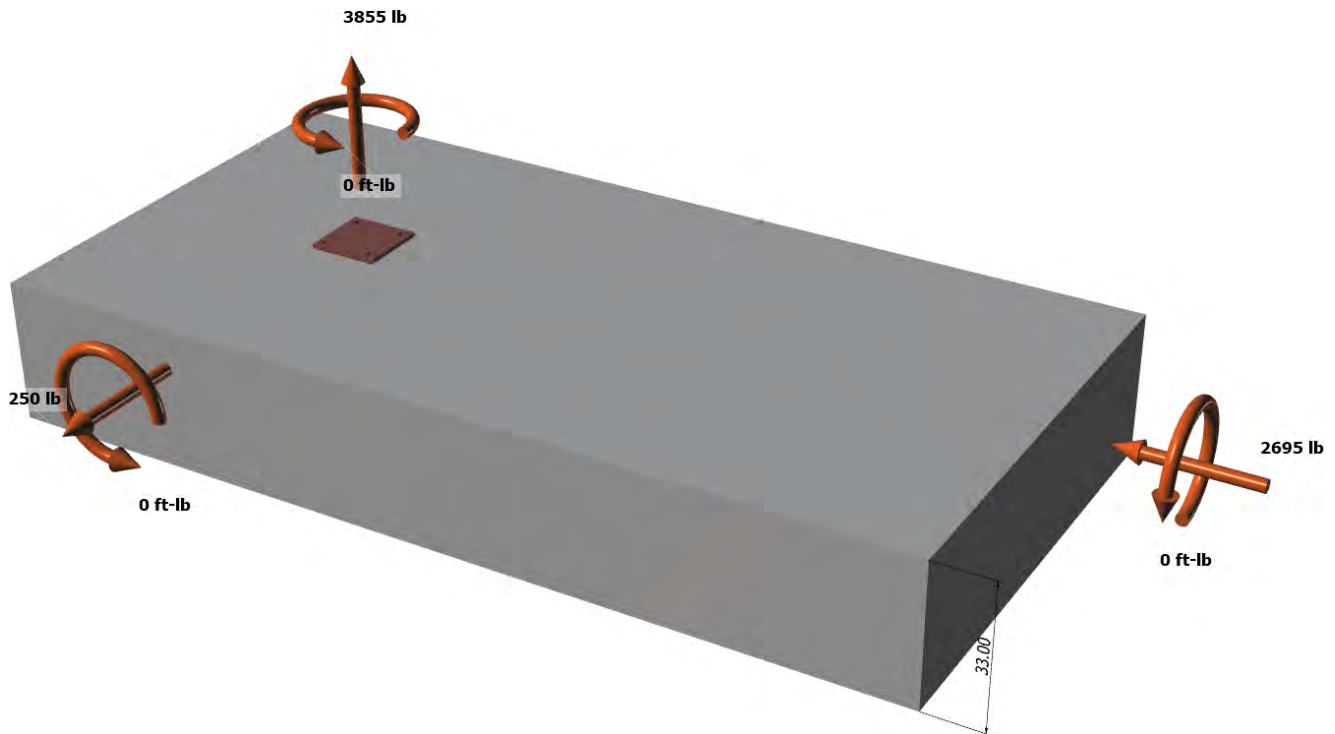



Company:		Date:	5/14/2018
Engineer:		Page:	3/6
Project:			
Address:			
Phone:			
E-mail:			

<Figure 2>

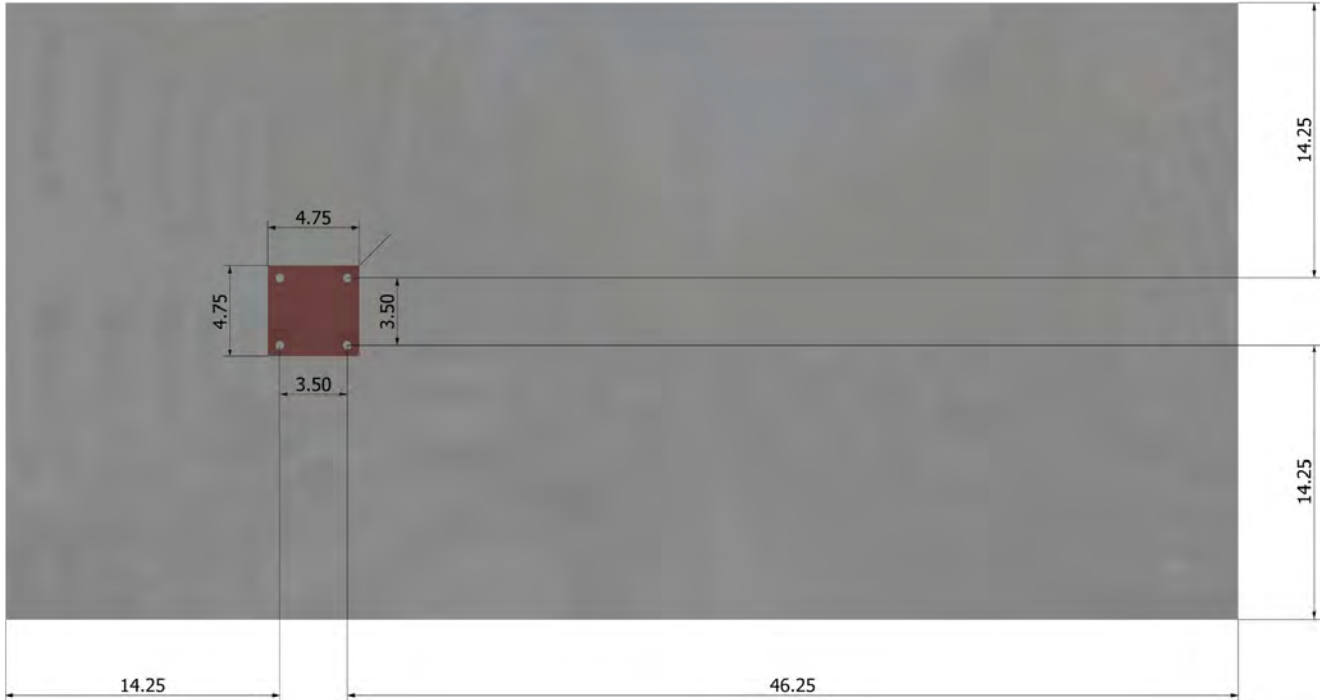



Company:		Date:	5/14/2018
Engineer:		Page:	4/6
Project:			
Address:			
Phone:			
E-mail:			

3. Resulting Anchor Forces

Anchor	Tension load, N _{ua} (lb)	Shear load x, V _{uax} (lb)	Shear load y, V _{uay} (lb)	Shear load combined, $\sqrt{(V_{uax})^2 + (V_{uay})^2}$ (lb)
1	963.8	62.5	-673.8	676.6
2	963.8	62.5	-673.8	676.6
3	963.8	62.5	-673.8	676.6
4	963.8	62.5	-673.8	676.6
Sum	3855.0	250.0	-2695.0	2706.6

Maximum concrete compression strain (%): 0.00
 Maximum concrete compression stress (psi): 0
 Resultant tension force (lb): 3855
 Resultant compression force (lb): 0
 Eccentricity of resultant tension forces in x-axis, e'_{Nx} (inch): 0.00
 Eccentricity of resultant tension forces in y-axis, e'_{Ny} (inch): 0.00
 Eccentricity of resultant shear forces in x-axis, e'_{Vx} (inch): 0.00
 Eccentricity of resultant shear forces in y-axis, e'_{Vy} (inch): 0.00

<Figure 3>

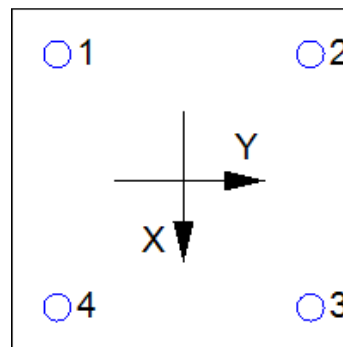

4. Steel Strength of Anchor in Tension (Sec. 17.4.1)

N _{sa} (lb)	φ	φN _{sa} (lb)
4525	0.75	3394

5. Concrete Breakout Strength of Anchor in Tension (Sec. 17.4.2)

$$N_b = K_c \lambda_a \sqrt{f_c} h_{ef}^{1.5} \text{ (Eq. 17.4.2.2a)}$$

K _c	λ _a	f _c (psi)	h _{ef} (in)	N _b (lb)
17.0	1.00	2500	4.000	6800

$$\phi N_{cbg} = \phi (A_{Nc} / A_{Nco}) \psi_{ec,N} \psi_{ed,N} \psi_{c,N} \psi_{cp,N} N_b \text{ (Sec. 17.3.1 \& Eq. 17.4.2.1b)}$$

A _{Nc} (in ²)	A _{Nco} (in ²)	c _{a,min} (in)	ψ _{ec,N}	ψ _{ed,N}	ψ _{c,N}	ψ _{cp,N}	N _b (lb)	φ	φN _{cbg} (lb)
240.25	144.00	14.25	1.000	1.000	1.00	1.000	6800	0.65	7374

6. Adhesive Strength of Anchor in Tension (Sec. 17.4.5)

$$\tau_{k,cr} = \tau_{k,cr,short-term} K_{sat} (f_c / 2,500)^n$$

τ _{k,cr} (psi)	f _{short-term}	K _{sat}	f _c (psi)	n	τ _{k,cr} (psi)
1346	1.00	1.00	2500	0.24	1346

$$N_{ba} = \lambda_a \tau_{cr} \pi d_a h_{ef} \text{ (Eq. 17.4.5.2)}$$

λ _a	τ _{cr} (psi)	d _a (in)	h _{ef} (in)	N _{ba} (lb)
1.00	1346	0.38	4.000	6343

$$\phi N_{ag} = \phi (A_{Na} / A_{Na0}) \psi_{ec,Na} \psi_{ed,Na} \psi_{cp,Na} N_{ba} \text{ (Sec. 17.3.1 \& Eq. 17.4.5.1b)}$$

A _{Na} (in ²)	A _{Na0} (in ²)	c _{Na} (in)	c _{a,min} (in)	ψ _{ec,Na}	ψ _{ed,Na}	ψ _{cp,Na}	N _{ba} (lb)	φ	φN _{ag} (lb)
198.45	112.09	5.29	14.25	1.000	1.000	1.000	6343	0.55	6176



Company:		Date:	5/14/2018
Engineer:		Page:	5/6
Project:			
Address:			
Phone:			
E-mail:			

8. Steel Strength of Anchor in Shear (Sec. 17.5.1)

V_{sa} (lb)	ϕ_{grout}	ϕ	$\phi_{grout}\phi V_{sa}$ (lb)
2715	1.0	0.65	1765

9. Concrete Breakout Strength of Anchor in Shear (Sec. 17.5.2)

Shear perpendicular to edge in x-direction:

$V_{bx} = \min|7(l_e / d_a)^{0.2} \sqrt{d_a \lambda_a} \sqrt{f_c c_{a1}^{1.5}}; 9 \lambda_a \sqrt{f_c c_{a1}^{1.5}}|$ (Eq. 17.5.2.2a & Eq. 17.5.2.2b)

l_e (in)	d_a (in)	λ_a	f_c (psi)	c_{a1} (in)	V_{bx} (lb)
3.00	0.375	1.00	2500	17.75	24294

$\phi V_{cbgx} = \phi (A_{vc} / A_{vco}) \psi_{ec,v} \psi_{ed,v} \psi_{c,v} \psi_{h,v} V_{bx}$ (Sec. 17.3.1 & Eq. 17.5.2.1b)

A_{vc} (in ²)	A_{vco} (in ²)	$\psi_{ec,v}$	$\psi_{ed,v}$	$\psi_{c,v}$	$\psi_{h,v}$	V_{bx} (lb)	ϕ	ϕV_{cbgx} (lb)
1181.48	1417.78	1.000	0.861	1.000	1.000	24294	0.70	12195

Shear perpendicular to edge in y-direction:

$V_{by} = \min|7(l_e / d_a)^{0.2} \sqrt{d_a \lambda_a} \sqrt{f_c c_{a1}^{1.5}}; 9 \lambda_a \sqrt{f_c c_{a1}^{1.5}}|$ (Eq. 17.5.2.2a & Eq. 17.5.2.2b)

l_e (in)	d_a (in)	λ_a	f_c (psi)	c_{a1} (in)	V_{by} (lb)
3.00	0.375	1.00	2500	17.75	24294

$\phi V_{cbgy} = \phi (A_{vc} / A_{vco}) \psi_{ec,v} \psi_{ed,v} \psi_{c,v} \psi_{h,v} V_{by}$ (Sec. 17.3.1 & Eq. 17.5.2.1b)

A_{vc} (in ²)	A_{vco} (in ²)	$\psi_{ec,v}$	$\psi_{ed,v}$	$\psi_{c,v}$	$\psi_{h,v}$	V_{by} (lb)	ϕ	ϕV_{cbgy} (lb)
852.00	1417.78	1.000	0.861	1.000	1.000	24294	0.70	8794

Shear parallel to edge in x-direction:

$V_{by} = \min|7(l_e / d_a)^{0.2} \sqrt{d_a \lambda_a} \sqrt{f_c c_{a1}^{1.5}}; 9 \lambda_a \sqrt{f_c c_{a1}^{1.5}}|$ (Eq. 17.5.2.2a & Eq. 17.5.2.2b)

l_e (in)	d_a (in)	λ_a	f_c (psi)	c_{a1} (in)	V_{by} (lb)
3.00	0.375	1.00	2500	14.25	17475

$\phi V_{cbgx} = \phi (2)(A_{vc} / A_{vco}) \psi_{ec,v} \psi_{ed,v} \psi_{c,v} \psi_{h,v} V_{by}$ (Sec. 17.3.1, 17.5.2.1(c) & Eq. 17.5.2.1b)

A_{vc} (in ²)	A_{vco} (in ²)	$\psi_{ec,v}$	$\psi_{ed,v}$	$\psi_{c,v}$	$\psi_{h,v}$	V_{by} (lb)	ϕ	ϕV_{cbgx} (lb)
684.00	913.78	1.000	1.000	1.000	1.000	17475	0.70	18313

Shear parallel to edge in y-direction:

$V_{bx} = \min|7(l_e / d_a)^{0.2} \sqrt{d_a \lambda_a} \sqrt{f_c c_{a1}^{1.5}}; 9 \lambda_a \sqrt{f_c c_{a1}^{1.5}}|$ (Eq. 17.5.2.2a & Eq. 17.5.2.2b)

l_e (in)	d_a (in)	λ_a	f_c (psi)	c_{a1} (in)	V_{bx} (lb)
3.00	0.375	1.00	2500	14.25	17475

$\phi V_{cbgy} = \phi (2)(A_{vc} / A_{vco}) \psi_{ec,v} \psi_{ed,v} \psi_{c,v} \psi_{h,v} V_{bx}$ (Sec. 17.3.1, 17.5.2.1(c) & Eq. 17.5.2.1b)

A_{vc} (in ²)	A_{vco} (in ²)	$\psi_{ec,v}$	$\psi_{ed,v}$	$\psi_{c,v}$	$\psi_{h,v}$	V_{bx} (lb)	ϕ	ϕV_{cbgy} (lb)
836.30	913.78	1.000	1.000	1.000	1.000	17475	0.70	22391

10. Concrete Pryout Strength of Anchor in Shear (Sec. 17.5.3)

$\phi V_{cp} = \phi \min|k_{cp} N_{ag}; k_{cp} N_{cbg}| = \phi \min|k_{cp} (A_{Na} / A_{Na0}) \psi_{ec,Na} \psi_{ed,Na} \psi_{cp,Na} N_{ba}; k_{cp} (A_{Nc} / A_{Nco}) \psi_{ec,N} \psi_{ed,N} \psi_{c,N} \psi_{cp,N} N_b|$ (Sec. 17.3.1 & Eq. 17.5.3.1b)

k_{cp}	A_{Na} (in ²)	A_{Na0} (in ²)	$\psi_{ed,Na}$	$\psi_{ec,Na}$	$\psi_{cp,Na}$	N_{ba} (lb)	N_a (lb)
2.0	198.45	112.09	1.000	1.000	1.000	6343	11230

A_{Nc} (in ²)	A_{Nco} (in ²)	$\psi_{ec,N}$	$\psi_{ed,N}$	$\psi_{c,N}$	$\psi_{cp,N}$	N_b (lb)	N_{cb} (lb)	ϕ
240.25	144.00	1.000	1.000	1.000	1.000	6800	11345	0.70

Input data and results must be checked for agreement with the existing circumstances, the standards and guidelines must be checked for plausibility.



Company:		Date:	5/14/2018
Engineer:		Page:	6/6
Project:			
Address:			
Phone:			
E-mail:			

ϕV_{cpq} (lb)
15722

11. Results

Interaction of Tensile and Shear Forces (Sec. R17.6)

Tension	Factored Load, N_{ua} (lb)	Design Strength, ϕN_n (lb)	Ratio	Status
Steel	964	3394	0.28	Pass
Concrete breakout	3855	7374	0.52	Pass
Adhesive	3855	6176	0.62	Pass (Governs)

Shear	Factored Load, V_{ua} (lb)	Design Strength, ϕV_n (lb)	Ratio	Status
Steel	677	1765	0.38	Pass (Governs)
T Concrete breakout x+	250	12195	0.02	Pass
T Concrete breakout y-	2695	8794	0.31	Pass
Concrete breakout y-	125	18313	0.01	Pass
Concrete breakout x-	1348	22391	0.06	Pass
Concrete breakout, combined	-	-	0.31	Pass
Pryout	2707	15722	0.17	Pass

Interaction check	$(N_{ua}/\phi N_{ua})^{5/3}$	$(V_{ua}/\phi V_{ua})^{5/3}$	Combined Ratio	Permissible	Status
Sec. R17.6	0.46	0.20	65.8%	1.0	Pass

SET-3G w/ 3/8"Ø F1554 Gr. 36 with hef = 4.000 inch meets the selected design criteria.

12. Warnings

- Designer must exercise own judgement to determine if this design is suitable.
- Refer to manufacturer's product literature for hole cleaning and installation instructions.

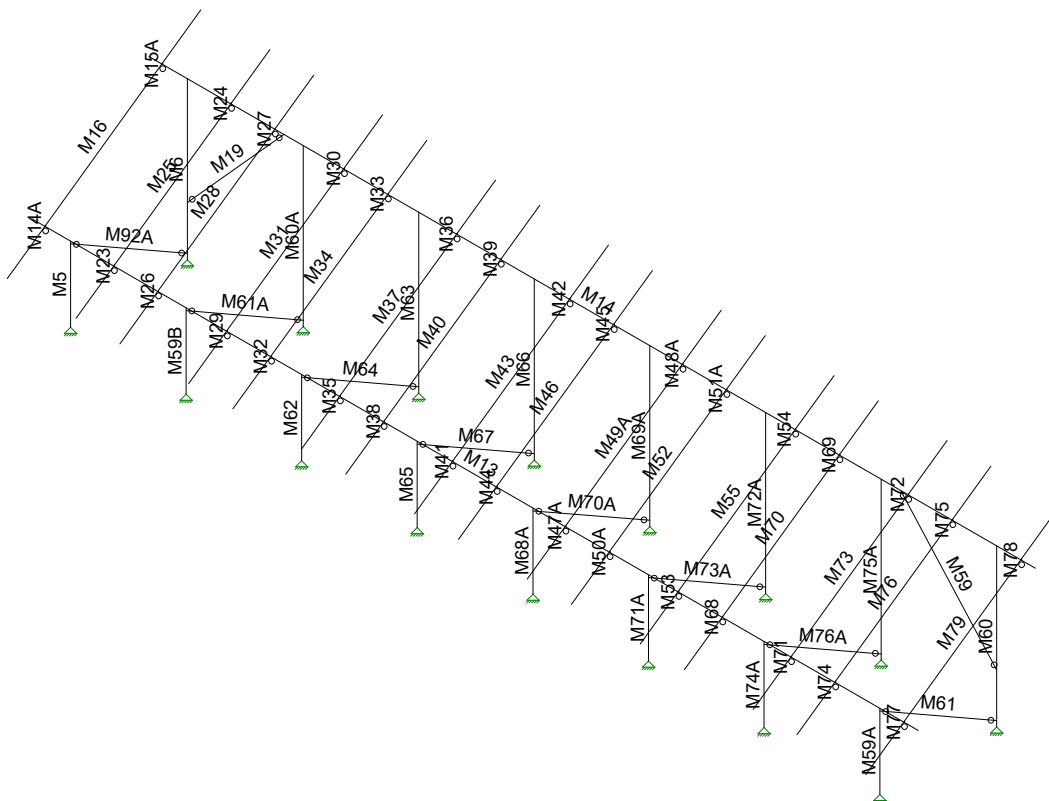

Vector Structural Engineeri...

STB

U2716-0218-201

Ground Mount

SK - 3

June 25, 2020 at 2:55 PM

Sunmodo Sunturf A8.r3d

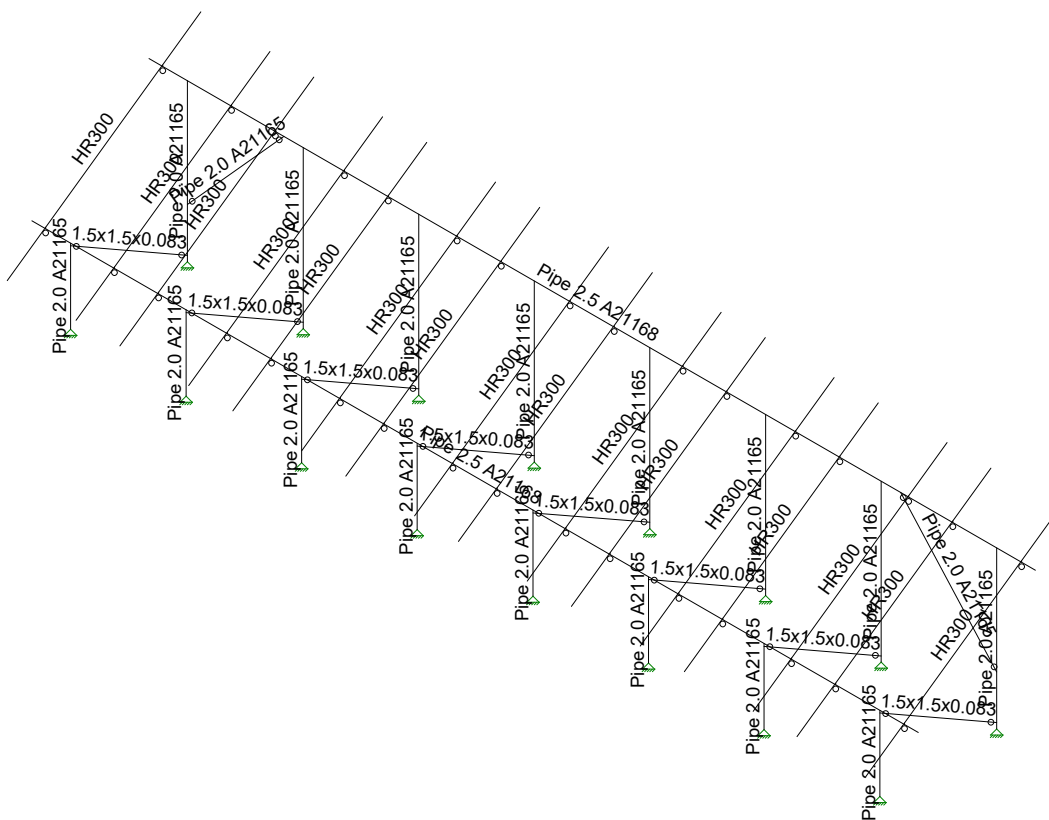

Vector Structural Engineeri...

STB

U2716-0218-201

Ground Mount

SK - 4

June 25, 2020 at 2:56 PM

Sunmodo Sunturf A8.r3d

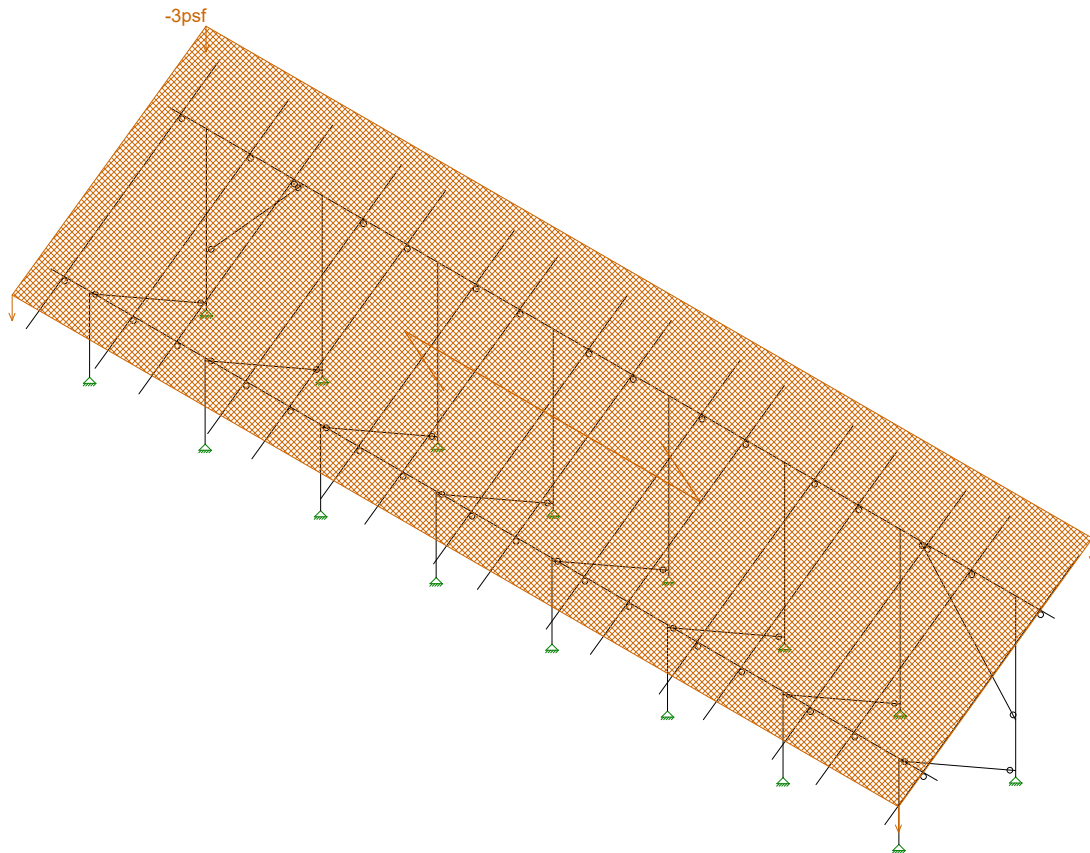

Loads: BLC 2, Solar Panel Weight

Vector Structural Engineeri...

STB

U2716-0218-201

Ground Mount

SK - 5

June 25, 2020 at 2:56 PM

Sunmodo Sunturf A8.r3d

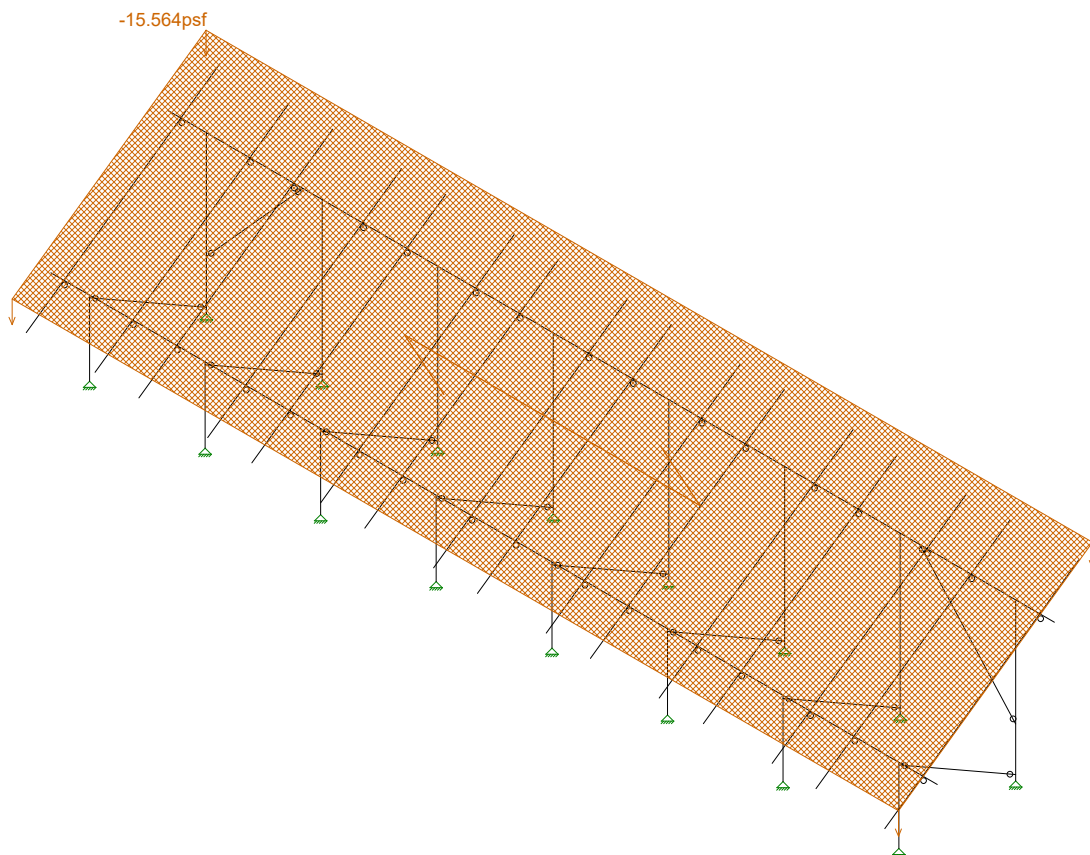

Loads: BLC 3, Roof Live/Snow

Vector Structural Engineeri...

STB

U2716-0218-201

Ground Mount

SK - 6

June 25, 2020 at 2:56 PM

Sunmodo Sunturf A8.r3d

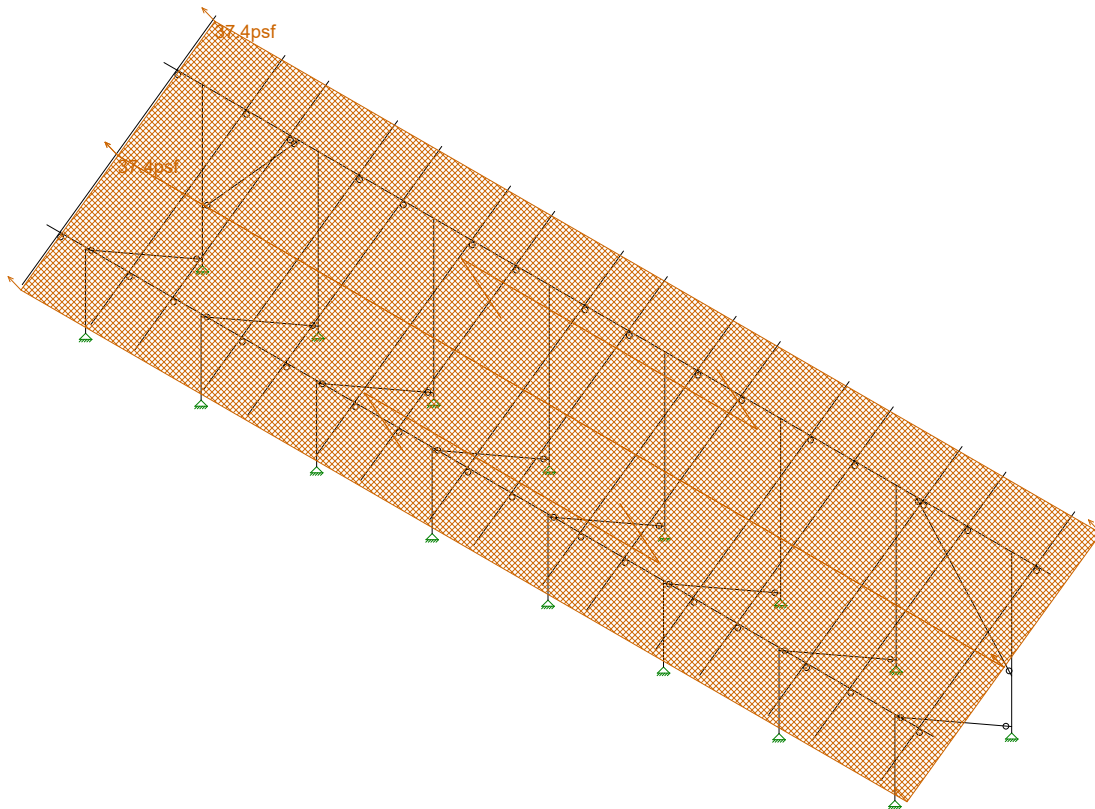

Loads: BLC 4, Wind 1

Vector Structural Engineeri..	Ground Mount	SK - 7
STB		June 25, 2020 at 2:56 PM
U2716-0218-201		Sunmodo Sunturf A8.r3d

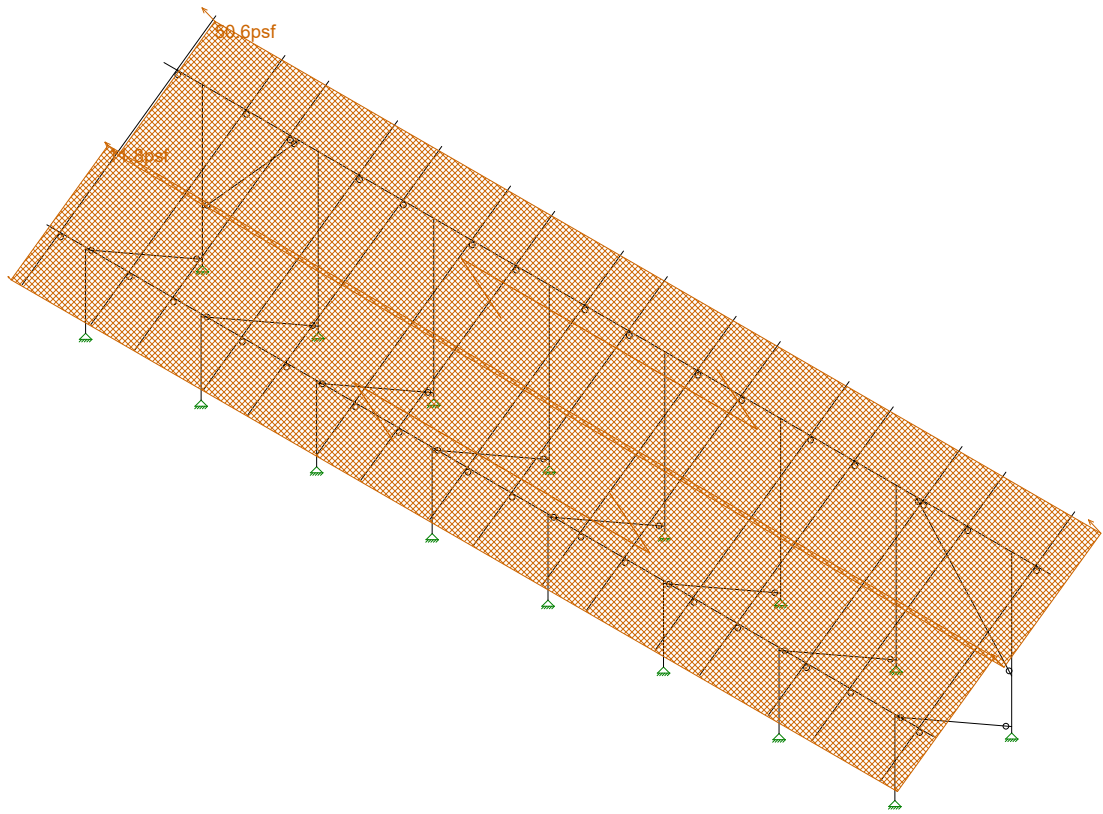

Loads: BLC 5, Wind 2

Vector Structural Engineeri...
STB
U2716-0218-201

Ground Mount

SK - 8

June 25, 2020 at 2:56 PM

Sunmodo Sunturf A8.r3d

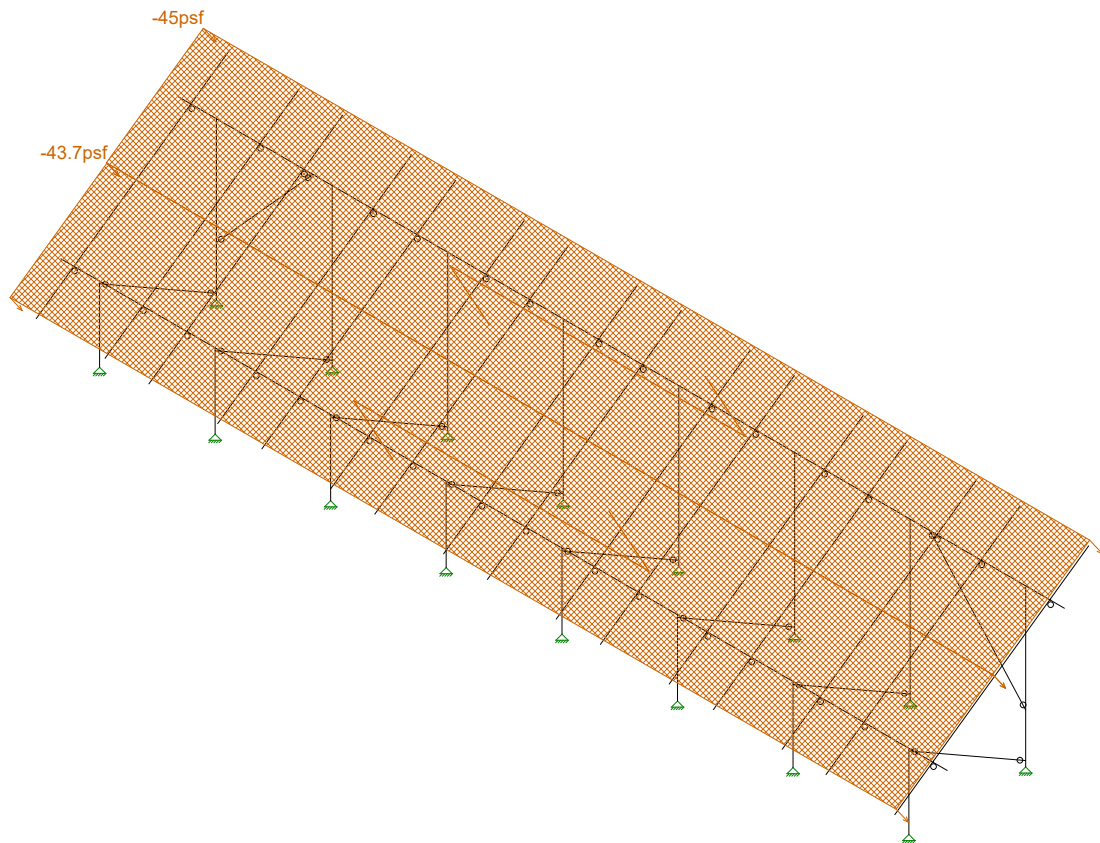

Loads: BLC 6, Wind 3

Vector Structural Engineeri...
STB
U2716-0218-201

Ground Mount

SK - 9

June 25, 2020 at 2:56 PM

Sunmodo Sunturf A8.r3d

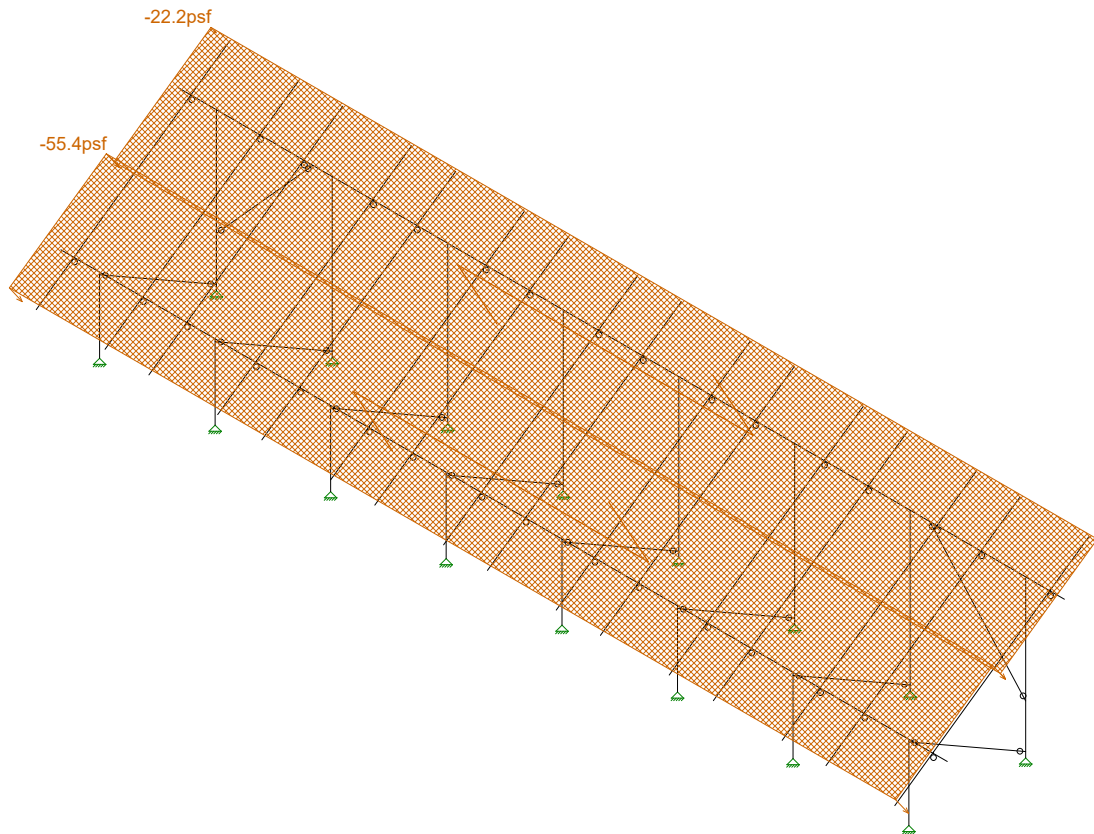

Loads: BLC 7, Wind 4

Vector Structural Engineeri...

STB

U2716-0218-201

Ground Mount

SK - 10

June 25, 2020 at 2:56 PM

Sunmodo Sunturf A8.r3d



Code Check
(%)

Black	No Calc
Red	> 1.0
Yellow	40-1.0
Green	75-90
Blue	50-75
Light Blue	0-.50

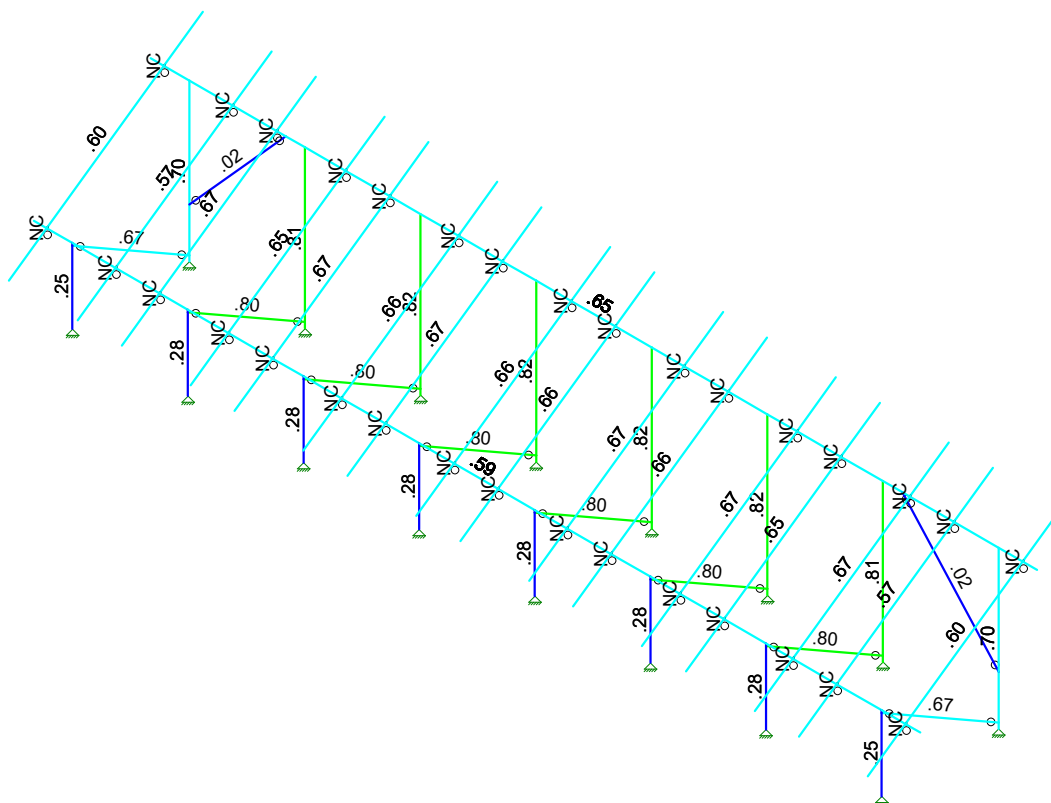

Member Code Checks Displayed (Enveloped)
Envelope Only Solution

Vector Structural Engineeri...	Ground Mount	SK - 1
STB		June 25, 2020 at 2:55 PM
U2716-0218-201		Sunmodo Sunturf A8.r3d



Shear Check
(Enr)
No Calc
> 1.0
40-1.0
75-90
50-75
0-.50

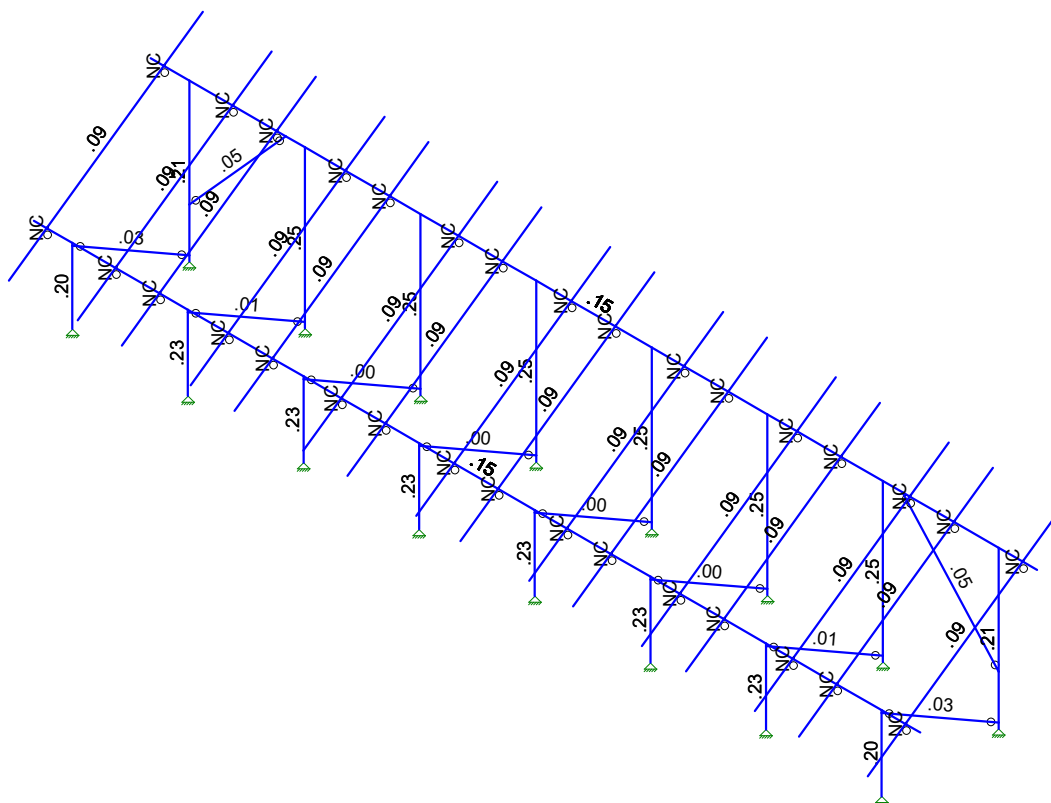

Member Shear Checks Displayed (Enveloped)
Envelope Only Solution

Vector Structural Engineeri...	Ground Mount	SK - 2
STB		June 25, 2020 at 2:55 PM
U2716-0218-201		Sunmodo Sunturf A8.r3d



(Global) Model Settings

Display Sections for Member Calcs	5
Max Internal Sections for Member Calcs	97
Include Shear Deformation?	Yes
Increase Nailing Capacity for Wind?	Yes
Include Warping?	Yes
Trans Load Btwn Intersecting Wood Wall?	Yes
Area Load Mesh (in^2)	144
Merge Tolerance (in)	.12
P-Delta Analysis Tolerance	0.50%
Include P-Delta for Walls?	Yes
Automatically Iterate Stiffness for Walls?	Yes
Max Iterations for Wall Stiffness	3
Gravity Acceleration (in/sec^2)	386.4
Wall Mesh Size (in)	24
Eigensolution Convergence Tol. (1.E-)	4
Vertical Axis	Y
Global Member Orientation Plane	XZ
Static Solver	Sparse Accelerated
Dynamic Solver	Accelerated Solver

Hot Rolled Steel Code	AISC 14th(360-10): ASD
Adjust Stiffness?	Yes(Iterative)
RISACONNECTION CODE	AISC 14th(360-10): ASD
Cold Formed Steel Code	AISI S100-12: ASD
Wood Code	AWC NDS-15: ASD
Wood Temperature	< 100F
Concrete Code	ACI 318-14
Masonry Code	ACI 530-13: ASD
Aluminum Code	AA ADM1-15: ASD - Building
Stainless Steel Code	AISC 14th(360-10): ASD
Adjust Stiffness?	Yes(Iterative)

Number of Shear Regions	4
Region Spacing Increment (in)	4
Biaxial Column Method	Exact Integration
Parame Beta Factor (PCA)	.65
Concrete Stress Block	Rectangular
Use Cracked Sections?	Yes
Use Cracked Sections Slab?	No
Bad Framing Warnings?	No
Unused Force Warnings?	Yes
Min 1 Bar Diam. Spacing?	No
Concrete Rebar Set	REBAR SET ASTMA615
Min % Steel for Column	1
Max % Steel for Column	8



(Global) Model Settings, Continued

Seismic Code	ASCE 7-10
Seismic Base Elevation (in)	15600
Add Base Weight?	Yes
Ct X	.02
Ct Z	.02
T X (sec)	Not Entered
T Z (sec)	Not Entered
R X	3
R Z	3
Ct Exp. X	.75
Ct Exp. Z	.75
SD1	1
SDS	1
S1	1
TL (sec)	5
Risk Cat	I or II
Drift Cat	Other
Om Z	1
Om X	1
Cd Z	4
Cd X	4
Rho Z	1
Rho X	1

Hot Rolled Steel Properties

	Label	E [ksi]	G [ksi]	Nu	Therm (/1E5 F)	Density[lb/ft^3]	Yield[psi]	Ry	Fu[psi]	Rt
1	A992	29000	11154	.3	.65	490	50000	1.1	65000	1.1
2	A36 Gr.36	29000	11154	.3	.65	490	36000	1.5	58000	1.2
3	A572 Gr.50	29000	11154	.3	.65	490	50000	1.1	65000	1.1
4	A500 Gr.B R...	29000	11154	.3	.65	527	42000	1.4	58000	1.3
5	A500 Gr.B Re...	29000	11154	.3	.65	527	46000	1.4	58000	1.3
6	A53 Gr.B	29000	11154	.3	.65	490	35000	1.6	60000	1.2
7	A1085	29000	11154	.3	.65	490	50000	1.4	65000	1.3

Aluminum Properties

	Label	E [ksi]	G [ksi]	Nu	Therm (...Density[... Table B.4	kt	Ftu[psi]	Fty[psi]	Fcy[psi]	Fsu[psi]	Ct
1	3003-H14	10100	3787.5	.33	1.3 172.8 Table B.4-1	1	19000	16000	13000	12000	141
2	6061-T6	10100	3787.5	.33	1.3 172.8 Table B.4-2	1	38000	35000	35000	24000	141
3	6063-T5	10100	3787.5	.33	1.3 172.8 Table B.4-2	1	22000	16000	16000	13000	141
4	6063-T6	10100	3787.5	.33	1.3 172.8 Table B.4-2	1	30000	25000	25000	19000	141
5	5052-H34	10200	3787.5	.33	1.3 172.8 Table B.4-1	1	34000	26000	24000	20000	141
6	6061-T6 W	10100	3787.5	.33	1.3 172.8 Table B.4-1	1	24000	15000	15000	15000	141
7	6005-T5	10100	3787.5	.33	1.3 172.8 Table B.4-1	1	38000	35000	35000	24000	141

Hot Rolled Steel Section Sets

	Label	Shape	Type	Design List	Material	Design R...	A [in2]	Iyy [in4]	Izz [in4]	J [in4]
1	Post	Pipe 2.0 A21165	Column	Pipe	A572 Gr.50	Typical	.776	.499	.499	.998
2	Cross Beam	Pipe 2.5 A21168	Beam	Wide Flange	A572 Gr.50	Typical	.947	.907	.907	1.814
3	Diagonal Brace	1.5x1.5x0.083	HBrace	SquareTube	A572 Gr.50	Typical	.47	.158	.158	.236



Company : Vector Structural Engineering
 Designer : STB
 Job Number : U2716-0218-201
 Model Name : Ground Mount

June 25, 2020
 2:57 PM
 Checked By: _____

Aluminum Section Sets

	Label	Shape	Type	Design List	Material	Design R...	A [in2]	Iyy [in4]	Izz [in4]	J [in4]
1	AL Posts	2.375ODX0.188	Column	Pipe	6005-T5	Typical	1.29	.778	.778	1.54
2	AL Brace	RT1.5x2x0.15625	VBrace	Rectangular Tubes	6005-T5	Typical	.996	.327	.524	.602
3	AL Rails	HR300	Beam	Rectangular Tubes	6005-T5	Typical	.74	.253	.727	.578
4	AL Cross Beam	Cross Rail	Beam	Rectangular Tubes	6005-T5	Typical	1.909	1.97	4.366	4.017

Member Area Loads (BLC 2 : Solar Panel Weight)

	Joint A	Joint B	Joint C	Joint D	Direction	Distribution	Magnitude[psf]
1	N197	N200	N199	N196	Y	A-B	-3

Member Area Loads (BLC 3 : Roof Live/Snow)

	Joint A	Joint B	Joint C	Joint D	Direction	Distribution	Magnitude[psf]
1	N197	N200	N199	N196	PY	A-B	-19

Member Area Loads (BLC 4 : Wind 1)

	Joint A	Joint B	Joint C	Joint D	Direction	Distribution	Magnitude[psf]
1	N197	N119B	N120B	N200	Perp	B-C	37.4
2	N119B	N196	N199	N120B	Perp	B-C	37.4

Member Area Loads (BLC 5 : Wind 2)

	Joint A	Joint B	Joint C	Joint D	Direction	Distribution	Magnitude[psf]
1	N197	N119B	N120B	N200	Perp	B-C	50.6
2	N119B	N196	N199	N120B	Perp	B-C	11.8

Member Area Loads (BLC 6 : Wind 3)

	Joint A	Joint B	Joint C	Joint D	Direction	Distribution	Magnitude[psf]
1	N197	N119B	N120B	N200	Perp	B-C	-45
2	N119B	N196	N199	N120B	Perp	B-C	-43.7

Member Area Loads (BLC 7 : Wind 4)

	Joint A	Joint B	Joint C	Joint D	Direction	Distribution	Magnitude[psf]
1	N197	N119B	N120B	N200	Perp	B-C	-22.2
2	N119B	N196	N199	N120B	Perp	B-C	-55.4

Basic Load Cases

	BLC Description	Category	X Gravity	Y Gravity	Z Gravity	Joint	Point	Distributed	Area(M...Surface...
1	Self Weight	DL		-1.05					
2	Solar Panel Weight	DL							1
3	Roof Live/Snow	RLL							1
4	Wind 1	OL1							2
5	Wind 2	OL2							2
6	Wind 3	OL3							2
7	Wind 4	OL4							2
8	BLC 2 Transient Area ...	None						40	
9	BLC 3 Transient Area ...	None						40	
10	BLC 4 Transient Area ...	None						192	
11	BLC 5 Transient Area ...	None						192	
12	BLC 6 Transient Area ...	None						192	
13	BLC 7 Transient Area ...	None						192	



Company : Vector Structural Engineering
 Designer : STB
 Job Number : U2716-0218-201
 Model Name : Ground Mount

June 25, 2020
 2:57 PM
 Checked By: _____

Load Combinations

	Description	S...	PD...	SRSS	BLC	Fa...	BLC	Fa...	BLC	Fa...	B...	Fa...	B...	Fa...	B...	Fa...	B...	Fa...	B...	Fa...	B...	Fa...	B...	
1	ASD Loads		Y																					
2	1.0 D	Yes	Y		DL	1																		
3	1.0 D + 1.0 S	Yes	Y		DL	1	RLL	1																
4	1.0 D + 0.6 W1	Yes	Y		DL	1	RLL		OL1	.6														
5	1.0 D + 0.6 W2	Yes	Y		DL	1	RLL		OL2	.6														
6	1.0 D + 0.6 W3	Yes	Y		DL	1	RLL		OL3	.6														
7	1.0 D + 0.6 W4	Yes	Y		DL	1	RLL		OL4	.6														
8	1.0 D + 0.45 W1 + 0....	Yes	Y		DL	1	RLL	.75	OL1	.45														
9	1.0 D + 0.45 W2 + 0....	Yes	Y		DL	1	RLL	.75	OL2	.45														
10	1.0 D + 0.45 W3 + 0....	Yes	Y		DL	1	RLL	.75	OL3	.45														
11	1.0 D + 0.45 W4 + 0....	Yes	Y		DL	1	RLL	.75	OL4	.45														
12	0.6 D + 0.6 W1	Yes	Y		DL	.6	RLL		OL1	.6														
13	0.6 D + 0.6 W2	Yes	Y		DL	.6	RLL		OL2	.6														
14	0.6 D + 0.6 W3	Yes	Y		DL	.6	RLL		OL3	.6														
15	0.6 D + 0.6 W4	Yes	Y		DL	.6	RLL		OL4	.6														
16			Y																					
17	LRFD Loads		Y																					
18	1.4 D		Y		DL	1.4	RLL																	
19	1.2 D + 1.6 S + 0.5 W1		Y		DL	1.2	RLL	1.6	OL1	.5														
20	1.2 D + 1.6 S + 0.5 W2		Y		DL	1.2	RLL	1.6	OL2	.5														
21	1.2 D + 1.6 S + 0.5 W3		Y		DL	1.2	RLL	1.6	OL3	.5														
22	1.2 D + 1.6 S + 0.5 W4		Y		DL	1.2	RLL	1.6	OL4	.5														
23	1.2 D + 1.0 W1		Y		DL	1.2	RLL		OL1	1														
24	1.2 D + 1.0 W2		Y		DL	1.2	RLL		OL2	1														
25	1.2 D + 1.0 W3		Y		DL	1.2	RLL		OL3	1														
26	1.2 D + 1.0 W4		Y		DL	1.2	RLL		OL4	1														
27	0.9 D + 1.0 W1		Y		DL	.9	RLL		OL1	1														
28	0.9 D + 1.0 W2		Y		DL	.9	RLL		OL2	1														
29	0.9 D + 1.0 W3		Y		DL	.9	RLL		OL3	1														
30	0.9 D + 1.0 W4		Y		DL	.9	RLL		OL4	1														

Envelope Joint Reactions

	Joint	X [lb]	LC	Y [lb]	LC	Z [lb]	LC	MX [lb-ft]	LC	MY [lb-...	LC	MZ [lb-ft]	LC
1	N2	max 1.279	6	1215.218	9	63.038	4	0	15	0	15	0	15
2		min -3.41	13	-270.13	14	-73.608	6	0	2	0	2	0	2
3	N1	max 39.083	10	2473.95	6	1358.47	6	0	15	0	15	0	15
4		min -43.366	13	-1968.696	13	-1147....	12	0	2	0	2	0	2
5	N123	max 43.672	13	2473.253	6	1358.7...	6	0	15	0	15	0	15
6		min -39.68	10	-1969.611	13	-1147....	12	0	2	0	2	0	2
7	N124	max 4.869	9	1218.153	9	63.044	4	0	15	0	15	0	15
8		min -.802	14	-269.404	14	-73.618	6	0	2	0	2	0	2
9	N123A	max 1.556	13	2814.945	6	1607.1...	6	0	15	0	15	0	15
10		min -2.202	6	-2216.999	13	-1353....	4	0	2	0	2	0	2
11	N124A	max 3.08	14	1479.901	9	68.923	4	0	15	0	15	0	15
12		min -7.811	9	-348.511	14	-80.873	6	0	2	0	2	0	2
13	N129	max 1.541	13	2871.368	6	1609.9...	6	0	15	0	15	0	15
14		min -1.649	10	-2301.894	13	-1361....	4	0	2	0	2	0	2
15	N130	max .226	14	1466.489	9	70.809	4	0	15	0	15	0	15
16		min -3.656	9	-332.463	14	-82.825	6	0	2	0	2	0	2
17	N135	max .406	13	2874.394	6	1615.1...	6	0	15	0	15	0	15
18		min -.516	6	-2298.476	13	-1362....	4	0	2	0	2	0	2
19	N136	max .355	14	1470.904	9	71.311	4	0	15	0	15	0	15
20		min -1.526	9	-341.095	14	-83.334	6	0	2	0	2	0	2
21	N141	max .549	10	2874.477	6	1615.1...	6	0	15	0	15	0	15



Company : Vector Structural Engineering
 Designer : STB
 Job Number : U2716-0218-201
 Model Name : Ground Mount

June 25, 2020
 2:57 PM
 Checked By: _____

Envelope Joint Reactions (Continued)

Joint	X [lb]	LC	Y [lb]	LC	Z [lb]	LC	MX [lb-ft]	LC	MY [lb-ft]	LC	MZ [lb-ft]	LC	
22	min	- .493	13	-2298.429	13	-1362....	4	0	2	0	2	0	2
23	N142	max	1.14	9	1470.703	9	71.312	4	0	15	0	15	0
24		min	-.326	14	-341.152	14	-83.335	6	0	2	0	2	0
25	N147B	max	1.645	10	2871.29	6	1610.1...	6	0	15	0	15	0
26		min	-1.643	13	-2302.428	13	-1361....	4	0	2	0	2	0
27	N148A	max	3.473	9	1468.014	9	70.81	4	0	15	0	15	0
28		min	-.167	14	-332.381	14	-82.827	6	0	2	0	2	0
29	N153A	max	2.35	10	2816.316	6	1606.84	6	0	15	0	15	0
30		min	-1.578	13	-2214.523	13	-1353....	4	0	2	0	2	0
31	N154A	max	6.49	5	1469.517	9	68.915	4	0	15	0	15	0
32		min	-3.168	14	-349.498	14	-80.862	6	0	2	0	2	0
33	Totals:	max	0	10	24908.307	10	11740....	14					
34		min	0	13	-12127.493	12	-9900....	12					

Envelope AISC 14th(360-10): ASD Steel Code Checks

Member	Shape	Code Check	Loc[in]	LC	Shear	...	Loc[in]	Dir	LC	Pnc/om	...	Pnt/om [lb]	Mny/om	Mnz/om	Cb	Eqn
1	M5	Pipe 2.0 A2...	.250	52.516	6	.198	52.516		6	16635.531	23232.186	1397.505	1397.505	2...	H1-1b	
2	M6	Pipe 2.0 A2...	.702	3.56	6	.209	0		6	5780.675	23232.186	1397.505	1397.505	1...	H1-1a	
3	M13	Pipe 2.5 A2...	.585	449....	11	.154	107....		6	14032.946	28358.413	2081.747	2081.747	1	H1-1b	
4	M14	Pipe 2.5 A2...	.648	194....	10	.149	550....		10	14032.946	28358.413	2081.747	2081.747	1	H1-1b	
5	M19	Pipe 2.0 A2...	.021	53.532	10	.050	0		6	6821.523	23232.186	1397.505	1397.505	1...	H1-1b	
6	M92A	1.5x1.5x0.083	.674	50.973	6	.027	0	y	6	2479.016	14085.15	624.421	624.421	1...	H1-1a	
7	M59	Pipe 2.0 A2...	.021	53.446	10	.050	0		6	6843.259	23232.186	1397.505	1397.505	1...	H1-1b	
8	M59A	Pipe 2.0 A2...	.250	52.516	6	.198	52.516		6	16635.531	23232.186	1397.505	1397.505	3...	H1-1b	
9	M60	Pipe 2.0 A2...	.702	3.56	6	.209	0		6	5780.675	23232.186	1397.505	1397.505	1...	H1-1a	
10	M61	1.5x1.5x0.083	.674	50.973	6	.027	0	y	6	2479.016	14085.15	624.421	624.421	1...	H1-1a	
11	M59B	Pipe 2.0 A2...	.276	52.516	6	.231	52.516		6	16635.531	23232.186	1397.505	1397.505	1...	H1-1b	
12	M60A	Pipe 2.0 A2...	.811	3.56	6	.247	0		6	5780.675	23232.186	1397.505	1397.505	1...	H1-1a	
13	M61A	1.5x1.5x0.083	.796	50.973	6	.006	97.868	y	5	2479.016	14085.15	624.421	624.421	1...	H1-1a	
14	M62	Pipe 2.0 A2...	.282	52.516	6	.231	52.516		6	16635.531	23232.186	1397.505	1397.505	2...	H1-1b	
15	M63	Pipe 2.0 A2...	.822	3.56	6	.248	0		6	5780.675	23232.186	1397.505	1397.505	1...	H1-1a	
16	M64	1.5x1.5x0.083	.797	50.973	6	.004	97.868	y	9	2479.016	14085.15	624.421	624.421	1...	H1-1a	
17	M65	Pipe 2.0 A2...	.284	52.516	6	.231	52.516		6	16635.531	23232.186	1397.505	1397.505	1...	H1-1b	
18	M66	Pipe 2.0 A2...	.824	3.56	6	.249	0		6	5780.675	23232.186	1397.505	1397.505	1...	H1-1a	
19	M67	1.5x1.5x0.083	.800	50.973	6	.002	0	y	9	2479.016	14085.15	624.421	624.421	1...	H1-1a	
20	M68A	Pipe 2.0 A2...	.284	52.516	6	.231	52.516		6	16635.531	23232.186	1397.505	1397.505	1...	H1-1b	
21	M69A	Pipe 2.0 A2...	.824	3.56	6	.249	0		6	5780.675	23232.186	1397.505	1397.505	1...	H1-1a	
22	M70A	1.5x1.5x0.083	.800	50.973	6	.002	97.868	y	9	2479.016	14085.15	624.421	624.421	1...	H1-1a	
23	M71A	Pipe 2.0 A2...	.282	52.516	6	.231	52.516		6	16635.531	23232.186	1397.505	1397.505	3...	H1-1b	
24	M72A	Pipe 2.0 A2...	.822	3.56	6	.248	0		6	5780.675	23232.186	1397.505	1397.505	1...	H1-1a	
25	M73A	1.5x1.5x0.083	.797	50.973	6	.004	97.868	y	9	2479.016	14085.15	624.421	624.421	1...	H1-1a	
26	M74A	Pipe 2.0 A2...	.276	52.516	6	.231	52.516		6	16635.531	23232.186	1397.505	1397.505	1...	H1-1b	
27	M75A	Pipe 2.0 A2...	.811	3.56	6	.247	0		6	5780.675	23232.186	1397.505	1397.505	1...	H1-1a	
28	M76A	1.5x1.5x0.083	.796	50.973	6	.006	97.868	y	5	2479.016	14085.15	624.421	624.421	1...	H1-1a	

Envelope AA ADM1-15: ASD - Building Aluminum Code Checks

Member	Shape	Code C...	Loc[in]	LC	Shear	...	Loc[in]	Dir	LC	Pnc/O...	Pnt/Om...	Mny/O...	Mnz/O...	Vny/O...	Vnz/O...	Cb	Eqn
1	M16	HR300	.605	87.792	10	.088	35.833	y	11	3465.417	14429....	560.361	934.132	5656.689	2605.145	1...	H-1-1
2	M25	HR300	.571	87.792	10	.088	35.833	y	11	3465.417	14429....	560.361	934.132	5656.689	2605.145	1...	H-1-1
3	M28	HR300	.673	87.792	10	.095	35.833	y	11	3465.417	14429....	560.361	934.132	5656.689	2605.145	1...	H-1-1
4	M31	HR300	.654	87.792	10	.093	35.833	y	11	3465.417	14429....	560.361	934.132	5656.689	2605.145	1...	H-1-1
5	M34	HR300	.670	87.792	10	.095	35.833	y	11	3465.417	14429....	560.361	934.132	5656.689	2605.145	1...	H-1-1
6	M37	HR300	.659	87.792	10	.094	35.833	y	11	3465.417	14429....	560.361	934.132	5656.689	2605.145	1...	H-1-1
7	M40	HR300	.667	87.792	10	.095	35.833	y	11	3465.417	14429....	560.361	934.132	5656.689	2605.145	1...	H-1-1



Envelope AA ADM1-15: ASD - Building Aluminum Code Checks (Continued)

Member	Shape	Code C...	Loc[fin]	LC Shear ...	Loc[fin]	Dir	LC Pnc/O...	Pnt/Om...	Mny/O...	Mnz/O...	Vny/O...	Vnz/O...	Cb	Eqn			
8	M43	HR300	.663	87.792	10	.094	35.833	y	11	3465.417	14429....	560.361	934.132	5656.689	2605.145	1...	H.1-1
9	M46	HR300	.663	87.792	10	.094	35.833	y	11	3465.417	14429....	560.361	934.132	5656.689	2605.145	1...	H.1-1
10	M49A	HR300	.667	87.792	10	.094	35.833	y	11	3465.417	14429....	560.361	934.132	5656.689	2605.145	1...	H.1-1
11	M52	HR300	.658	87.792	10	.094	35.833	y	11	3465.417	14429....	560.361	934.132	5656.689	2605.145	1...	H.1-1
12	M55	HR300	.670	87.792	10	.095	35.833	y	11	3465.417	14429....	560.361	934.132	5656.689	2605.145	1...	H.1-1
13	M70	HR300	.654	87.792	10	.093	35.833	y	11	3465.417	14429....	560.361	934.132	5656.689	2605.145	1...	H.1-1
14	M73	HR300	.674	87.792	10	.094	35.833	y	11	3465.417	14429....	560.361	934.132	5656.689	2605.145	1...	H.1-1
15	M76	HR300	.570	87.792	10	.086	35.833	y	11	3465.417	14429....	560.361	934.132	5656.689	2605.145	1...	H.1-1
16	M79	HR300	.605	87.792	10	.091	35.833	y	11	3465.417	14429....	560.361	934.132	5656.689	2605.145	1...	H.1-1