

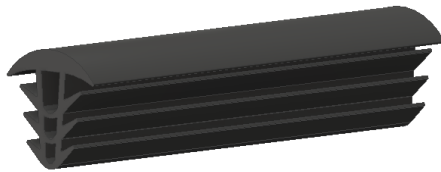

# **Solar Panel Seam Gasket Installation Manual**

# Solar Panel Seam Gasket Installation Tips

1. THESE INSTALLATION INSTRUCTIONS ARE OF A GENERAL NATURE AND COVER THE MOST COMMON CONDITIONS AND SITUATIONS.
2. Sealants must be compatible with the EPDM material of the gasket. Consult with the sealant manufacturer for recommendations regarding compatibility and adhesion.
3. This EPDM gasket has been designed to provide water leak protection, not water proofing. It is supplied in a 26-ft (8m) long roll; enough material to cover the long edge gaps between approximately 5 solar panels.
4. Clean aluminum surfaces with a mild detergent and water before installing the gasket. No abrasive agent shall be used.
5. Not intended for sealing interior living spaces as defined under the IBC 2012-15 code.



Install the Press-in Seam Gasket in the gaps between the solar panels. The Press-in Seam Gasket has been designed to fit 1/2 inch gaps with a tolerance of plus or minus 1/4 inch.



# Solar Panel Seam Gasket Installation Tips

## Tools Recommended:

- ✓ Tape Measure
- ✓ Benchmark (style) Cutting Knives
- ✓ Ratchet Action Pipe Cutter
- ✓ Black or Clear EPDM compatible Sealant
- ✓ Mild Soap, Water and Sponge
- ✓ Dead Blow Hammer



# Solar Panel Seam Gasket Installation Tips

Eliminate the gaps and protect the space below your outdoor living space from sunlight and rain by installing weather stripping between your PV Modules. If you are installing our solar canopy, solar carport or solar awning systems this product prevents water from dripping between the solar panels.

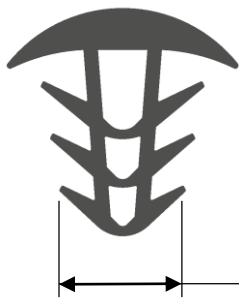

Press-in Seam Gasket (C10042-315) accommodates gaps between panels ranging from .25 to .75 inches

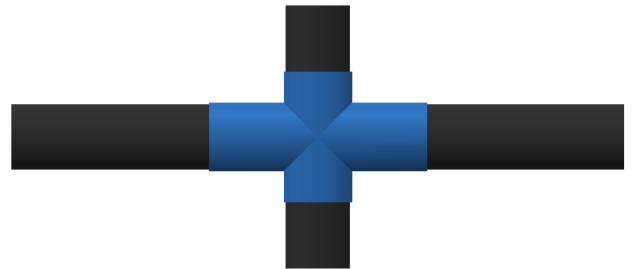

**Tip:** To seal gaps between panels up to 1" use Press-in Seam Gasket C10040-315



Glue-on Intersection Cap (C10041-002)

**Tip:** Use a copious amount of Sealant on the bottom side of the Glue-on Intersection Gasket.

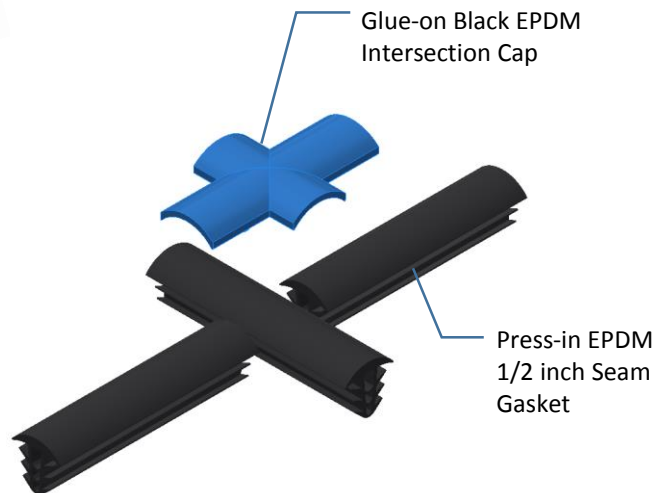

Glue-on Black EPDM Intersection Cap

Press-in EPDM 1/2 inch Seam Gasket

# Solar Panel Seam Gasket Installation Tips

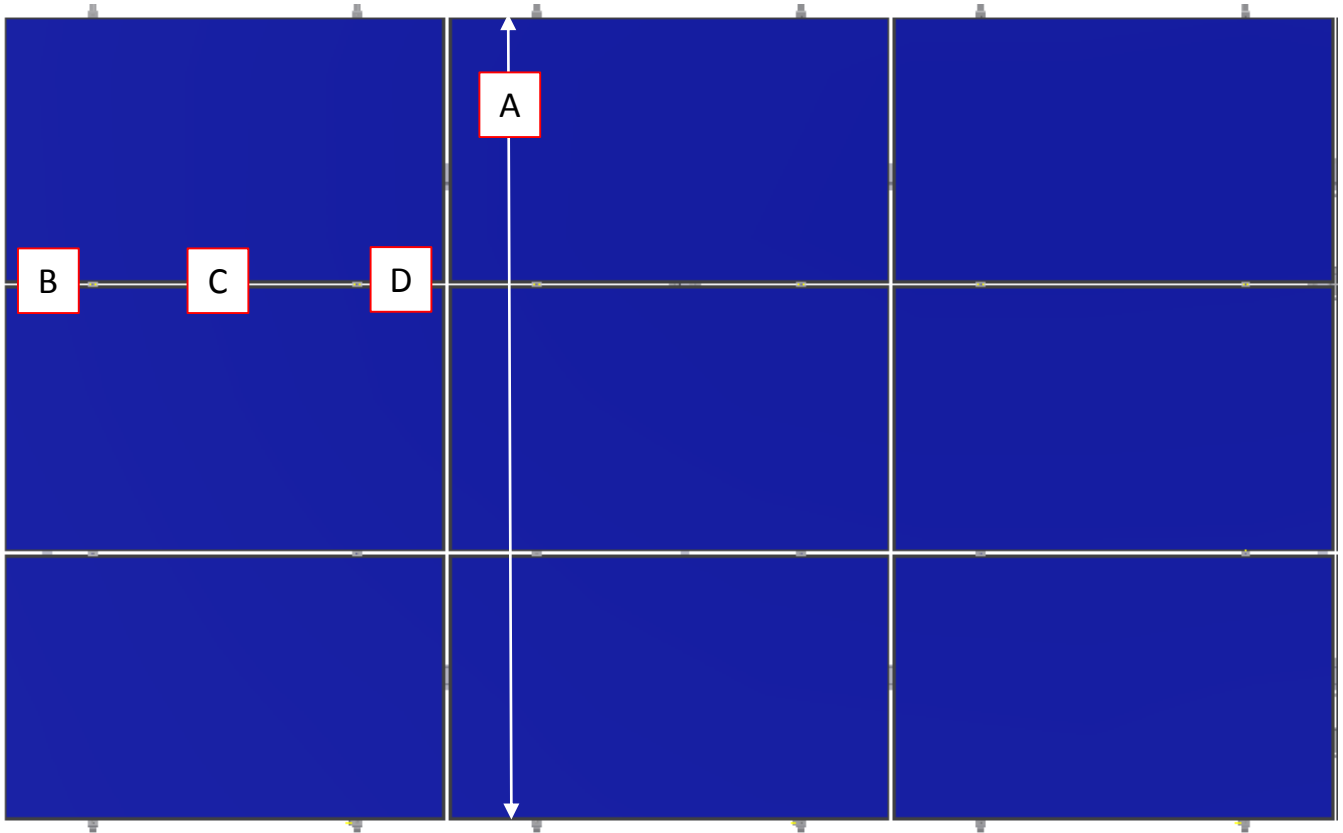

## Solar Panel Seam Gasket Lengths:

In order to minimize cuts and intersection splices the longest continuous gasket runs should be installed first.

### A. North-south panel seam

= This is the longest continuous panel seam and should be sealed first.

= The Gasket is supplied in a 26-ft (8m) long roll. The most typical solar panel size used for residential installations is 65 inches by 39 inches, while the common size for commercial applications is 77 inches by 39 inches.

### B. Corner to Mid-Clamp = Cut gasket to measured length from the corner of the module to the end of the mid-clamp.

### C. Mid-Clamp to Mid-Clamp = Cut gasket to measured length from mid-clamp to mid-clamp.

### D. Mid-Clamp to Corner = Cut gasket to measured length from mid-clamp to end of panel.

# Solar Panel Seam Gasket Installation Tips

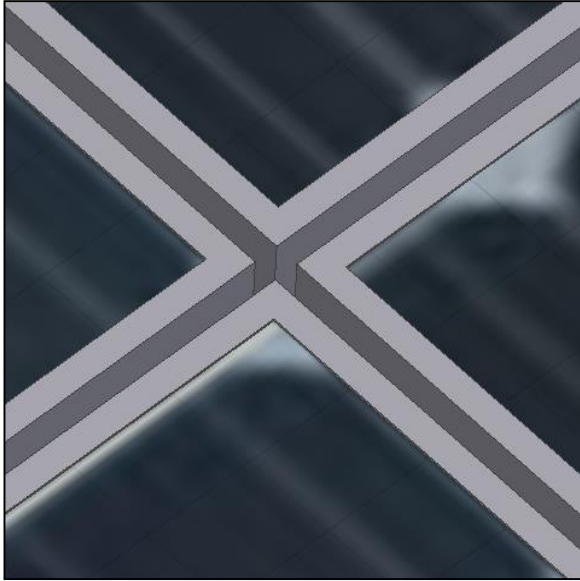

Aluminum frame should be clean and free of dirt and debris.



Install the EPDM Gasket by pushing the gasket in the gap between the panels.

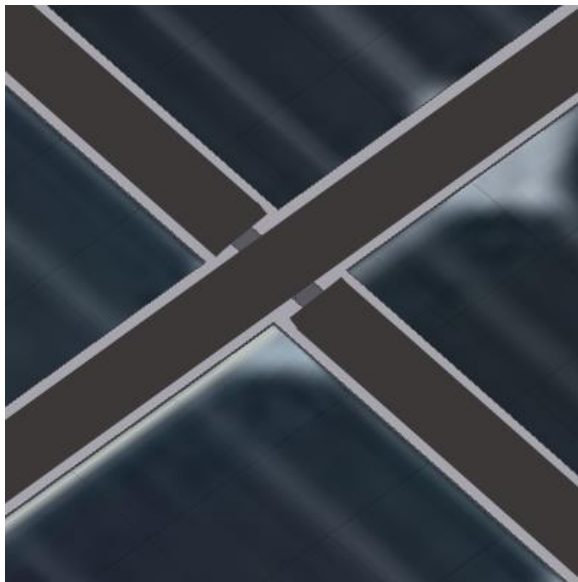

Install the EPDM Gasket leaving a 1/4 inch gap at the ends of the gasket.

**Tip:** Use soapy water as a lubricant to ease the gasket installation

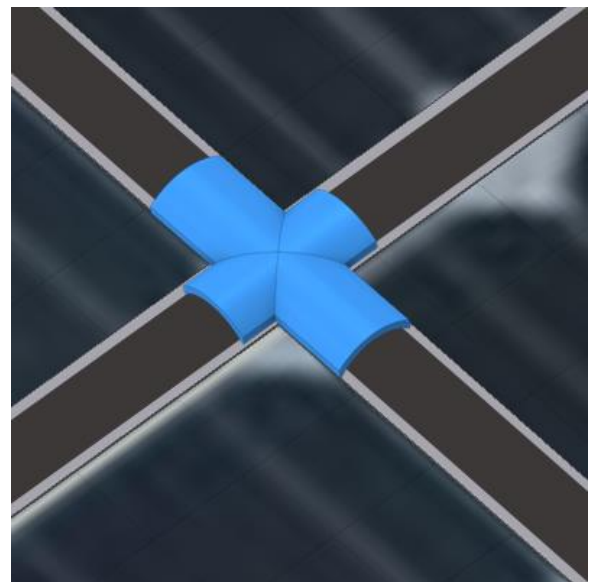

Use a copious amount of Sealant on the bottom side of the Glue-on Intersection Gasket (C10041-002). Remove excess Sealant from panel glass.

# Solar Panel Seam Gasket Installation Tips



Aluminum frame should be clean and free of dirt and debris.



Install the EPDM Gasket by pushing the gasket in the gap between the panels.



Install the EPDM Gasket leaving a 1/4 inch gap at the ends of the gasket.

**Tip:** Use SunModo Bottom Clamps to avoid gasket joints around the Mid Clamps.

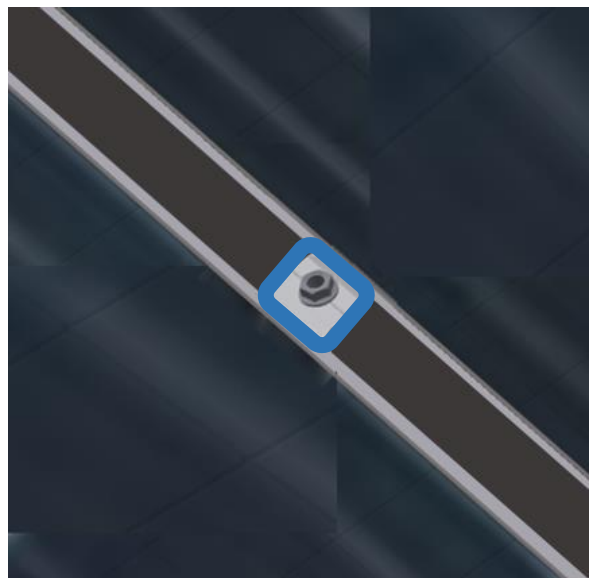

Use a copious amount of Sealant around the Mid Clamp. Remove excess Sealant from panel glass.

# Solar Panel Seam Gasket Installation Tips



Aluminum frame should be clean and free of dirt and debris.

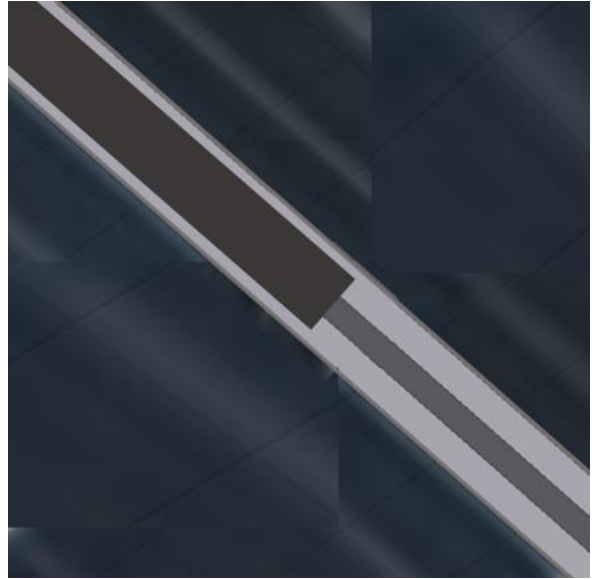

Install the EPDM Gasket by pushing the gasket in the gap between the panels.

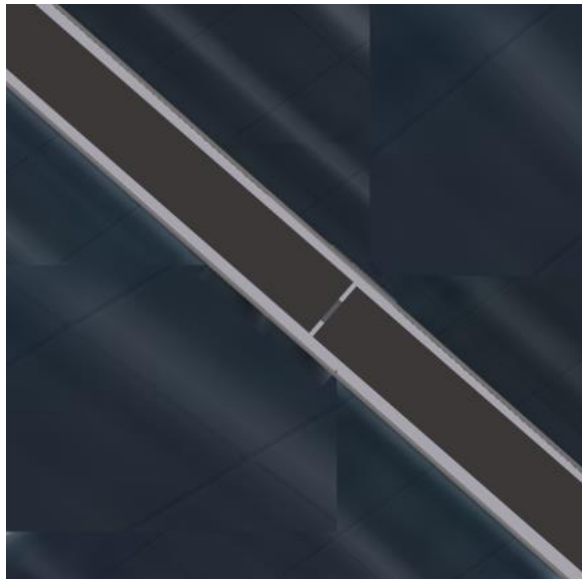

Install the EPDM Gasket leaving a small inch gap at the ends of the gasket.

**Tip:** Minimize butt joints, and additional sources of leaks, by using continuous gasket.



Use a copious amount of Sealant in and around the butt joint. Remove excess Sealant from panel glass.



# Solar Panel Seam Gasket Installation Tips

Eliminate the gasket joints around the Mid Clamps: SunModo's Bottom Clamp Kit can be used to secure the panels to the rail.

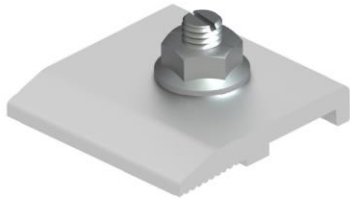

K10242-001

HR (1/4 hardware) Bottom Clamp Kit

K10242-002

SB (3/8 hardware) Bottom Clamp Kit

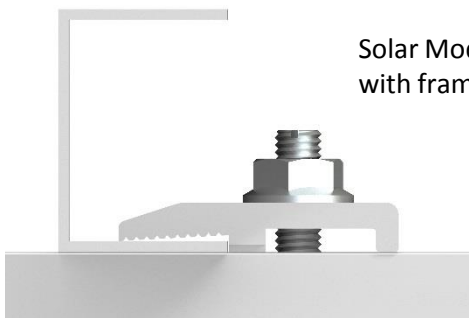

Solar Module shown  
with frame only

